

2020. / 2021.



Sveučilište u Rijeci  
TEHNIČKI FAKULTET

# GODIŠNJAK TEHNIČKOG FAKULTETA

Sveučilišta u Rijeci



University of Rijeka  
FACULTY OF ENGINEERING

**ANNUAL REPORT OF  
THE FACULTY OF  
ENGINEERING**  
University of Rijeka

**GODIŠNJAK  
TEHNIČKOG FAKULTETA**

ANNUAL REPORT  
OF THE FACULTY OF  
ENGINEERING

Sveučilište u Rijeci  
University of Rijeka

**2020./2021.**  
**2020/2021**



*Sveučilište u Rijeci  
Tehnički fakultet*

*University of Rijeka  
Faculty of Engineering*

UDK / UDC: 378.662 (497.5 Rijeka)(058)

**God.** / Vol. 14  
**Str.** / P. 1-286 Rijeka, 2021.

**IZDAVAČ** | PUBLISHER:  
Sveučilište u Rijeci, Tehnički fakultet  
/ University of Rijeka, Faculty of Engineering

**GLAVNI UREDNIK** | EDITOR-IN-CHIEF:  
doc. dr. sc. / Assist. Prof. D. Sc. Sanjin Krščanski

**ZAMJENICA UREDNIKA** | DEPUTY EDITOR:  
asist. / Asist. Ivana Lučin

**UREDNIČKI ODBOR** | EDITORIAL BOARD:  
prof. dr. sc. / Prof. D. Sc. Duško Pavletić;  
prof. dr. sc. / Prof. D. Sc. Anica Trp;  
prof. dr. sc. / Prof. D. Sc. Marina Franulović;  
izv. prof. dr. sc. / Assoc. Prof. D. Sc. Ivan Štajduhar;  
doc. dr. sc. / Assist. Prof. D. Sc. Sanjin Krščanski;  
asist. / Assist. Ivana Lučin; asist. dr. sc. / Assist. D. Sc. Luka Grbčić  
asist. dr. sc. / Assist. D. Sc. Diego Sušan; asist. / Assist. Damjan Banić

**LEKTURA** | PROOFREADING:  
Marta Lončarević, prof., dipl. knjižničarka / Prof., Grad. Librarian  
(hrvatski / Croatian);  
Adverbium d.o.o. (engleski / English)

**PRIJELOM** | LAYOUT DESIGN:  
Lea Grgurić  
Kreativ Media Grupa d.o.o.

**ADRESA UREDNIŠTVA** | EDITORIAL BOARD ADDRESS:  
Godišnjak Tehničkog fakulteta Sveučilišta u Rijeci  
51000 Rijeka, Vukovarska 58, Hrvatska / Croatia

Tel.: +385 (0)51 / 651 - 444 Fax: +385 (0)51 / 651 - 416  
dekanat@riteh.hr | www.riteh.uniri.hr

**UČESTALOST IZLAŽENJA** | PUBLISHED:  
Jednom godišnje / Annually

**TISAK** | PRINTED BY:  
TEHNIČAR-COPYSERVIS d.o.o.

**NAKLADA** | EDITION:  
300 primjeraka / pcs.

## PREDGOVOR DEKANA

| DEAN'S PREFACE.....7

## 1 OPĆE INFORMACIJE

| GENERAL INFORMATION..... 11

## 2 FAKULTET U AKADEMSKOJ GODINI 2020./2021.

| FACULTY IN THE ACADEMIC YEAR 2020/2021 .....20

### 2.1 opće informacije

| general information .....20

### 2.2 studenti nagrađeni u ak. godini 2020./2021.

| awarded students in the 2020/2021 academic year .....24

### 2.3 studentski završni i diplomski radovi

| student undergraduate and graduate theses .....26

### 2.4 alumni tfr.....

58

### 2.5 časopis "engineering review"

| the journal engineering review .....62

### 2.6 doktorske disertacije obranjene u akademskoj godini 2020./2021

| doctoral dissertations defended in academic year 2020/2021 .....64

### 2.7 aktivni projekti

| active projects .....78

#### 2.7.1 hrzz projekti

| hrzz projects.....78

#### 2.7.2 EU projekti

| EU projects .....89

### 2.8 aktivnosti, zbivanja i konferencije

| activities, events and conferences ..... 110

#### 2.8.1 job.fair i dan otvorenih laboratorija 2020

| job.fair and open lab day 2020..... 110

#### 2.8.2 my first conference 2021

..... 112

#### 2.8.3 24. simpozij SORTA

| 24<sup>th</sup> SORTA symposium ..... 114

#### 2.8.4 GNSS konferencija 2021

| gnss conference 2021..... 116

#### 2.8.5 29<sup>th</sup> summer school on image processing 2021

..... 118

#### 2.8.6 11. susreti hrvatskog društva za mehaniku

| 11<sup>th</sup> meeting of the croatian society of mechanics..... 121

## 3 STUDIJSKI PROGRAMI NA FAKULTETU

| STUDY PROGRAMMES AT THE FACULTY ..... 126

## 4 DEKANAT

| DEAN'S OFFICE ..... 146

## 5 ZAVODI

| DEPARTMENTS..... 150

### 5.1 zavod za automatiku i elektroniku

| department of automation and electronics ..... 151

5.2 zavod za brodogradnju i inženjerstvo morske tehnologije   department of naval architecture and ocean engineering.....	163
5.3 zavod za elektroenergetiku   department of electric power systems .....	173
5.4 zavod za industrijsko inženjerstvo i menadžment   department of industrial engineering and management.....	179
5.5 zavod za konstruiranje u strojarstvu   department of mechanical engineering design .....	187
5.6 zavod za matematiku, fiziku i strane jezike   department of mathematics, physics and foreign languages.....	201
5.7 zavod za materijale   department of materials science and engineering .....	207
5.8 zavod za mehaniku fluida i računarsko inženjerstvo   department of fluid mechanics and computational engineering.....	213
5.9 zavod za računarstvo   department of computer engineering .....	219
5.10 zavod za tehničku mehaniku   department of engineering mechanics.....	233
5.11 zavod za termodinamiku i energetiku   department of thermodynamics and energy engineering.....	243
<b>6 STRUČNE SLUŽBE</b>   PROFESSIONAL AND ADMINISTRATIVE STAFF .....	<b>255</b>
6.1 knjižnica   library .....	256
6.2 računalni centar   computer center .....	258
6.3 financijska služba   accounting division.....	260
6.4 služba nabave i komercijale   procurement and commerciale office .....	262
6.5 služba općih i kadrovskih poslova   general and personnel office.....	263
6.6 služba studentske evidencije   student's registrar and affairs office .....	266
6.7 tehnička služba   technical and maintenance services.....	267
<b>7 STUDENTSKE AKTIVNOSTI</b>   STUDENT ACTIVITIES .....	<b>270</b>
7.1 studentski zbor tehničkog fakulteta   student council at the faculty of engineering.....	271
7.2 IEEE studentski ogranak sveučilišta u rijeci   IEEE university of rijeka student branch .....	274
7.3 natjecanje timova studenata Informatičara hrvatskih sveučilišta 2020   croatian collegiate programming contest 2020 .....	277
7.4 riteh racing team.....	278
7.5 riteh drone team .....	281
7.6 riteh web team.....	282

# PREDGOVOR

## DEKANA

### DEAN'S PREFACE



Poštovani studenti, djelatnici, suradnici i prijatelji Tehničkog fakulteta,

Godišnjak koji imate u rukama daje pregled aktivnosti i postignuća naših studenata, djelatnika i suradnika ostvarenih tijekom akademske godine 2020./2021., ujedno šezdeset i prve godine postojanja i djelovanja Tehničkog fakulteta Sveučilišta u Rijeci.

Usprkos otežanim i izmijenjenim uvjetima rada uslijed pandemije uzrokovane korona virusom, tijekom ove akademske godine provedene su brojne aktivnosti. Usvojena je Strategija Tehničkog fakulteta za razdoblje od 2021. do 2025. godine kao temeljni strateški dokument kojim se daje okvir za razvoj Fakulteta. Provedeno je osuvremenjivanje studijskih programa preddiplomskih i diplomskih sveučilišnih studija strojarstva, brodogradnje, elektrotehnike i računarstva. Revidirane su upisne kvote na svim studijima, a posebno bih istaknuo povećanje kvote na studiju računarstva, i to za 40 %. Radi promocije naših studija i privlačenja budućih studenata, napravljena je nova web stranica namijenjena upisima.

Uz neprekinuto ostvarivanje svoje obrazovne uloge, značajna je znanstvena i stručna djelatnost Fakulteta. U ovoj je akademskoj godini, pored nastavka rada na prethodno odobrenim znanstvenoistraživačkim projektima, započelo financiranje dodatnih dvaju istraživačkih i jednog uspostavno-istraživačkog projekata Hrvatske zaklade za znanost. S realizacijom je započeto na tri IRI-2 projekta, Sveučilište u Rijeci odobrilo je financiranje projekata za troje naših mladih znanstvenika, odobreno je financiranje jednog projekta temeljem natječaja Hrvatske zaklade za znanost pod nazivom Zdravstveni, gospodarski i obrazovni učinci pandemije COVID-19, a s realizacijom je započeo i EU projekt Digital Empowering Through HPC Education.

Dear students, members of staff, associates and friends of the Faculty of Engineering,

The Annual Report that you have in your hands gives an overview of the activities and achievements of our students, staff and associates during the 2020/2021 academic year, which also marked the 60th anniversary of the existence and work of the Faculty of Engineering of the University of Rijeka.

Even though our working conditions have changed and become more difficult due to the coronavirus pandemic, numerous activities were carried out during this academic year. The Strategy of the Faculty of Engineering for the 2021-2025 period was adopted as the basic strategic document which provides a framework for the development of the Faculty. The undergraduate and graduate university study programmes in Mechanical Engineering, Naval Architecture, Electrical Engineering, and Computer Engineering have been modernised. Enrolment quotas for all study programmes have been revised, and I would especially like to point out the 40% increase in the Computer Engineering quota. Furthermore, a new enrolment website has been created to promote our study programmes and attract future students.

In addition to continuing to fulfil its educational role, the Faculty also carries out significant scientific and professional activities. This academic year saw the continuation of previously approved scientific research projects, the beginning of financing for two additional research and one establishment research project of the Croatian Science Foundation, and the start of implementation of three IRI-2 projects. The University of Rijeka has approved funding of projects for three of our young scientists. Furthermore, funding has been approved for a project

Slijedom prijave na natječaj Hrvatske zaklade za znanost „Projekt razvoja karijera mladih istraživača – izobrazba novih doktora znanosti“ prihvaćeno je financiranje šest doktoranda. Dodatno, naši znanstvenici se, kao suradnici i istraživači, uključuju u brojne projekte na drugim institucijama.

Ova zapažena znanstvena aktivnost dijelom je rezultat i kontinuiranog višegodišnjeg sustavnog ulaganja Fakulteta u unaprjeđenje uvjeta rada u nastavnim i laboratorijskim prostorima. U akademskoj godini 2020./2021. uloženo je više od četiri milijuna kuna u nabavu nove laboratorijske opreme, razvoj računalne infrastrukture i održavanje prostora Fakulteta. Svi prostori namijenjeni održavanju nastave opremljeni su opremom koja omogućava istovremenost održavanja nastave u učionicama i prijenos na daljinu, a predavaonice i informatički kabineti opremljeni su sustavom kontrole pristupa.

Pored spomenutih, prošla je akademska godina bila obilježena i brojnim drugim događanjima.

Obilježena je 60. obljetnica Fakulteta. Zbog nemogućnosti održavanja uobičajenih okupljanja povodom svečanosti obilježavanja dana Fakulteta, pripremljena je posebna online platforma na kojoj se, u virtualnom okruženju, tijekom studenog 2020. godine predstavio Fakultet, održan je Sajam poslova i Dani otvorenih laboratorija. Svima zainteresiranima omogućen je uvid u rad u laboratorijima Fakulteta i kontakti s potencijalnim poslodavcima. U tom periodu i tom prilikom Fakultet je bio pojačano prisutan u medijima.

Fakultet je uspješno organizirao 24. Symposium on the Theory and Practice of Shipbuilding – in memoriam prof. Leopold Sorta. Simpozij je održan u listopadu 2020. godine u online okruženju. Na simpoziju je bilo registrirano više od 150 autora i sudionika s 37 radova. Kao suorganizator, Fakultet je sudjelovao u organizaciji i provedbi 14th Baška GNSS Conference, održane u Baški na otoku Krku u svibnju 2021. godine. U srpnju 2021. godine, uz pridržavanje posebnih epidemioloških mjera, uspješno je održan i Summer School on Image Processing, godišnji skup istraživača i stručnjaka iz područja analize slike i strojnog vida. Tijekom rujna 2021. godine, Fakultet je ugostio 11. susret Hrvatskog društva za mehaniku.

Naši studenti dobitnici su zapaženih nagrada i priznanja, za istaknuti je kolegicu Mateu Ignatoski, dobitnicu Rektorove nagrade za stručni/znanstveni/umjetnički rad u kategoriji prirodnih i tehničkih znanosti i kolegicu Mateju Napravnik, studenticu 2. godine diplomskog sveučilišnog

based on a call by the Croatian Science Foundation entitled Health, Economic and Educational Effects of the COVID-19 Pandemic. The EU project Digital Empowering Through HPC Education has also started.

Following applications to the “Career Development Project for Young Researchers – Training of New Doctors of Science” of the Croatian Science Foundation, the funding of six doctoral students was approved. In addition, our scientists are involved in numerous projects at other institutions as assistants and researchers.

This notable scientific activity is partly the result of the many years that the Faculty has been systematically investing in improving working conditions at its teaching and laboratory premises. In the 2020/2021 academic year, more than four million kuna was invested in purchasing new laboratory equipment, developing computer infrastructure and maintaining Faculty premises. All rooms intended for teaching have been provided with equipment that allows simultaneous live and online teaching, and classrooms and computer rooms have been equipped with an access control system.

In addition to the above, the previous academic year was marked by numerous other events.

The Faculty celebrated its 60th anniversary. As it was not possible to hold the usual Faculty Day events, a special online platform was prepared on which the Faculty presented itself in November 2020. The Job Fair and Open Laboratory Days were also held in a virtual environment, providing those interested with an insight into the work of the laboratories of the Faculty and contacts with potential employers. On these occasions, the Faculty was the subject of significant media coverage.

The Faculty successfully organised the 24th Symposium on the Theory and Practice of Shipbuilding in memory of Professor Leopold Sorta. The symposium was held in October 2020 in an online environment, and there were more than 150 registered authors and participants, with a total of 37 papers. As a co-organiser, the Faculty participated in the organisation and holding of the 14th Baška GNSS Conference, which took place in Baška on the island of Krk in May 2021. In July 2021, by adhering to special epidemiological measures, the Summer School on Image Processing was successfully held, an annual meeting of researchers and experts in the field of image analysis and machine vision. In Sep-

studija računarstva, dobitnicu Rektorove nagrade za izvrsnost. Kolegica Napravnik je ujedno proglašena i studenticom generacije Sveučilišta u Rijeci. S posebnim ponosom ističem da je ovo druga godina zaredom proglašenja studentice Tehničkog fakulteta studenticom generacije Sveučilišta u Rijeci. Prošle godine to je bila kolegica Anja Mirić, studentica diplomskog sveučilišnog studija strojarstva.

U brojnim aktivnostima nastavnika i studenata vezanim uz poslijediplomske doktorske studije na našem Fakultetu, a koje su rezultirale većim brojem obranjenih doktorskih disertacija, za istaknuti je prvu doktorsku disertaciju izrađenu i obranjenu po skandinavskom modelu, kolege dr. sc. Luke Grbčića, iz područja Tehničkih znanosti, polja Temeljnih tehničkih znanosti i prvu obranjenu doktorsku disertaciju (doktorskom) studiju iz područja Tehničkih znanosti, polja Računarstvo, kolege dr. sc. Diega Sušnja.

Nisu izostale niti aktivnosti naših studenata u studentskim timovima. Aktivni su bili članovi Riteh Racing Teama, Riteh Drone Teama i Riteh Web Teama koji su, usprkos ograničenjima nametnutih pandemijom, uspjeli odraditi brojne aktivnosti.

Nastavljeno je s aktivnim poticanjem znanstvene izvrsnosti djelatnika Tehničkog fakulteta zbog povećanja kvalitete znanstvenih publikacija doprinosom potpora, kao i sufinanciranje i podrška studentskim timovima Fakulteta i podrška studentskim sportskim aktivnostima.

Auditom koji je provela neovisna certifikacijske ustanova potvrđena je učinkovitost sustava upravljanja kvalitetom prema normi ISO 9001, čime je potvrđena visoka razina uređenosti naših procesa podrške.

Na kraju, koristim ovu priliku da svim studentima, djelatnicima i suradnicima Tehničkog fakulteta čestitam šezdeset i prvu obljetnicu Fakulteta i zahvalim se na njihovom doprinosu pri razvoju naše ustanove. Posebno zahvaljujem svima koje u ovom kratkom uvodniku nisam spomenuo, a svojim doprinosom i zapaženim rezultatima to svakako zaslužuju.

tember 2021, the Faculty also hosted the 11th meeting of the Croatian Society of Mechanics.

Our students were the recipients of prestigious awards and recognition, for example Matea Ignatoski, winner of the Rector's Award for Professional/Scientific/Artistic Work in the category of natural and technical sciences, and Mateja Napravnik, a 2nd-year graduate student of Computer Engineering, who won the Rector's Award for Excellence, and who was also declared Student of the Generation of the University of Rijeka. I am especially proud to point out that this is the second year in a row that a student of the Faculty of Engineering has been declared Student of the Generation of the University of Rijeka. Last year, it was Anja Mirić, a graduate student of Mechanical Engineering.

As far as the activities of teachers and students related to postgraduate doctoral studies at our Faculty are concerned, a large number of doctoral dissertations were successfully defended, two of which are particularly worth mentioning: the first doctoral dissertation prepared and defended according to the Scandinavian model by Luka Grbčić, D. Sc. in the area of Engineering Sciences (in the field of Fundamental Engineering Sciences), and the first doctoral dissertation defended as part of our postgraduate university (doctoral) study programme in the area of Engineering Sciences (in the field of Computer Engineering) by Diego Sušan, D. Sc..

Our students were also active in student teams. Members of the Riteh Racing Team, the Riteh Drone Team, and the Riteh Web Team managed to carry out numerous activities despite the restrictions imposed by the pandemic.

We continued to actively encourage scientific excellence in staff at the Faculty of Engineering in terms of increased quality of scientific publications by awarding grants. We also co-financed and supported the Faculty's student teams, as well as student sports activities.

An audit conducted by an independent certification body confirmed the effectiveness of our quality management system in line with the ISO 9001 standard, which attests to the robustness of our support processes.

Finally, I would like to take this opportunity to congratulate all the students, members of staff and associates of the Faculty of Engineering on the sixty-first anniversary of the Faculty, and to thank them for their contribution to the development of our institution. I would especially like to thank everyone whom I have not mentioned in

Veliku zahvalnost na uloženom trudu i naporu u prikupljanju, pripremi i obradi građe Godišnjaka izražavam radnoj skupini koju je, kao glavni urednik, predvodio doc. dr. sc. Sanjin Krščanski, uz asistente Ivanu Lučin, Damjana Banića, Diega Sušnja i Luku Grbčića.

Želim vam ugodno čitanje ovogodišnjeg Godišnjaka Tehničkog fakulteta.

U Rijeci 30. rujna 2021.  
Dean  
Prof. dr. sc. Duško Pavletić

*this short editorial, but who certainly deserve to be mentioned for their contributions and notable results.*

*I would like to extend my thanks to the working group led by the main editor Assistant Professor Sanjin Krščanski, D. Sc., and assistants Ivana Lučin, Damjan Banić, Diego Sušan and Luka Grbčić for their effort in collecting, preparing and editing the material for this Annual Report.*

*I hope you will enjoy reading this year's Annual Report of the Faculty of Engineering.*

Rijeka, 30 September 2021  
Dean  
Professor Duško Pavletić, D. Sc.

## 1 OPĆE INFORMACIJE GENERAL INFORMATION

Tehnički fakultet Sveučilišta u Rijeci stožerna je visokoškolska i znanstvenoistraživačka institucija na području tehničkih znanosti, ne samo na Sveučilištu u Rijeci nego i u regiji u kojoj djeluje, konkurentna na europskom i svjetskom tržištu znanja. Fakultet danas objedinjuje djelatnost 11 zavoda, i to:

- » Zavoda za automatiku i elektroniku  
Department of Automation and Electronics
- » Zavoda za brodogradnju i inženjerstvo morske tehnologije  
Department of Naval Architecture and Ocean Engineering
- » Zavoda za elektroenergetiku  
Department of Electrical Power Engineering
- » Zavoda za industrijsko inženjerstvo i menadžment  
Department of Industrial Engineering and Management
- » Zavoda za konstruiranje u strojarstvu  
Department of Mechanical Engineering Design
- » Zavoda za matematiku, fiziku i strane jezike  
Department of Mathematics, Physics and Foreign Languages
- » Zavoda za materijale  
Department of Materials Science and Engineering
- » Zavoda za mehaniku fluida i računarstvo inženjerstvo  
Department of Fluid Mechanics and Computational Engineering
- » Zavoda za računarstvo  
Department of Computer Engineering
- » Zavoda za tehničku mehaniku  
Department of Engineering Mechanics
- » Zavoda za termodinamiku i energetiku  
Department of Thermodynamics and Energy Engineering

The Faculty of Engineering of the University of Rijeka is a leading higher education, scientific and research institution in the field of engineering sciences at both the University of Rijeka and in the region where is situated. It is competitive on the European and world knowledge market. The Faculty encompasses 11 departments:

U sklopu zavoda djeluje 36 katedri i 50 laboratorija, a na Fakultetu djeluju i Računalni centar, Knjižnica, Financijska služba, Služba nabave i komercijale, Služba općih i kadrovskih poslova, Služba studentske evidencije i Tehnička služba. Od 189 zaposlenika 81 ih je u znanstveno-nastavnim, 7 u nastavnim i 43 u suradničkim zvanjima, 6 je zaposlenika na projektima Hrvatske zaklade za znanost, a 44 je djelatnika u administrativnim i stručnim službama. Na DATACROSS projektima i EU projektima zaposleno je 8 djelatnika. Na Fakultetu radi i veći broj vanjskih suradnika. Fakultet izvodi sveučilišne preddiplomske i sveučilišne diplomске studijske programe na području strojarstva, brodogradnje, elektrotehnike i računarstva i stručne preddiplomske studijske programe na području strojarstva, brodogradnje i elektrotehnike, kao i trogodišnji treći ciklus ob-

The departments include 36 sections and 50 laboratories, and the Faculty also has a Computing Centre, Library, Accounting Division, Procurement Office, General and Personnel Office, Student Affairs Office, and Technical Service. Of a total number of 189 employees, 81 are in teaching-research, 7 in teaching, and 43 in associate positions, while 6 members of staff work on projects funded by the Croatian Science Foundation, and 44 in the administrative and professional services. Eight members of staff work on DATACROSS and EU projects. The Faculty also engages a large number of external associates. The Faculty offers undergraduate and graduate university study programmes in mechanical engineering, naval architecture, electrical engineering and computer engineering, as well as undergraduate vocational study



razovanja koji omogućava stjecanje doktorata znanosti na području tehničkih znanosti, i to na polju strojarstva, brodogradnje, elektrotehnike, temeljnih tehničkih znanosti, interdisciplinarnih tehničkih znanosti i računarstva.

Do sada je na Tehničkom fakultetu u Rijeci diplome steklo 158 doktora znanosti, 95 magistara znanosti, 2899 diplomiranih inženjera (od čega 2335 strojarstva, 311 brodogradnje i 253 elektrotehnike), 1536 inženjera (od čega 717 strojarstva, 108 brodogradnje i 711 elektrotehnike), 1724 magistra inženjera (od čega 788 strojarstva, 136 brodogradnje, 593 elektrotehnike i 207 računarstva), 2347 sveučilišnih prvostupnika inženjera (od čega 1146 strojarstva, 166 brodogradnje, 672 elektrotehnike i 363 računarstva) i 754 stručnih prvostupnika inženjera (od čega 310 strojarstva, 71 brodogradnje i 373 elektrotehnike). Danas studira oko 1900 studenata.

Tehnički fakultet ima dugu tradiciju izdavanja znanstvenih i stručnih radova. Tiskanje Zbornika radova započinje još 1970. godine, a 1988. godine spomenuta edicija mijenja naziv u Zbornik Tehničkog fakulteta Rijeka. Naziv se ponovo mijenja 1995. godine u Engineering Review, a pod tim nazivom časopis se tiska i danas. Osim znanstvenih i stručnih radova, djelatnici Fakulteta objavili su i mnogobrojne knjige i udžbenike.

Na Fakultetu je od 24. studenog 2000. godine aktivan Alumni klub Tehničkoga fakulteta Sveučilišta u Rijeci (skraćeno ALUMNI TFR) osnovan s primarnim ciljem izgradnje i jačanja veza i suradnje između nekadašnjih studenata i Tehničkoga fakulteta, ali i osobne suradnje između nekadašnjih studenata. Predsjednik ALUMNI TFR je doc. dr. sc. Vedran Kirinčić.

Dobrovoljno darivanje krvi na Fakultetu provodi se još od 1980. godine. U novije doba ta hvaljevrijedna aktivnost provodi se organizirano od 2002. godine. U akademskoj godini 2020./2021., u suradnji sa transfuziologijom riječkog KBC-a, održane su 3 akcije (20. 10. 2020., 19. 01. 2021. i 19. 5. 2021.) pri čemu je prikupljeno oko 100 doza. Time je Tehnički Fakultet Sveučilišta u Rijeci, i u doba epidemije COVID-19, bio i ostao vodeći između nekoliko Fakulteta riječkog Sveučilišta na kojima se organizirano prikuplja ta dragocjena tekućina.

Na TFR od 1990. godine djeluje i podružnica Nezavisnog sindikata znanosti i visokog obrazovanja. Osim zaštite prava svojih članova, sindikalna podružnica na Fakultetu obavlja i zadatke iz djelokruga rada Zaposleničkoga vijeća koje na fakultetu nije konstituirano. Sindikalni povjerenik podružnice je prof. dr. sc. Roberto Žigulić.

programmes in mechanical engineering, naval architecture and electrical engineering. It also offers three-year doctoral study courses in Engineering Sciences in the fields of Mechanical Engineering, Naval Architecture, Electrical Engineering, Fundamental Engineering Sciences, Interdisciplinary Engineering Sciences and Computer Sciences.

So far, the Faculty of Engineering in Rijeka has awarded 158 Doctor of Science and 95 Master of Science degrees. It has also awarded 2,899 graduate engineering degrees (2,335 in Mechanical Engineering, 311 in Naval Architecture and 253 in Electrical Engineering). Of 1,536 engineering degrees, 717 were in Mechanical Engineering, 108 in Naval Architecture and 711 in Electrical Engineering. The Bologna programme has produced 1,724 master's degrees in engineering (788 in Mechanical Engineering, 136 in Naval Architecture, 593 in Electrical Engineering and 207 in Computer Engineering), 2,347 university bachelor's degrees in engineering (1,146 in Mechanical Engineering, 166 in Naval Architecture, 672 in Electrical Engineering and 363 in Computer Engineering), as well as 754 vocational bachelor's degrees in engineering (310 in Mechanical Engineering, 71 in Naval Architecture and 373 in Electrical Engineering). At present, around 1,900 students study at the Faculty.

The Faculty of Engineering has a long tradition in publishing scientific and technical papers. Proceedings was first published back in 1970, and from 1988 was named Proceedings of the Faculty of Engineering in Rijeka. In 1995, it was renamed Engineering Review, which it is still called today. In addition to scientific and technical papers, Faculty staff have published numerous books and textbooks.

The Alumni Club of the Faculty of Engineering in Rijeka (ALUMNI TFR) was founded on 24 November 2000 with the primary aim of establishing and strengthening ties and cooperation not only between alumni and the Faculty but also among alumni themselves. The chair of the ALUMNI TFR is Assistant Professor Vedran Kirinčić D. Sc.

Voluntary blood donation at the Faculty has been carried out since 1980. This laudable activity has been carried out in an organised manner since 2002. In the academic year 2020/2021, three such events were organised in collaboration with KBC Rijeka Transfusiology (20 October 2020, 19 January 2021, and 19 May 2021), when around 100 donations were received. With these actions, the Faculty of Engineering of the University of Rijeka, even during the COVID-19 pandemic, remained the leader among the faculties of the

University of Rijeka when it came to organising the giving of blood.

Since 1990, a subsidiary branch of the Independent Union of Science and Higher Education Employees of Croatia has been active at the Faculty of Engineering. Apart from protecting the rights of its members, the union branch carries out tasks of the Workers' Council, which has not been organised at the Faculty. The Union representative of the branch is Professor Roberto Žigulić D. Sc.







ZAVOD ZA AUTOMATIKU I ELEKTRONIKU PREDSTOJNIK Prof. dr. sc. Zlatan CAR	ZAVOD ZA BRODOGRADNINU I TEHNIČKE TEHNOLOGIJE PREDSTOJNIK Prof. dr. sc. Roko DEHALLA	ZAVOD ZA INDUSTRIJSKO INŽENJERSKO UPRAVLJANJE PREDSTOJNIK Prof. dr. sc. Zoran JURKOVIĆ	ZAVOD ZA KONSTRUIRANJE U STROJARSTVU PREDSTOJNIKA Doc. dr. sc. Kristina MARKOVIĆ	DEKANAT DEKAN Prof. dr. sc. Duško PAVLETIĆ	GLAVNI TAJNIK Tomo VERGIĆ	ZAVOD ZA MATEMATIKU I FIZIKU I STRANE JEZIKE PREDSTOJNIKA Prof. dr. sc. Nelida CRNARIĆ-ZIĆ	ZAVOD ZA MEHANIČKU FLUIDNU I HIDRAULIČKU INŽENJERSKTVO PREDSTOJNIK Prof. dr. sc. Lado KRANČEVIĆ	ZAVOD ZA RACIJONALNO RADIŠANJE PREDSTOJNIK Doc. dr. sc. Jonathan LERGA	ZAVOD ZA TEHNIČKU MEHANIČKU PREDSTOJNIK Prof. dr. sc. Goran TURKALJ	ZAVOD ZA TERMODINAMIKU I ENERGETIKU PREDSTOJNIK Prof. dr. sc. Branimir PAVKOVIĆ
Katedra za mjerne sistave VODITELJ Prof. dr. sc. Nino STOKOVIĆ	Katedra za otpor i propulziju broda VODITELJ Prof. dr. sc. Roko DEHALLA	Katedra za mjerenja i kvalitetu VODITELJ Prof. dr. sc. Duško PAVLETIĆ	Katedra za inženjersku grafiku VODITELJ Doc. dr. sc. Kristina MARKOVIĆ	Katedra za primijenjenu matematičku i fiziku VODITELJ Doc. dr. sc. Ivan DRAŽIĆ	Katedra za inženjersko materijala VODITELJ Izv. prof. dr. sc. Dario LUKIĆ	Katedra za mehaniku fluida i hidrauličke strojeve VODITELJ Prof. dr. sc. Zoran ČARIJA	Katedra za komunikacijske sistave VODITELJ Prof. dr. sc. Miroslav JOLER	Katedra za obradu konstrukcija VODITELJ Prof. dr. sc. Domagoj LANC	Katedra za obradu konstrukcija VODITELJ Prof. dr. sc. Domagoj LANC	Katedra za termotehniku VODITELJ Prof. dr. sc. Anica TRP
Katedra za signale i sistave VODITELJ Prof. dr. sc. Viktor SUJČIĆ	Katedra za projektiranje plovinih objekata VODITELJ Doc. dr. sc. Anton TURK	Katedra za organizaciju i operacijski menadžment VODITELJ Doc. dr. sc. Sađuro DOBOVIČEK	Katedra za konstruiranje i precizno inženjersko sredstva VODITELJ Prof. dr. sc. Robert BASAN	Katedra za primijenjenu matematičku i fiziku VODITELJ Doc. dr. sc. Ivan DRAŽIĆ	Katedra za strukturnu i svojstva materijala VODITELJ Doc. dr. sc. Svižana SMOKVIĆA HANZA	Katedra za mehaniku fluida i hidrauličke strojeve VODITELJ Prof. dr. sc. Siniša DRUŽETA	Katedra za programsku podršku VODITELJ Doc. dr. sc. Sandi LUBIĆ	Katedra za obradu konstrukcija VODITELJ Prof. dr. sc. Sinižin BRAUT	Katedra za obradu konstrukcija VODITELJ Prof. dr. sc. Sinižin BRAUT	Katedra za tehniku hlađenja VODITELJ Prof. dr. sc. Branimir PAVKOVIĆ
Katedra za elektroosobu, robotsku i automatičku VODITELJ Prof. dr. sc. Zlatan CAR	Katedra za tehnologiju i organizaciju brodogradnje VODITELJ Izv. prof. dr. sc. Marko HADJINA	Katedra za proizvodne tehnologije VODITELJ Prof. dr. sc. Goran ČUKOR	Katedra za konstruktivne elemente VODITELJ Prof. dr. sc. Marina FRANULIĆ	Katedra za primijenjenu matematičku i fiziku VODITELJ Doc. dr. sc. Ivan DRAŽIĆ	Katedra za strukturnu i svojstva materijala VODITELJ Doc. dr. sc. Svižana SMOKVIĆA HANZA	Katedra za mehaniku fluida i hidrauličke strojeve VODITELJ Prof. dr. sc. Siniša DRUŽETA	Katedra za inteligentne računarske sistave VODITELJ Prof. dr. sc. Ivo IPŠIĆ	Katedra za mehaniku tijela VODITELJ Prof. dr. sc. Marko CANADIJA	Katedra za obradu konstrukcija VODITELJ Prof. dr. sc. Marko CANADIJA	Katedra za brosko strojarstvo VODITELJ Prof. dr. sc. Tomislav MRKOVČIĆ
Katedra za elektroosobu, robotsku i automatičku VODITELJ Prof. dr. sc. Zlatan CAR	Katedra za konstrukciju plovinih objekata VODITELJ Prof. dr. sc. Albert ZAMARIN	Katedra za projektiranje procesa VODITELJ Prof. dr. sc. Miladen PERINIĆ	Katedra za konstruktivne elemente VODITELJ Prof. dr. sc. Marina FRANULIĆ	Katedra za primijenjenu matematičku i fiziku VODITELJ Doc. dr. sc. Ivan DRAŽIĆ	Katedra za strukturnu i svojstva materijala VODITELJ Doc. dr. sc. Svižana SMOKVIĆA HANZA	Katedra za mehaniku fluida i hidrauličke strojeve VODITELJ Prof. dr. sc. Siniša DRUŽETA	Katedra za inteligentne računarske sistave VODITELJ Prof. dr. sc. Ivo IPŠIĆ	Katedra za mehaniku tijela VODITELJ Prof. dr. sc. Marko CANADIJA	Katedra za obradu konstrukcija VODITELJ Prof. dr. sc. Marko CANADIJA	Katedra za brosko strojarstvo VODITELJ Prof. dr. sc. Tomislav MRKOVČIĆ
Katedra za elektroosobu, robotsku i automatičku VODITELJ Prof. dr. sc. Zlatan CAR	Katedra za konstrukciju plovinih objekata VODITELJ Prof. dr. sc. Albert ZAMARIN	Katedra za projektiranje procesa VODITELJ Prof. dr. sc. Miladen PERINIĆ	Katedra za konstruktivne elemente VODITELJ Prof. dr. sc. Marina FRANULIĆ	Katedra za primijenjenu matematičku i fiziku VODITELJ Doc. dr. sc. Ivan DRAŽIĆ	Katedra za strukturnu i svojstva materijala VODITELJ Doc. dr. sc. Svižana SMOKVIĆA HANZA	Katedra za mehaniku fluida i hidrauličke strojeve VODITELJ Prof. dr. sc. Siniša DRUŽETA	Katedra za inteligentne računarske sistave VODITELJ Prof. dr. sc. Ivo IPŠIĆ	Katedra za mehaniku tijela VODITELJ Prof. dr. sc. Marko CANADIJA	Katedra za obradu konstrukcija VODITELJ Prof. dr. sc. Marko CANADIJA	Katedra za brosko strojarstvo VODITELJ Prof. dr. sc. Tomislav MRKOVČIĆ

### Organizacijska struktura Fakulteta - zavodi i katedre

DEPARTMENT OF AUTOMATION AND ELECTRONICS DEPARTMENT HEAD Prof. D. Sc. Zlatan CAR	DEPT. OF NAVAL ARCHITECTURE AND OCEAN ENGINEERING DEPARTMENT HEAD Prof. D. Sc. Roko DEHALLA	DEPARTMENT OF INDUSTRIAL ENGINEERING AND MANAGEMENT DEPARTMENT HEAD Prof. D. Sc. Zoran JURKOVIĆ	DEPARTMENT OF MECHANICAL ENGINEERING DESIGN DEPARTMENT HEAD Asist. Prof. D. Sc. Kristina MARKOVIĆ	DEANS OFFICE DEAN Prof. D. Sc. Duško PAVLETIĆ	VICE DEANS Prof. D. Sc. Anica TRP Prof. D. Sc. Marina FRANULIĆ Assoc. Prof. D. Sc. Ivan STADUJAR	DEPARTMENT OF FLUID MECHANICS AND COMPUTATIONAL ENGINEERING DEPARTMENT HEAD Prof. D. Sc. Lado KRANČEVIĆ	DEPARTMENT OF COMPUTER ENGINEERING DEPARTMENT HEAD Asist. Prof. D. Sc. Jonathan LERGA	DEPARTMENT OF ENGINEERING MECHANICS DEPARTMENT HEAD Prof. D. Sc. Goran TURKALJ	DEPARTMENT OF THERMODYNAMICS AND ENERGY ENGINEERING DEPARTMENT HEAD Prof. D. Sc. Branimir PAVKOVIĆ
Chair of Measuring Systems HEAD Prof. D. Sc. Nino STOKOVIĆ	Chair of Research and Propulsion of the Ship HEAD Prof. D. Sc. Roko DEHALLA	Chair of Mesurement Techniques and Quality Systems HEAD Prof. D. Sc. Duško PAVLETIĆ	Chair of Engineering Graphics HEAD Asist. Prof. D. Sc. Kristina MARKOVIĆ	Chair of Applied Mathematics and Physics HEAD Asist. Prof. D. Sc. Ivan DRAŽIĆ	Chair of Material Engineering HEAD Asoc. Prof. D. Sc. Dario LUKIĆ	Chair of Fluid Mechanics and Hydraulic Engines HEAD Prof. D. Sc. Zoran ČARIJA	Chair of Communication Systems HEAD Prof. D. Sc. Miroslav JOLER	Chair of Structural Analysis HEAD Prof. D. Sc. Sinižin BRAUT	Chair of Thermodynamics and Thermotechnics HEAD Prof. D. Sc. Anica TRP
Chair of Signals and Systems HEAD Prof. D. Sc. Viktor SUJČIĆ	Chair of Vessel Design HEAD Asist. Prof. D. Sc. Anton TURK	Chair of Organisation and Operational Management HEAD Doc. dr. sc. Sađuro DOBOVIČEK	Chair of Construction and Precision Engineering HEAD Prof. D. Sc. Robert BASAN	Chair of Foreign Languages HEAD M. Sc. Eliza VELIČIĆ-JANIJEVIĆ, senilect	Chair of Structure and Material Properties HEAD Asist. Prof. D. Sc. Svižana SMOKVIĆA HANZA	Chair of Computational Engineering HEAD Prof. D. Sc. Siniša DRUŽETA	Chair of Software Engineering HEAD Asist. Prof. D. Sc. Sandi LUBIĆ	Chair of Machine Dynamics HEAD Prof. D. Sc. Sinižin BRAUT	Chair of Refrigeration HEAD Prof. D. Sc. Branimir PAVKOVIĆ
Chair of Electronics, Robotics and Automation HEAD Prof. D. Sc. Zlatan CAR	Technology and Organisation of Naval Architecture HEAD Asoc. Prof. D. Sc. Marko HADJINA	Chair of Production Equipment and Robotics HEAD Prof. D. Sc. Zoran JURKOVIĆ	Chair of Construction Elements HEAD Prof. D. Sc. Marina FRANULIĆ	Chair of Foreign Languages HEAD M. Sc. Eliza VELIČIĆ-JANIJEVIĆ, senilect	Chair of Structure and Material Properties HEAD Asist. Prof. D. Sc. Svižana SMOKVIĆA HANZA	Chair of Computational Engineering HEAD Prof. D. Sc. Siniša DRUŽETA	Chair of Intelligent Computing Systems HEAD Prof. D. Sc. Ivo IPŠIĆ	Chair of Solid Mechanics HEAD Prof. D. Sc. Marko CANADIJA	Chair of Marine Engineering HEAD Prof. D. Sc. Tomislav MRKOVČIĆ
Chair of Vessel Construction HEAD Prof. D. Sc. Albert ZAMARIN	Chair of the Vessel Dynamics HEAD Prof. D. Sc. Japna PRPIC-ORSIĆ	Chair of Production Technologies HEAD Prof. D. Sc. Goran ČUKOR	Chair of Power Transmissions and Industrial Transport Equipment and Devices HEAD Prof. D. Sc. Neven LOVRIN	Chair of Foreign Languages HEAD M. Sc. Eliza VELIČIĆ-JANIJEVIĆ, senilect	Chair of Structure and Material Properties HEAD Asist. Prof. D. Sc. Svižana SMOKVIĆA HANZA	Chair of Computational Engineering HEAD Prof. D. Sc. Siniša DRUŽETA	Chair of Intelligent Computing Systems HEAD Prof. D. Sc. Ivo IPŠIĆ	Chair of Solid Mechanics HEAD Prof. D. Sc. Marko CANADIJA	Chair of Marine Engineering HEAD Prof. D. Sc. Tomislav MRKOVČIĆ
Chair of Vessel Construction HEAD Prof. D. Sc. Albert ZAMARIN	Chair of the Vessel Dynamics HEAD Prof. D. Sc. Japna PRPIC-ORSIĆ	Chair of Production Technologies HEAD Prof. D. Sc. Goran ČUKOR	Chair of Power Transmissions and Industrial Transport Equipment and Devices HEAD Prof. D. Sc. Neven LOVRIN	Chair of Foreign Languages HEAD M. Sc. Eliza VELIČIĆ-JANIJEVIĆ, senilect	Chair of Structure and Material Properties HEAD Asist. Prof. D. Sc. Svižana SMOKVIĆA HANZA	Chair of Computational Engineering HEAD Prof. D. Sc. Siniša DRUŽETA	Chair of Intelligent Computing Systems HEAD Prof. D. Sc. Ivo IPŠIĆ	Chair of Solid Mechanics HEAD Prof. D. Sc. Marko CANADIJA	Chair of Marine Engineering HEAD Prof. D. Sc. Tomislav MRKOVČIĆ

TEHNIČKI FAKULTET RIJEKA
DEKAN
Prof. dr. sc. Duško PAVLETIĆ

URED DEKANA
VODITELJICA/UREDA
Sanja PRPIĆ

GLAVNI TAJNIK
Tomo VERGIĆ

TAJNICA PRODEKANA
Željka GULIĆ

PRODEKANI
Prof. dr. sc. Anica TRP
Prof. dr. sc. Marina FRANULOVIĆ
izv. prof. dr. sc. Ivan STAUDIHAH

POMOĆNICI DEKANA
Izv. prof. dr. sc. Neven BIJIĆ
Izv. prof. dr. sc. Marino BRČIĆ

KNJIŽNICA
VODITELJICA
Sanja OREŠKOVIĆ

RAČUNALNI CENTAR
VODITELJ
Domagoj CRUJENKO

FINANCIJSKA SLUŽBA
VODITELJICA
Ana MIRKOVIĆ PAVLOVIĆ

SLUŽBA NABAVE I KOMERCIJALE
VODITELJ
Robert MOHORIĆ

SLUŽBA OPĆIH I KADROVSKIH POSLOVA
VODITELJICA
Marijana BURIĆ REDŽOVIĆ

SLUŽBA STUDENTSKE EVIDENCIJE
VODITELJ
Žarko BURIĆ

TEHNIČKA SLUŽBA
VODITELJ
Enis KRULIĆ

KNJIŽNICA
DIP.L. KNJIŽNICAR
Mr. sc. Mario ŠOŠAR-BRNELIĆ

RAČUNALNI CENTAR
STRUČNI SURADNICI
Damir KOŠČIĆ
Tajana ŠKORJANEC

ODSEK KNJIGOVODSTVA
VODITELJ
Goran BRODARAC

ODSEK EKONOMATA
VODITELJ
Mladen OSTROGOVIĆ

KADROVSKI ODSEK
VODITELJICA
Snježana MIKULIĆ

SLUŽBA STUDENTSKE EVIDENCIJE
STRUČ. SURADNIK
Irina ČOŠIĆ

LABORATORIJ
LABORANTI
Bernardo BADURINA

RAČUNALNI CENTAR
TEHNIČKI SURADNIK
Siniša VUKOTIĆ

ODSEK FINANCISKE OPERATIVE
VODITELJICE
Ariana GREGUR
Ana ŠUTALO

ODSEK NABAVE
VODITELJICE
Tijana ČUPURDIJA
Bruna MARTINOVIC

ADMIN. TAJNICE
Valera BURIĆ MAROHNIĆ
Natalija FORGIĆ
Tina KAŽIĆ TADIĆ
Lovorka MALINIĆ
Ivana PETROVIĆ
Patricija VUKIĆ

KADROVSKI ODSEK
ADMIN. TAJNICE
Valera BURIĆ MAROHNIĆ
Natalija FORGIĆ
Tina KAŽIĆ TADIĆ
Lovorka MALINIĆ
Ivana PETROVIĆ
Patricija VUKIĆ

ODSEK STUDENTSKE REFERADE
Antonela ČALETA
Adriana MUŽDEKA PRODANOVIĆ
Tanja VELIČIĆ

RADIONICE ODRŽAVANJA
Josip JURASIĆ
Andrej MILUŠ

ZASTITA NA RADU
ZASTITA OD POŽARA
Frane POLEGUBIĆ

PISMOHRANA-POŠTA
REFERENTICA
Lidija PETRIČIĆ

ODSEK OPĆIH POSLOVA
SPREMAČICE
Snježana BAN
Marina DJAKOVIĆ
Marica GNATOVIĆ
Valentina KAIFEŠ
Mirjana KOŠPIĆ
Julijana NENADOVIĆ

ODSEK NABAVE
VODITELJICE
Tijana ČUPURDIJA
Bruna MARTINOVIC

ODSEK EKONOMATA
VODITELJ
Mladen OSTROGOVIĆ

ODSEK STUDENTSKE REFERADE
Antonela ČALETA
Adriana MUŽDEKA PRODANOVIĆ
Tanja VELIČIĆ

KUĆEPAZITELJI
Milenko PUJIĆ
Boris ŠEGOTA

### Organizacijska struktura Fakulteta - stručne službe

FACULTY OF ENGINEERING
DEAN
Prof. D. Sc. Duško PAVLETIĆ

DEAN'S OFFICE
OFFICE HEAD
Sanja PRPIĆ

SECRETARY GENERAL
Tomo VERGIĆ

VICE DEAN SECRETARY
Željka GULIĆ

VICE-DEANS
Prof. D. Sc. Anica TRP
Prof. D. Sc. Marina FRANULOVIĆ
Assoc. Prof. D. Sc. Ivan STAUDIHAH

DEAN'S ASSISTANTS
Assoc. Prof. D. Sc. Neven BIJIĆ
Assoc. Prof. D. Sc. Marino BRČIĆ

LIBRARY
HEAD
Sanja OREŠKOVIĆ

COMPUTER CENTER
HEAD
Domagoj CRUJENKO

ACCOUNTING DIVISION
HEAD
Ana MIRKOVIĆ PAVLOVIĆ

PROCUREMENT AND COMMERCIAL OFFICE
HEAD
Robert MOHORIĆ

GENERAL AND PERSONELL OFFICE
HEAD
Marijana BURIĆ REDŽOVIĆ

STUDENTS' REGISTRAR AND AFFAIRS OFFICE
HEAD
Žarko BURIĆ

TECHNICAL AND MAINTENANCE SERVICES
HEAD
Enis KRULIĆ

LIBRARY
GRAD. LIBRARIAN
M. Sc. Mario ŠOŠAR-BRNELIĆ

COMPUTER CENTER
ASSOCIATES
Damir KOŠČIĆ
Tajana ŠKORJANEC

ACCOUNTING SECTION
HEAD
Goran BRODARAC

SUPPLIES SECTION
HEAD
Mladen OSTROGOVIĆ

PERSONELL SECTION
HEAD
Snježana MIKULIĆ

STUDENTS' REGISTRAR AND AFFAIRS OFFICE
ASSOCIATE
Irina ČOŠIĆ

LABORATORY
LABORANTS
Bernardo BADURINA

COMPUTER CENTER
TECH. ASSOCIATE
Siniša VUKOTIĆ

FINANCIAL ACTIVITIES SECTION
HEAD
Ariana GREGUR
Ana ŠUTALO

PROCUREMENT SECTION
HEAD
Tijana ČUPURDIJA
Bruna MARTINOVIC

PERSONELL SECTION
ADMIN. SECRETARIES
Valera BURIĆ MAROHNIĆ
Natalija FORGIĆ
Tina KAŽIĆ TADIĆ
Lovorka MALINIĆ
Ivana PETROVIĆ
Patricija VUKIĆ

STUDENTS' REGISTRAR AND AFFAIRS OFFICE
ASSOCIATE
Irina ČOŠIĆ

MAINTENANCE WORKSHOPS
Josip JURASIĆ
Andrej MILUŠ

OCCUPATIONAL SAFETY
FIRE SAFETY
Frane POLEGUBIĆ

JANITORS
Miljenko PUJIĆ
Boris ŠEGOTA

GENERAL AFFAIRS SECTION
HOUSEKEEPERS
Snježana BAN
Marina DJAKOVIĆ
Marica GNATOVIĆ
Valentina KAIFEŠ
Mirjana KOŠPIĆ
Julijana NENADOVIĆ

ARCHIVE AND MAIL SERVICES
REGISTRY CLERK
Lidija PETRIČIĆ

GENERAL AFFAIRS SECTION
HOUSEKEEPERS
Snježana BAN
Marina DJAKOVIĆ
Marica GNATOVIĆ
Valentina KAIFEŠ
Mirjana KOŠPIĆ
Julijana NENADOVIĆ

# 2 FAKULTET U AKADEMSKOJ GODINI 2020./2021.

## THE FACULTY IN THE ACADEMIC YEAR 2020/2021

### 2.1 OPĆE INFORMACIJE

#### GENERAL INFORMATION

Na Tehničkom fakultetu, tijekom akademske godine 2020./2021., u različitim fazama studija aktivno je studiralo 1839 studenata, a svoj studij u tom razdoblju uspješno je završilo 204 magistra inženjera, 237 sveučilišnih prvostupnika i 55 stručnih prvostupnika. U istoj je akademskoj godini na našem Fakultetu devetero kandidata obranilo doktorsku disertaciju.

Unapređivanje uvjeta rada u nastavnim i laboratorijskim prostorima stalna je odrednica djelovanja Fakulteta, a u skladu sa svojim mogućnostima Fakultet neprekidno ulaže u podizanje kvalitete ovih bitnih resursa. U akademskoj godini 2020./2021. uloženo je više od četiri milijuna kuna za nabavu nove laboratorijske opreme, razvoj računalne infrastrukture i održavanje prostora Fakulteta s ciljem osuvremenjivanja i unaprjeđenja nastavnih i znanstveno-istraživačkih aktivnosti.

U akademskoj godini 2020./2021. nastava se je, zbog izvanrednih okolnosti uzrokovanih pandemijom korona virusa, većim dijelom, uključujući i provjere ishoda učenja tijekom nastave, održala korištenjem platforme BigBlueButton RiTeh za udaljeni pristup. Dio praktične nastave, za kojega je bilo nužno korištenje specijalizirane laboratorijske opreme, održao se je na Fakultetu. Također, na Fakultetu su se održale i obrane završnih i diplomskih radova. Kao i prethodne akademske godine, svi ispiti u ispitnim rokovima zimskog i ljetnog semestra, kao i u jesenskom ispitnom roku, održani su na Fakultetu uz strogo pridržavanje svih propisanih epidemioloških mjera. Time je osigurana kvaliteta vrednovanja i ocjenjivanja stečenih ishoda učenja.

U ožujku 2021. godine Fakultetsko vijeće prihvatilo je izmjene studijskih programa preddiplomskih i diplomskih sveučilišnih studija Brodogradnja, Elektrotehnika, Računarstvo i Strojarsvo te je cjelokupna dokumentacija upućena na daljnji postupak na Sveučilište. Senat Sveučilišta je u travnju 2021. godine donio odluku o prihvaćanju izmjena i dopuna studijskih programa. Usvojenim izmjenama i dopunama osuvremenjeni su sadržaji i literatura na većem broju kolegija, a neki od postojećih izbornih kolegija zamijenjeni su novima. Time je ostvareno povećanje atraktivnosti i prilagođavanje studijskih programa potrebama tržišta rada.

In the 2020/2021 academic year, there were 1,839 active students at the Faculty of Engineering, of whom 204 earned a master's degree, 237 a university bachelor's degree, and 55 a vocational bachelor's degree. In the same year, nine candidates defended their doctoral theses at our Faculty.

The improvement of the working conditions at our teaching and laboratory premises is a permanent concern of the Faculty. In line with its possibilities, the Faculty continuously invests in improving the quality of these important resources. In the 2020/2021 academic year, more than four million kuna was invested in the purchase of new laboratory equipment, the development of computer infrastructure, and the maintenance of the Faculty premises with the aim of modernising and improving teaching activities.

In the 2020/2021 academic year, the majority of classes, including continual assessments of learning outcomes during the semester, were held online using the BigBlueButton RiTeh platform for distance learning, due to the extraordinary circumstances caused by the coronavirus pandemic. Certain practical classes, for which it was necessary to use specialised laboratory equipment, were held at the Faculty. In addition, defences of final and graduate theses were also conducted at the Faculty. As in previous years, all exams in the winter, summer and autumn exam sessions were held at the Faculty, with strict adherence to all prescribed epidemiological measures, thus ensuring the quality of evaluation and assessment of acquired learning outcomes.

In March 2021, the Faculty Council accepted changes in the study programmes of undergraduate and graduate studies in naval architecture, electrical engineering, computing and mechanical engineering, and the relevant documentation was sent to the University for further consideration. In April 2021 the University Senate made a decision to accept the proposed changes and additions to existing studies. With the adopted changes and additions, the study content and literature on a large number of subjects were modernised and certain existing free elective subjects were replaced with new

Tijekom travnja, svibnja i lipnja 2021. godine, u organizaciji Fakulteta održane su pripreme za ispit iz A razine matematike na državnoj maturi za maturante kojima su studiji Tehničkog fakulteta bili prvi ili drugi izbor. Pripreme u trajanju od 40 nastavnih sati održali su nastavnici Fakulteta u virtualnom okruženju korištenjem platforme za udaljeni pristup.

Krajem rujna 2021. godine na daljinu je održano uvodno predavanje studentima prvih godina preddiplomskih sveučilišnih studija. Studentima koji započinju studij dane su osnovne informacije o studijima i studiranju. Na Fakultetu su u istome tjednu, u manjim grupama, pridržavajući se propisanih epidemioloških mjera, održani uvodni sastanci voditelja studija s novim studentima.

Pripremni seminari iz matematike i programiranja za nove studente, kao i prethodnih godina, održani su prije početka nastave u novoj akademskoj godini, u zadnjem tjednu rujna, zbog ponavljanja određenih sadržaja i pripreme studenata za studij. Pripremni su seminari u 2021. godini održani na daljinu u online okruženju.

Tijekom akademske godine 2020./2021. na Tehničkom fakultetu su se odvijale brojne istraživačke aktivnosti, većinom u okviru rada na znanstvenim projektima. Istraživanja su se provodila kroz projekte čiji je nositelj Tehnički fakultet: osam znanstvenih projekata Hrvatske zaklade za znanost, šest EU projekata, četiri COST projekta, tri ERASMUS+ projekta, tri IRI2 projekta, dva bilateralna znanstvena projekta i dva znanstvena projekta koje financirana gospodarski sektor. Brojnošću se ističu i UNIRI projekti kojih ima čak dvadeset i osam i dodatno dvije potpore UNIRI plus, tri projekta za mlade znanstvenike i jedan COVID projekt. Uz ove projekte, naši znanstvenici sudjeluju na brojnim znanstveno-istraživačkim projektima kao dio tima drugih nositelja projekata na Sveučilištu i izvan njega. Rezultati istraživanja znanstvenika diseminirani su prilikom sudjelovanja na brojnim konferencijama i kroz objavu radova u časopisima, od kojih je veliki broj klasificiran u najvišoj kategoriji. Uz četiri konferencije koje su održane u organizaciji ili uz partnerstvo fakulteta, naši znanstvenici sudjeluju u organizacijskim i znanstvenim odborima velikog broja znanstvenih skupova. Posebno smo ponosni na doktorsku konferenciju My First Conference koja je i ove godine pokazala visoku kvalitetu, svestranost i interdisciplinarnost u istraživanjima doktoranda Tehničkog fakulteta, a koja se ove godine odvijala u organizaciji Pomorskog fakulteta i ostvarila međunarodni karakter. Na konferenciji, osim prezentacija vlastitih istraživanja, naši doktorandi sudjeluju u organizacijskom odboru i u vođenju pojedinih sekcija.

Tijekom akademske godine 2020./2021., Tehnički fakultet nastavlja s realizacijom mobilnosti

ones, which contributed to the greater appeal and adaptation of study programmes to the job market.

During April, May and June 2021, the Faculty organised preparations for the higher level exam in mathematics for the national school-leaving examinations for all applicants who had opted to study at the Faculty of Engineering as their first or second choice. Preparations lasting 40 teaching hours were held by Faculty teachers in a virtual environment using a remote access platform.

An introductory lecture for first-year undergraduate university students, in which students starting their studies were given basic information about their studies, was held online at the end of September 2021. In the same week, introductory meetings of new students with study coordinators were held at the Faculty in small groups, adhering to the prescribed epidemiological measures.

In the last week of September, before the start of classes in the new academic year, as in previous years, preparatory seminars were held for new students in mathematics and programming, with the aim of revising certain content and preparing students for their studies. Preparatory seminars in 2021 were held remotely in an online environment.

Numerous research activities took place at the Faculty of Engineering during the 2020/2021 academic year, mostly within the framework of scientific projects. Research activities were conducted through projects carried out by the Faculty: 8 scientific projects funded by the Croatian Science Foundation, 6 EU projects, 4 COST projects, 3 ERASMUS+ projects, 3 IRI2 projects, 2 bilateral projects, and 2 research projects with the support of the business sector. The considerable number of UNIRI projects should be highlighted: 28 UNIRI projects, 2 with the support of UNIRI plus, 3 projects for young scientists, and 1 COVID project. In addition, our researchers participated in a number of scientific and research projects as part of teams organised by the University and other institutions. The results of research activities were disseminated at numerous conferences and through publication in journals, many of which are classified in the highest category. Through four conferences that we organised solely or in partnership with the Faculty, our scientists participated on the organisational and scientific committees of a number of scientific workshops. We are especially proud of the My First Conference for doctoral students, which was held this year at the Faculty of Maritime Studies and has an established international character. The conference showed once again the high



studenata i profesora u sklopu Erasmus+ programa. Studentima je omogućena mobilnost radi studijskog boravka i obavljanja stručne prakse, dok se mobilnost nastavnog i nenastavnog osoblja ostvaruje radi održavanja nastave i/ili stručnog usavršavanja.

Tehnički fakultet trenutno ima 32 sklopljena Erasmus+ bilateralnih ugovora sa Sveučilištima iz Austrije, Cipra, Češke, Finske, Francuske, Italije, Litve, Mađarske, Njemačke, Poljske, Portugala, Rumunjske, Slovenije, Srbije i Švedske.

Tijekom akademske godine 2020./2021., putem programa Erasmus+ mobilnosti, studenti Tehničkog fakulteta ostvarili su četiri studijske mobilnosti i jednu mobilnost radi obavljanje stručne prakse. Šest naših djelatnika realiziralo je odlaznu mobilnost zbog usavršavanja, a ugostili smo jednog profesora radi održavanja nastave i jednog radi usavršavanja.

Suradnja s gospodarstvom kao i s drugim znanstvenim i obrazovnim ustanovama iznimno je bitan segment djelatnosti Fakulteta. Stoga je i u akademskoj godini 2020./2021. nastavljeno s umrežavanjem i poticanjem zajedničkog rada na znanstvenim i stručnim projektima, a sklopljeno je i više ugovora i sporazuma o znanstvenoistraživačkoj, obrazovnoj i stručnoj suradnji.

quality, versatility and interdisciplinarity of the research of doctoral students at the Faculty of Engineering. Other than the presentation of their own research, our doctoral students were also part of the organising committee and conference co- chairs.

During the 2020/2021 academic year, the Faculty of Engineering continued contributing to the mobility of students and teaching staff within the framework of the Erasmus+ programme, providing mobility to students to study and complete their professional practice, while providing mobility to teaching and non-teaching staff for the purpose of teaching and professional development.

The Faculty of Engineering currently has 32 Erasmus+ bilateral agreements with universities from Austria, Cyprus, the Czech Republic, Finland, France, Italy, Lithuania, Hungary, Germany, Poland, Portugal, Romania, Slovenia, Serbia and Sweden.

In the 2020/2021 academic year, four of our students used the study mobility programme, while one used it for professional practice. Six of our teachers took advantage of the opportunity for professional development, while we hosted one foreign teacher who used the mobility programme to hold lectures and another for his professional development.

Collaboration with business, as well as other scientific and educational institutions, is an extremely important part of the Faculty's activities. Therefore, in the 2020/2021 academic year, the Faculty continued networking and encouraging cooperation on scientific and professional projects, and several contracts and agreements on scientific-research, and educational and professional cooperation were concluded.



## 2.2 STUDENTI NAGRAĐENI U AK. GODINI 2020./2021.

AWARDED STUDENTS IN THE 2020/2021 ACADEMIC YEAR

**NAGRADA ZA AKADEMSKI USPJEH** | AWARD FOR ACADEMIC ACHIEVEMENTS

**PREDDIPLOMSKI SVEUČILIŠNI STUDIJ** | UNDERGRADUATE UNIVERSITY STUDY

Studij / Study	Godina / Year	Ime i prezime / Name and surname	Postotak uspješnosti / Success rate		ECTS
			godine / year	studija / study	
Strojarstvo/ Mechanical Engineering	1.	Raul Ivan Gašljević	91%	91%	60
	2.	Laura Janković	90%	84%	120
Brodogradnja/ Naval Architecture	1.	Petra Lukačić	92%	92%	60
	2.	-			120
Elektrotehnika/ Electrical Engineering	1.	Mateo Buršić	85%	85%	60
	2.	Karlo Radošević	86%	85%	120
Računarstvo/ Computer Engineering	1.	Jakov Tomasić	94%	94%	60
	2.	Darijan Jelušić	90%	92%	120

**SVEUČILIŠNI PRVOSTUPNICI INŽENJERI** | UNIVERSITY BACHELOR ENGINEERS

Studij / Study	Ime i prezime / Name and surname	Postotak uspješnosti / Success rate
Strojarstvo/ Mechanical Engineering	Leona Petrc	90%
Brodogradnja/ Naval Architecture	-	
Elektrotehnika/ Electrical Engineering	Dean Krbavac	94%
Računarstvo/ Computer Engineering	Lucija Žužić	98%

**DIPLOMSKI SVEUČILIŠNI STUDIJ** | GRADUATE UNIVERSITY STUDY

Studij / Study	Godina / Year	Ime i prezime / Name and surname	Postotak uspješnosti / Success rate		ECTS
			godine / year	studija / study	
Strojarstvo/ Mechanical Engineering	1.	Alen Guštin	95%	95%	60
Brodogradnja/ Naval architecture	1.	Dora Vojnić	88%	88%	60
Elektrotehnika/ Electrical Engineering	1.	Tomo Galović	93%	93%	60
Računarstvo/ Computer Engineering	1.	Marina Banov	97%	97%	60

**MAGISTRI INŽENJERI** | MASTER ENGINEERS

Studij / Study	Ime i prezime / Name and surname	Postotak uspješnosti / Success rate
Strojarstvo/ Mechanical Engineering	Luka Lanča	95%
Brodogradnja/ Naval Architecture	Igor Knapić	85%
Elektrotehnika/ Electrical Engineering	Mateo Požgaj	94%
Računarstvo/ Computer Engineering	Mateja Napravnik	96%

**NAGRADA DEKANA ZA STUDENTSKI AKTIVIZAM**

| DEAN'S AWARD FOR STUDENT ACTIVISM

**MATEJ BERIŠA**

- Student 2. godine diplomskog sveučilišnog studija elektrotehnike / Student of the 2<sup>nd</sup> year of Graduate University Study of Electrical Engineering

**FILIP LIPOVAC**

- Student 2. godine diplomskog sveučilišnog studija računarstva / Student of the 2<sup>nd</sup> year of Graduate University Study of Computing

**TINA MLINARIĆ**

- Studentica 3. godine preddiplomskog sveučilišnog studija strojarstva / Student of the 3<sup>rd</sup> year of Undergraduate University Study of Mechanical Engineering



## 2.3 STUDENTSKI ZAVRŠNI I DIPLOMSKI RADOVI

### STUDENT UNDERGRADUATE AND GRADUATE THESES

IME I PREZIME | NAME AND SURNAME:

Marin Smilović

STUDIJSKI PROGRAM | STUDY PROGRAMME:

Diplomski sveučilišni studij brodogradnje

/ Graduate University Study of Naval Architecture

NAZIV RADA | TITLE:

Idejni projekt broda za sortiranje otpada s hrvatskih otoka

Preliminary design of a ship for waste sorting from the Croatian islands

MENTOR | SUPERVISOR:

prof. dr. sc. / Prof. D. Sc. Roko Dejhalla

Sažetak:

U 2018. godini na snagu su stupila nova EU pravila s pravno obvezujućim ciljevima za recikliranje otpada i smanjenje odlaganja otpada za koje države članice, a samim time i Republika Hrvatska (RH), moraju napraviti prilagodbu nacionalnog zakonodavstva za prelazak na kružno gospodarstvo. U Strategiji zaštite okoliša RH, gospodarenje otpadom je određeno kao nacionalni prioritet, a vizija je tzv. bezdeponijski koncept kojem se teži kao idealnom rješenju. Sukladno Planu gospodarenja otpadom, okosnica su reciklažna dvorišta, reciklažni centri sa sortirnicama i kompostištimama u kojima će se pripremati odvojeno prikupljeni otpad za recikliranje.

Koncept održivog razvitka ključna je odrednica razvoja Primorsko-goranske županije (PGŽ), a sukladno Strategiji gospodarenja otpadom RH, posebno je važna činjenica kako će na otocima u buduću biti onemogućeno trajno odlaganje otpada bilo koje vrste. Miješani komunalni otpad koji nastaje u PGŽ najprije se mora sortirati u lokalnoj pretovarnoj stanici na otoku, a zatim se cestovnim prijevozom odvesti u Županijski centar za gospodarenje otpadom što je, imajući u vidu otoke, skup i složen proces. S obzirom da je poznato da je pomorski prijevoz najjeftiniji, jedno bi od mogućih rješenja bilo da se na odgovarajućem brodu smjesti postrojenje za sortiranje i baliranje otpada. Brod bi pristajao na otocima, prikupljao otpad i zatim ga obrađivao. Time bi se izbjegla potreba postojanja sortirnice na svakom otoku što bi uvelike smanjilo potrebu za kamionskim prijevozom otpada s otoka.

U diplomskom je radu student razradio projektni zahtjev za idejni projekt broda za sortiranje otpada s hrvatskih otoka, uz poseban osvrt na velike otoke u PGŽ: Cres, Lošinj, Krk i Rab. Prema projektom zahtjevu izrađen je idejni projekt bro-

Summary:

In 2018, new EU rules came into force with legally binding targets for waste recycling and waste disposal. Member States, including the Republic of Croatia (RoC), must make adjustments to national legislation for the transition to a circular economy. In the Environmental Protection Strategy of the RoC, waste management is defined as a national priority, and the goal is the so-called landfill-free concept. The core elements of the Waste Management Plan are recycling yards, recycling centres with sorting plants, and composting plants, where separately collected waste will be prepared for recycling.

The concept of sustainable development is a key determinant in the development of Primorje-Gorski Kotar County (PGKC), and in accordance with the Waste Management Strategy of the RoC, a particularly important fact is that permanent disposal of waste of any kind will not be possible on the islands. Mixed municipal waste generated in PGKC first has to be sorted at a local trans-shipment station on the island, and then transported by road to the County Centre for Waste Management, which is an expensive and complex process. Given that maritime transport is known to be the cheapest means, one possible solution would be to place a waste sorting and baling plant on a suitable ship. The ship would dock at the islands, collect and then process the waste, which would avoid the need for each island to have its own sorting plant, and at the same time would greatly reduce the need for truck transport from islands.

In this diploma thesis, the student investigated the mission requirements for the conceptual design of a ship for sorting waste from Croatian islands, with special reference to the large islands of PGKC: Cres, Lošinj, Krk and Rab. Based

da s pripadajućim proračunima, općim planom i tehničkim opisom. Namjena broda bila bi sortiranje komunalnog otpada bez biološki razgradive komponente (biootpad) koja se prethodno mora odvojiti na otoku. Brod bi imao posebno postrojenje za sortiranje otpada, a osim sortiranja otpada imao bi i određene kapacitete za skladištenje i uređaje za manipuliranje izlaznim proizvodom sortirnice koji čine bale prešanog otpada: plastika, PET i MET ambalaža, papir, karton i RDF gorivo. Kao postrojenje za sortiranje otpada uzeto je rješenje hrvatske tvrtke Tehnix d.o.o. iz Donjeg Kraljevca. Tijekom izrade projekta broda, napravljen je jedan krug po tzv. projektnoj spirali, pri čemu su detaljno razmatrani sljedeći elementi: projektni zahtjev, glavne dimenzije broda, forma trupa broda, hidrostatičke značajke broda, raspored prostora, proračun strukture, proračun otpora i propulzije, procjena masa i težišta te proračun trima i stabiliteta broda u neoštećenom i oštećenom stanju. Također je napravljena energetska bilanca broda kako bi se mogli odabrati dizelski generatori koji bi pokretali propulzijske elektromotore kao i sve druge električne sustave na brodu, uključujući i sortirnicu.

Projekt je jedinstven jer u svijetu ne postoji sličan brod s postrojenjem za sortiranje i baliranje mješovitog komunalnog otpada.

on the requirements, a preliminary design of a ship was made with relevant naval architecture calculations, a general arrangement plan, and technical specifications. The purpose of the ship would be to sort municipal waste without a biodegradable component (biowaste) that must first be separated on the island. The ship would have a special plant for sorting waste and in addition would have certain storage capacities and devices for manipulating the output of the sorting plant, which consists of bales of pressed waste: plastic, PET and MET packaging, paper, cardboard and RDF fuel. The solution of the Croatian company Tehnix Ltd of Donji Kraljevec was taken for the waste sorting plant.

During the design phase, a round was made of the so-called design spiral. The following elements were considered in detail: mission requirements, main dimensions, lines and hull shape, hydrostatic characteristics, ship layout, structure calculation, resistance and propulsion, mass and centre of gravity estimate, trim and contact, as well as damaged stability. An energy balance of the ship was also made so that diesel generators could be selected to power the propulsion electric motors as well as all other electrical systems on the ship, including the sorting plant.

The design is unique because there is no similar ship in the world with a plant for sorting and baling mixed municipal waste.

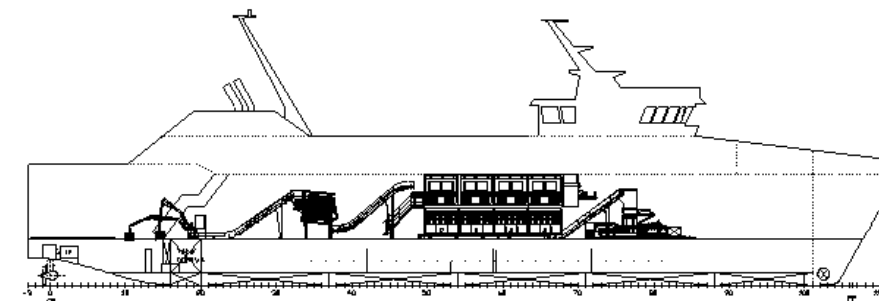

Opći plan broda – sortirnice otpada  
/ General arrangement plan of a ship for sorting waste

IME I PREZIME | NAME AND SURNAME:  
 Filip Pejčinović

STUDIJSKI PROGRAM | STUDY PROGRAMME:  
 Preddiplomski sveučilišni studij brodogradnje  
 / Undergraduate University Study of Naval Architecture

NAZIV RADA | TITLE:  
**Izrada tehnološke dokumentacije prema detaljnom modelu trupa broda**  
 Preparation of Tehnological Documentation According to the Detailed Model of the Ship Hull

MENTOR | SUPERVISOR:  
 izv. prof. dr. sc. / Prof. D. Sc. Marko Hadjina

Sadržaj:

Student je u radu je za odabranu sekciju broda izradio tehnološku dokumentaciju prema samostalno modeliranom klasifikacijskom i detaljnom modelu trupa broda. Opisana je potrebna dokumentacija za izradu broda kao i proces gradnje odabrane sekcije. Detaljno je opisano modeliranje i projektiranje 3D modela iste sekcije koja je modelirana u programu 3D Experience. Objasnjeni su svi postupci izrade tog modela, kao i radno sučelje u kojem je model rađen. Cijeli proces je prikazan i opisan te su u konačnici priloženi detaljni nacrti radioničke tehnološke dokumentacije izrađene prema standardima brodogradnje, usporedivi s nacrtima u stvarnom brodogradilištu i proizvodnji.

Summary:

In the paper, the student defined the technological documentation for the selected block of a ship according to an independently modelled classification and a detailed model of the ship's hull. The necessary documentation for the construction of the ship is described, as well as the process of building the selected block of the ship. The modelling and design of 3D models of the same section that is modelled in the 3D Experience programme is described in detail. All the procedures for making this model are explained, as well as the working interface in which the model was made. The whole process is shown and described, and detailed drafts of workshop technological documentation according to shipbuilding standards, comparable to drawings in an actual shipyard and production, are presented.

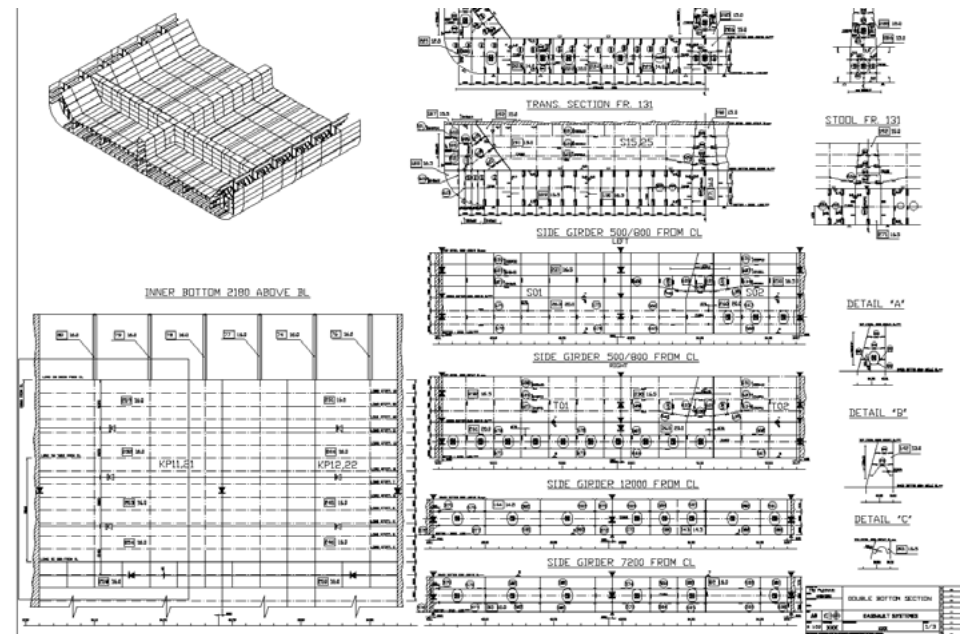

Radionička tehnološka dokumentacija dvodna broda  
 / Ship double bottom detailed production documentation

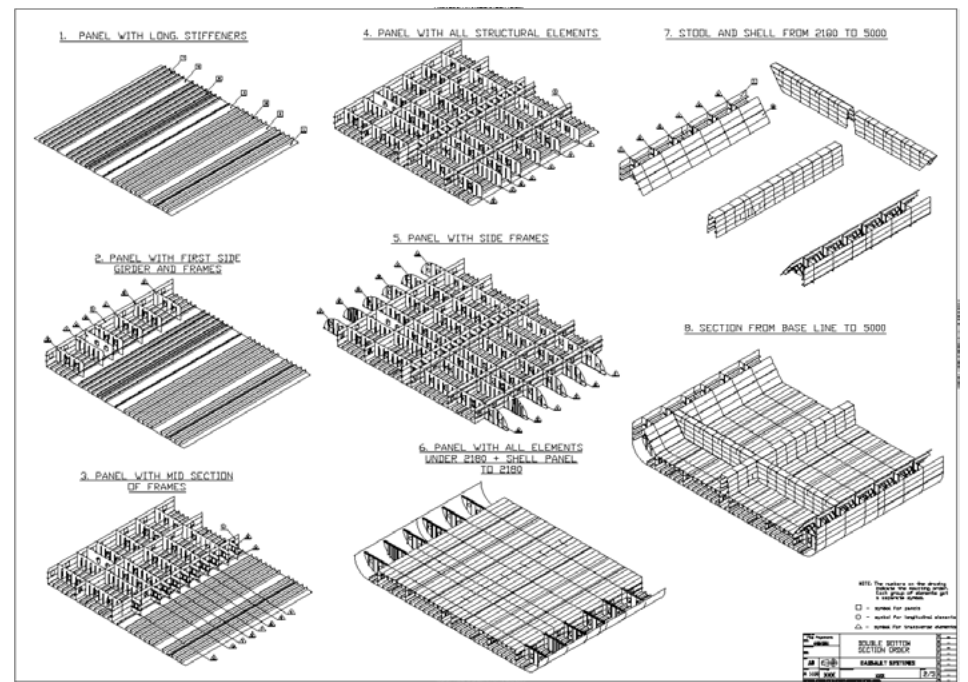

Tehnološka dokumentacija ukupnjavanja dvodna broda  
 / Ship double bottom assembly documentation

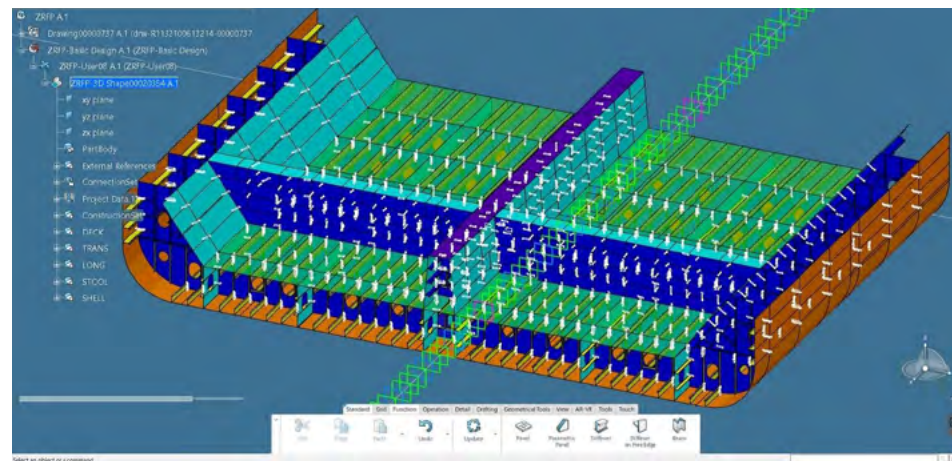

Model sekcije dvodna broda modeliran u 3D Experience  
 / Model of ship double bottom modelled in 3D Experience

IME I PREZIME | NAME AND SURNAME:

Leo Benolić

STUDIJSKI PROGRAM | STUDY PROGRAMME:

Diplomski sveučilišni studij elektrotehnike  
/ Graduate University Study of Electrical Engineering

NAZIV RADA | TITLE:

**Projektiranje autonomnog vozila**

Autonomous Vehicle Design

MENTOR | SUPERVISOR:

prof. dr. sc. / Prof. D. Sc. Zlatan Car

Sadržaj:

U diplomskom radu dan je prikaz izrade autonomnog vozila (električni romobil) s komunikacijom računala. Glavne komponente uz pogonske motore su ultrazvučni HC-SR04 senzor, MPU9250 IMU senzor, sustav stabilizacije masenim žiroskopom, Arduino Due i računalo s Matlab programom. Pomoću serijske komunikacije, s računala na kojem je korišten Matlab program, poslane su upute robotu koji se kreće po prostoru. Svojim kretanjem snimao je okolni prostor s osam ultrazvučnih senzora uz povratnu informaciju s enkodera kotača i pozicije upravljača. U Matlab programu izrađena je skripta s kojom se izračunava lokacija i usmjerenje robota prema dobivenim informacijama od enkodera i kuta upravljača. Nadalje, za dobivenu poziciju moguće je prikazati mapu s informacijama o senzorima. Za planiranje putanje i izbjegavanje prepreka korišteni su: dijekstra, modificirani dijekstra, ASTARPATH2SIDED algoritam i genetski algoritam.

Summary:

The work presented in this thesis is about an autonomous computer-controlled vehicle (Electric Scooter). The main components of the vehicle, in addition to the drive motors, include ultrasonic Sensors (HC – SR04), IMU sensors (MPU9250), a stabilisation system with a mass gyroscope, an Arduino duo control board and a personal computer (PC) with a control program based on MATLAB software. The robot moves around with instructions sent from the PC as serial communication from the MATLAB program. The robot can make a detailed map of the area of movement with the feedback from the wheel encoders and steering wheel positions and using data from eight ultrasonic sensors. Furthermore, the robot displays a map with all the information from these sensors. To plan a route and to avoid obstacles, the Dijkstra, modified Dijkstra and ASTARPATH2SIDED algorithm of MATLAB, along with genetic algorithms, are used.

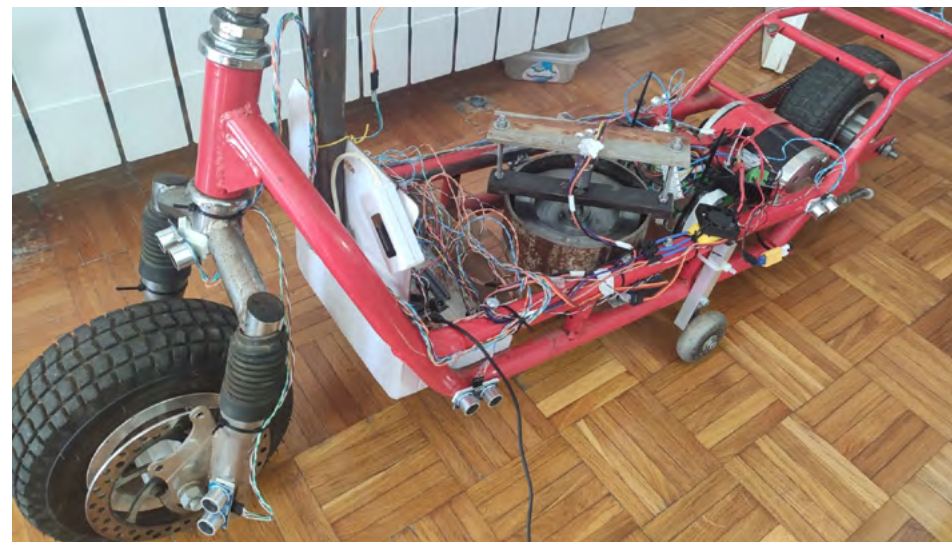

Autonomno vozilo (romobil)  
/ Autonomous vehicle (scooter)

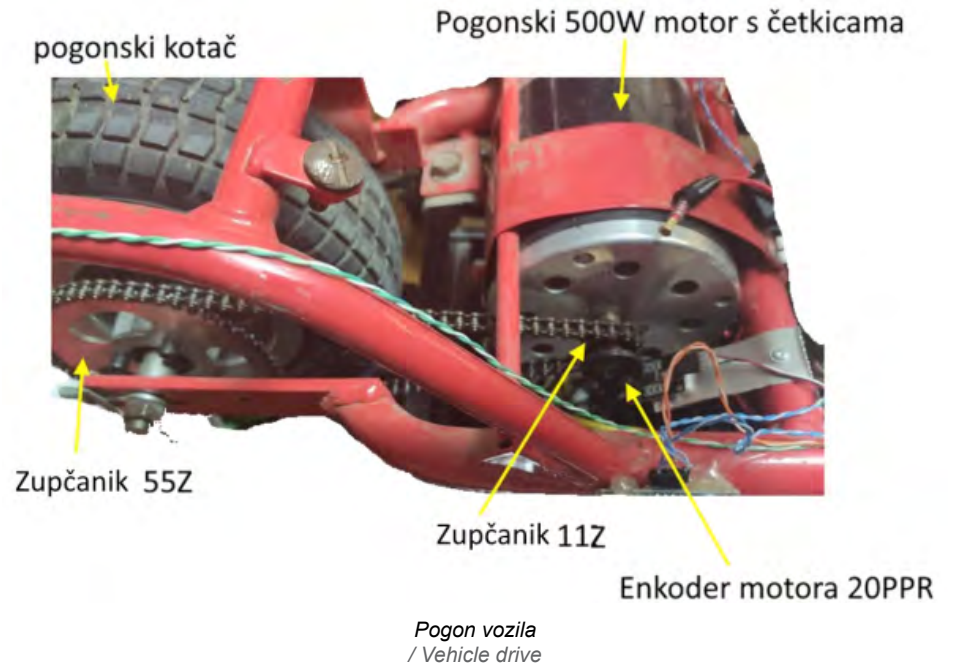

Pogon vozila  
/ Vehicle drive



Putanja dobivena korištenjem dijekstra algoritma  
/ Path obtained using Dijkstra algorithm

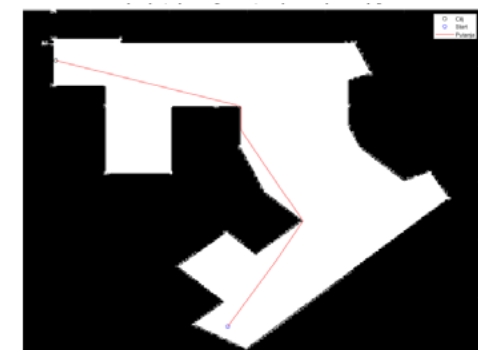

Putanja dobivena korištenjem A\* algoritma  
/ Path obtained using A\* algorithm



Putanja dobivena korištenjem genetskog algoritma  
/ Path obtained using genetic algorithm





IME I PREZIME | NAME AND SURNAME:

Mateo Cuculić

STUDIJSKI PROGRAM | STUDY PROGRAMME:

Diplomski sveučilišni studij elektrotehnike

/ Graduate University Study of Electrical Engineering

NAZIV RADA | TITLE:

**Predikcija kritične temperature supravodiča pomoću algoritama umjetne inteligencije**

Prediction of Supraconductor Critical Temperature Using Artificial Intelligence Algorithms

MENTOR | SUPERVISOR:

prof. dr. sc. / Prof. D. Sc. Zlatan Car

Sadržaj:

U ovom radu opisuje se primjena umjetnih neuronskih mreža, višeslojni perceptron (MLP) i genetskog programiranja (GP) za predviđanje kritične temperature supravodičkih materijala. Ukratko su opisani supravodiči i neka njihova svojstva. Zatim su opisane umjetne neuronske mreže, korelacijski koeficijenti i genetsko programiranje, zajedno s ostalim algoritmima i bazom podataka korištenih u sklopu rada. Na kraju je objašnjen programski kod, prikazani su dobiveni rezultati nekoliko različitih umjetnih neuronskih mreža i programa dobivenih primjenom genetskog programiranja. Programski kod pisan je u Python programskom jeziku uz pomoć Pandas, Numpy, Seaborn, Sklearn i Gplearn programskih knjižnica.

Korelacijska analiza rađena je prema Pearsonovom i Spearmanovom koeficijentu korelacije pomoću kojih su određene ulazne varijable s najvišim utjecajem na kritičnu temperaturu supravodiča. Modeli za predviđanje određeni MLP algoritmom pokazuju malu pogrešku, od +/- 6 [K], dok modeli određeni GP algoritmom pokazuju više grešaka. Podjelom seta podataka prema valenciji dobivaju se bolji rezultati, s minimalnom greškom od 2.7457 [K].

Summary:

This paper describes the application of artificial neural networks and genetic programming algorithms used for predicting the critical temperatures of superconducting materials. First, some basic properties of superconductors are briefly described. Artificial neural networks, the multilayer perceptron (MLP), correlation coefficients and genetic programming (GP), along with other machine learning algorithms and the database that is used in this paper are also described. Finally, the program code is explained and the obtained results of several different artificial neural networks and genetic programs are presented. The program code is written in the Python programming language with the help of pandas, Numpy, Seaborn, Sklearn and Gplearn programming libraries.

A correlation analysis is performed with Pearson and Spearman correlation coefficients, which were used to determine the input variables with the greatest influence on the critical supraconductor temperature. The models determined using the MLP algorithm show a small error, of +/- 6 [K], while the models determined using the GP algorithm show greater errors. Through the dataset division according to valence, better results are achieved, with the minimal error reaching 2.7457 [K].

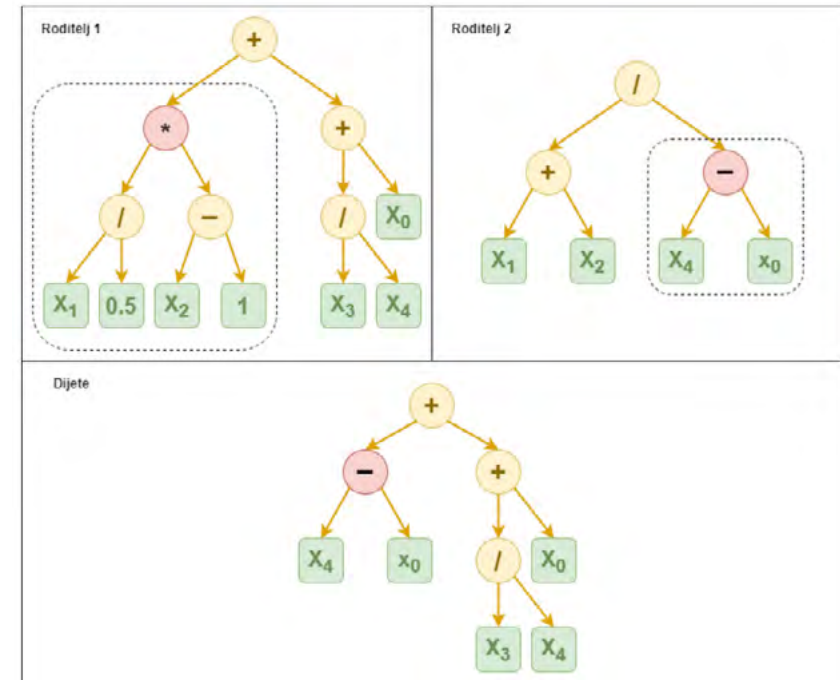

Ilustracija GP algoritma / Illustration of the GP algorithm

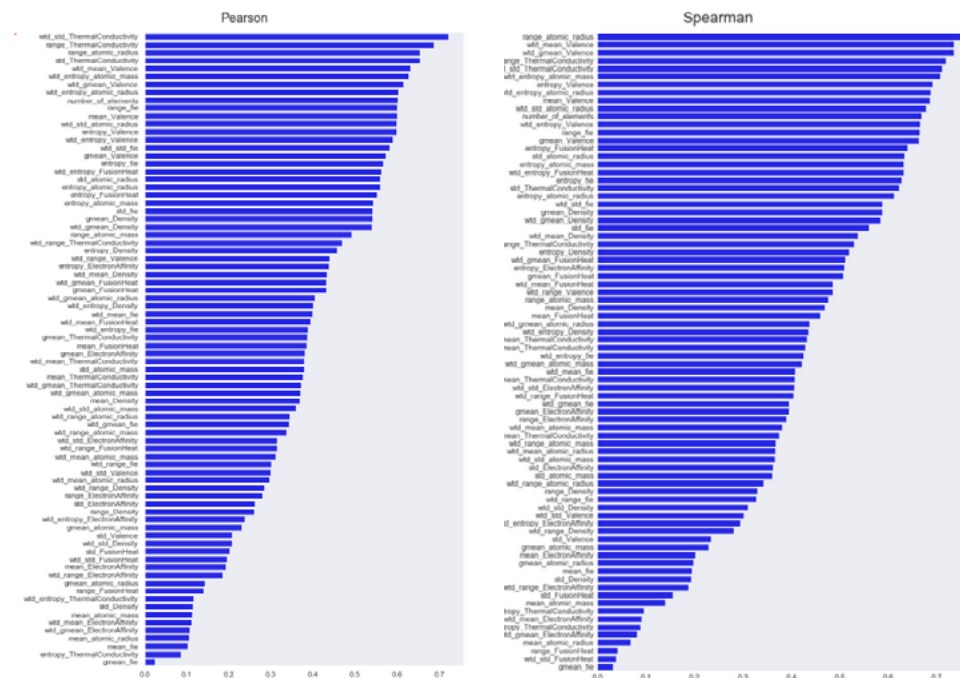

Određeni korelacijski koeficijenti između ulaznih varijabli i kritične temperature supravodiča / The determined correlation coefficients between the input variables and the supraconductor critical temperature



IME I PREZIME | NAME AND SURNAME:  
Edin Hodžić

STUDIJSKI PROGRAM | STUDY PROGRAMME:  
Preddiplomski stručni studij elektrotehnike  
/ Undergraduate University Study of Electrical Engineering

NAZIV RADA | TITLE:  
**Trofazni mosni izmjenjivač u praksi**  
Three-Phase Bridge Inverter Application

MENTOR | SUPERVISOR:  
izv. prof. dr. sc. / Assoc. Prof. D. Sc. Saša Sladić

**Sažetak:**

U radu su opisani djelovanje i komponente trofaznog mosnog izmjenjivača tako što je izmjenjivač simuliran s idealnim komponentama u programskom paketu „Plecs“, a dobiveni rezultati simulacije uspoređeni su s rezultatima mjerenja na komercijalnom pretvaraču. Simuliran je trofazni asinkroni stroj u motorskom načinu rada u neopterećenom i opterećenom stanju, a parametri simuliranog stroja su uzeti s električnog stroja tipa KZK90L8 snage 0.55 kW proizvođača „Sever“. Za usporedbu s rezultatima simulacije korišten je trofazni mosni izmjenjivač tipa EVAL-M1-IM828-A tvrtke Infineon s upravljačkim sklopom EVALM1101TTOBO2 istog proizvođača. Cilj rada bio je analizirati i simulirati rad trofaznog mosnog izmjenjivača u računalnom programu „Plecs“ te dobivene rezultate usporediti s komercijalnim rješenjem. U radu je utvrđeno da se pomoću računalnih simulacija s idealnim komponentama može djelotvorno prikazati rad sastavljenog modularnog sklopa.

Ključne riječi: trofazni mosni izmjenjivač; simulacija rada izmjenjivača; rad izmjenjivača.

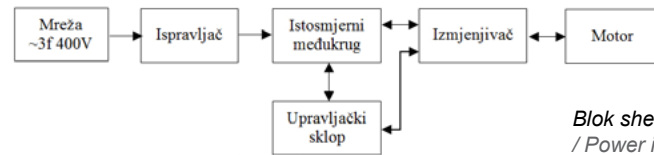

*Blok shema izmjenjivača  
/ Power inverter representation*

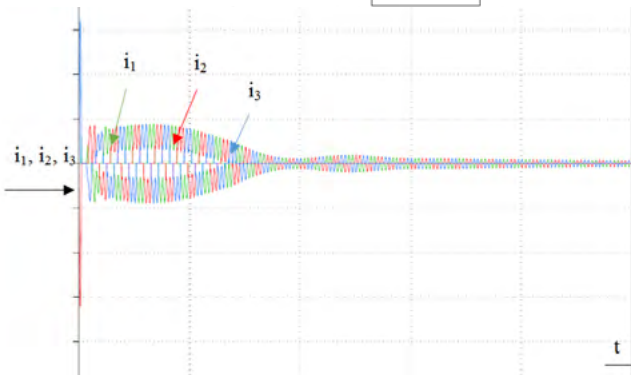

*Simulirani valni oblici ulazne struje pretvarača tijekom uključanja  
(20A/d.s., 100ms/d.s.)  
/ Simulated waveform of input current after start of power converter (20A/div., 100ms/div.)*

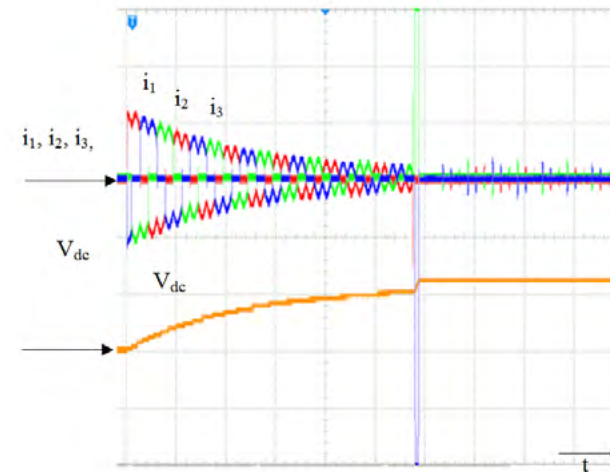

*Izmjereni valni oblici ulazne struje i napona VDC pretvarača tijekom uključanja  
(500V/d.s., 5A/d.s., 20ms/d.s.)  
/ Measured waveform of input current and VDC after start of power converter (500V/div., 5A/div., 20ms/div.)*

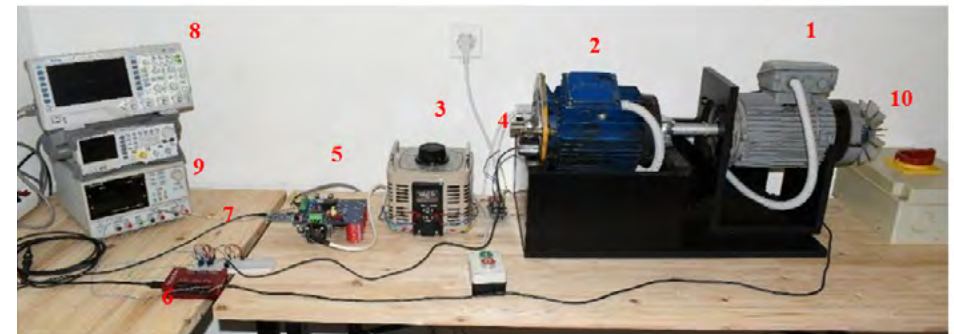

**Laboratorijski postav**  
/ Laboratory set-up

- |   |   |
|---|---|
| 1. asinkroni stroj<br>/ KZK90L8 Sever induction machine                           | 6. akvizicijski modul<br>/ Labjack U3 - HV acquisition module |
| 2. asinkroni stroj<br>/ 5AZK100LA-4 Končar induction machine                      | 7. operacijsko pojačalo<br>/ operational amplifier,           |
| 3. varijabilni transformator<br>/ 0-300V, 3kVa variable voltage power transformer | 8. osciloskop<br>/ oscilloscope,                              |
| 4. senzor pritiska<br>/ pressure sensor,  | 9. laboratorijsko napajanje<br>/ laboratory supply            |
| 5. trofazni mosni izmjenjivač<br>/ three-phase power inverter,                    | 10. senzor broja okretaja<br>/ rotational speed sensor        |

IME I PREZIME | NAME AND SURNAME:

Robert Lesjak

STUDIJSKI PROGRAM | STUDY PROGRAMME:

Preddiplomski stručni studij elektrotehnike

/ Undergraduate University Study of Electrical Engineering

NAZIV RADA | TITLE:

Automatizirana provjera baterija

Robotic Battery Testing

MENTOR | SUPERVISOR:

izv. prof. dr. sc. / Assoc. Prof. D. Sc. Saša Sladić

prof. dr. sc. / Prof. D. Sc. Zoran Jurković

Sažetak:

Sa sve većom primjenom litij-ionskih baterija javlja se potreba za recikliranjem ili produženjem njihovog životnog vijeka. Svaka primjena litij-ionskih baterija mora zadovoljiti specifične uvjete, a kada ih ne može više zadovoljiti, bateriju je potrebno zamijeniti. Stare baterije bi zatim bilo poželjno ponovno iskoristiti u nekom drugom uređaju za koji još uvijek imaju zadovoljavajuće karakteristike, te zatim vršiti recikliranje u osnovne elemente.

Ispitivanje ispravnosti i parametara starih litij-ionskih baterija vrši se tako da se baterija napuni do maksimalnog preporučenog napona, a zatim se isprazni do minimalnog preporučenog napona, čime se implicira kapacitet baterije. Taj kapacitet se zatim uspoređuje s kapacitetom nove baterije i zaključuje se u kojoj primjeni je tu bateriju moguće ponovo iskoristiti.

Za mjerenje kapaciteta izrađeno je istosmjerno trošilo kojim se može upravljati računalnom serijskom komunikacijom. Linearnim regulatorom sklopa upravlja STM32L0 mikrokontroler za koji je programski kod pisan u jeziku C. Razvojno okruženje optimizirano za STM32 mikrokontrolere je STM32CubeIDE u kojem se nalazi fleksibilan alat CubeMX za konfiguraciju perifernih jedinica, brojila, ulaza i izlaza mikrokontrolera. Ovaj alat omogućuje brzi razvoj programskog koda jer je fokus na logici koju mikrokontroler vrši, dok je konfiguracija mikrokontrolera automatski generirana na bazi odabranih parametara u CubeMX alatu (eng. rapid prototyping).

Kako se radi o velikom broju baterija koje je potrebno karakterizirati, a proces se sastoji od poslova i za čovjeka i za robota, moguće je koristiti kolaborativnog robota. Takva je primjena opravdana za izvedbu opetovanih manipulacija na istome radnome mjestu te je korišten robot Yaskawa HC10. Riječ je o sofisticiranoj opremi koja je odnedavno prisutna na Tehničkom fakultetu Sveučilišta u Rijeci.

Summary:

Lithium-ion batteries are becoming very popular in the industry, and thus the need to recycle or repurpose them grows. All applications of lithium-ion batteries have specific needs that the battery needs to meet. When the battery does not meet those needs anymore, it is replaced with new ones and old batteries can then be reused somewhere else before they are recycled for raw materials.

The testing of such batteries is done by first charging them to the maximum recommended voltage, then discharging them to the lowest recommended voltage, while in the process measuring the total capacity of the battery. The recorded capacity is then compared to the original capacity of the battery. After characterisation, the battery can be discarded or reused in some other application.

To measure the capacity of lithium-ion batteries, a fully controllable DC load was made using a linear regulator and microcontroller. To control the linear regulator, an STM32L0 microcontroller was used, the code for which was written in the C programming language. The integrated development environment or IDE used for the development of the software for the STM32 microcontrollers is STM32CubeIDE, with its flexible tool CubeMX, which enables a user-friendly initialisation of peripheral units, timers, clocks, inputs, and outputs. This tool makes development faster (rapid prototyping), because it provides the ability to focus on the logic that the code must perform rather than using additional time configuring the parameters.

Since there is a large number of lithium-ion batteries to be repurposed and the work can't be fully automated, it is practical to use collaborative robots to automate certain tasks. The Yaskawa HC10 has been used in order to prepare batteries for measurement. This sophisticated equipment has recently arrived at the Faculty of Engineering of the University of Rijeka.

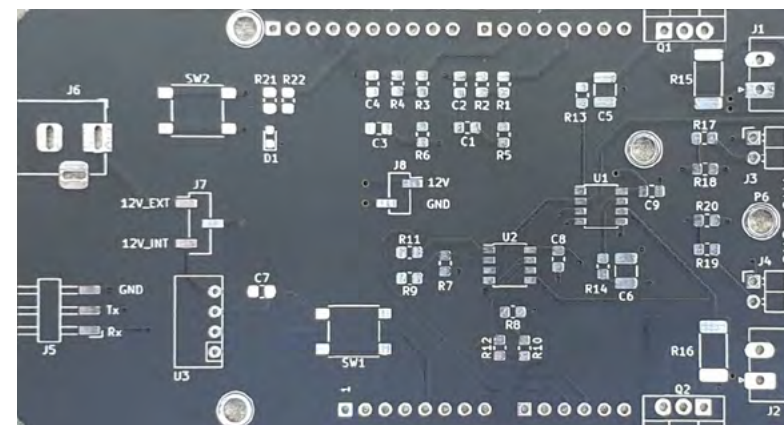

Tiskana pločica istosmjernog trošila koja se spaja na NUCLEO-64 razvojnu pločicu  
/ Printed circuit board of the DC load as a shield for the NUCLEO-64 development board



Istosmjerno trošilo smješteno u 3D ispisano kućište  
/ DC load electronics housed in a 3D printed housing



3D ispisana hvataljka za 18650 litij-ionske baterije montirana na robotskoj ruci YASKAWA HC10DT  
/ 3D printed gripper for 18650 lithium-ion batteries mounted on a YASKAWA HC10DT robotic arm



Postavljanje litij-ionske baterije na stanicu za mjerenje robotskom rukom  
/ Placing lithium-ion battery on a discharging station using a robotic arm

IME I PREZIME | NAME AND SURNAME:

Nardi Verbanac

STUDIJSKI PROGRAM | STUDY PROGRAMME:

Diplomski sveučilišni studij elektrotehnike

/ Graduate University Study of Electrical Engineering

NAZIV RADA | TITLE:

**Simulacijski model sustava vektorskog upravljanja sinkronim strojem napajanog iz ciklopretvarača**

A Simulation Model of a Field-Oriented Control System for a Cycloconverter-Powered Synchronous Machine

MENTOR | SUPERVISOR:

izv. prof. dr. sc. / Assoc. Prof. D. Sc. Neven Bulić

Sadržaj:

Sinkrone strojeve s električnom uzбудom uglavnom se vezuje uz proizvodnju električne energije. Međutim, sinkroni strojevi s električnom uzбудom sve se češće koriste u elektromotornim pogonima promjenjive brzine, a posebno u pogonima velikih snaga gdje do izražaja dolaze njihove prednosti u odnosu na ostale strojeve. Naime, osnovne prednosti sinkronih strojeva u odnosu na asinkrone, ali i druge vrste strojeva, svakako su visoka korisnost (i do 97 % kod velikih sinkronih strojeva) i mogućnost upravljanja jalovom snagom čime je moguće znatno ispraviti faktor snage, a time i smanjiti neželjene gubitke i troškove u industrijskim sustavima s mnoštvom induktivnih trošila. Pritom, iznimne je performanse sinkronog stroja moguće postići primjenom takozvanog vektorskog upravljanja.

Ovaj diplomski rad nastao je kao rezultat suradnje Tehničkog fakulteta i tvrtke Danieli Automation S.p.A. na razvoju naprednih upravljačkih struktura za elektromotorne pogone. Težište ovog diplomskog rada stavljeno je na razvoj sustava vektorskog upravljanja sinkronog stroja s električnom uzбудom namijenjenog napajanju iz ciklopretvarača. Shodno tome, nakon uvodnih razmatranja danih u prvom poglavlju, u drugom je poglavlju rada dan pregled teorije koordinatnih sustava na temelju koje je nadalje izveden dvoosni (dq) model sinkronog stroja iz kojeg proizlazi vektorski dijagram stroja. U trećem poglavlju ukratko je opisan način rada ciklopretvarača. Četvrto poglavlje posvećeno je razvoju sustava vektorskog upravljanja sinkronim strojem koji se temelji na vektorskom dijagramu stroja, pripadna struktura upravljanja, kao i metode za estimaciju magnetskog toka u čijoj orijentaciji se vrši upravljanje. Budući da je razvijena struktura vektorskog upravljanja višepetljasta, opisan je proces određivanja optimalnih parametara regulatora. Ispravnost razvijenog sustava vektorskog upravljanja ispitana je na simulacijskom modelu istog

Summary:

Electrically excited or wound rotor synchronous machines are mainly associated with power generation. However, electrically excited synchronous machines are being increasingly used in variable speed drives, especially in high-power drives, where their advantages over other machines come to the fore. Namely, the main advantages of synchronous machines over induction, but also other types of machine, are certainly high efficiency (up to 97% in large synchronous machines) and their reactive power control capability with which they are able to significantly correct the power factor and thus reduce unwanted losses and costs in industrial power systems with a multitude of inductive loads. At the same time, high-performance responses of a synchronous machine can be achieved by applying a so-called vector control.

This master's thesis was written as a result of cooperation between the Faculty of Engineering and Danieli Automation S.p.A. on the development of advanced control structures for electric drives. The aim of this master's thesis was the development of a vector control structure for an electrically excited synchronous machine originally intended to be fed from a cycloconverter. Therefore, in Chapter Two of this thesis, an overview of the reference frame theory is given, based on which a two-reaction (dq) model of a synchronous machine is derived. Chapter Three briefly describes the operating principles of a cycloconverter. Chapter Four is dedicated to the development of a vector control structure for a synchronous machine. This chapter describes the principle of vector control of a synchronous machine based on the machine's space vector diagram, the associated control structure, as well as the usual methods for estimating the flux used for orientation. Since the developed control structure is a multi-loop one, the process of determining the optimal

opisanog u petom poglavlju, a pripadni rezultati prikazani su u šestom poglavlju. U sedmom poglavlju opisan je izrađeni simulacijski model ciklopretvarača i pripadnog mu upravljanja. Rezultati simulacije rada ciklopretvarača prikazani su u osmom poglavlju. Zaključna razmatranja iznesena su u posljednjem, devetom poglavlju.

parameters of the controllers is shown. The performance of the developed vector control structure has been tested on a simulation model built in PLECS. The obtained simulation results are presented in Chapter Six. In Chapter Seven, a simulation model of the three-phase cycloconverter and its associated control is described. The results regarding the simulation of the cycloconverter operation are presented in Chapter Eight. Finally, concluding remarks are made in the ninth and last chapter.

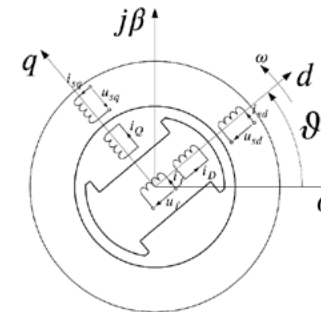

Presjek sinkronog stroja s ekvivalentnim namotima u uzdužnoj i poprečnoj osi / Cross-section of a synchronous machine with equivalent windings in the direct and quadrature axis

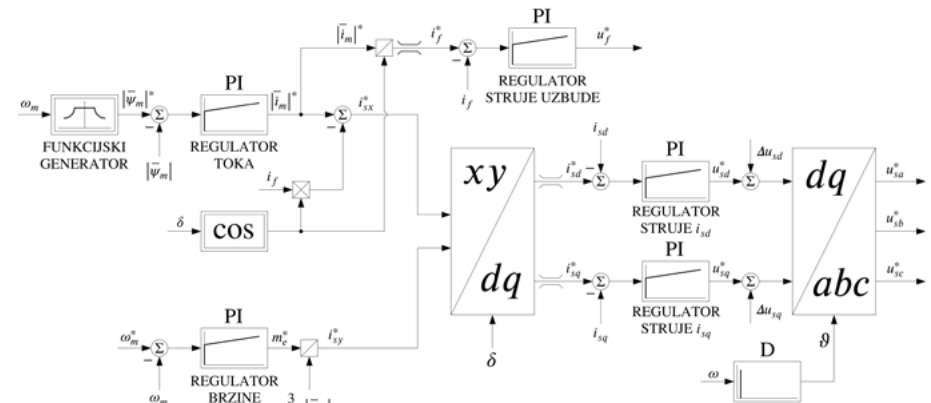

Razvijena struktura vektorskog upravljanja sinkronim strojem s električnom uzбудom / Developed vector control structure of an electrically excited synchronous machine

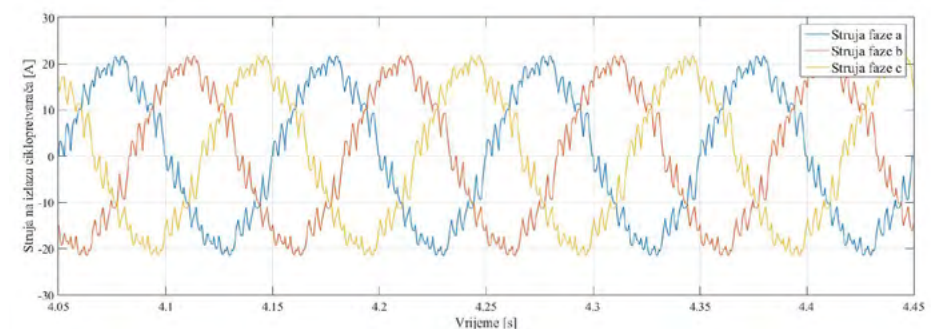

Valni oblik struje na izlazu ciklopretvarača / Waveform of the cycloconverter output current



IME I PREZIME | NAME AND SURNAME:

Stella Dumenčić

STUDIJSKI PROGRAM | STUDY PROGRAMME:

Preddiplomski sveučilišni studij računarstva

/ Undergraduate University Study of Computer Engineering

NAZIV RADA | TITLE:

Razdvajanje rendgenskih slika s višestrukim projekcijama ili studijama

Separating X-Ray Images Containing Multiple Projections or Studies

MENTOR | SUPERVISOR:

izv. prof. dr. sc. / Assoc. Prof. D. Sc. Ivan Štajduhar

Sažetak:

Summary:

U ovom radu predložen je algoritam za razdvajanje slika (ISA) temeljen na osnovnim operacijama obrade slike u svrhu razdvajanja rendgenskih slika koje u sebi sadrže slike više projekcija ili studija u zasebne slike projekcija ili studija. Predloženi algoritam uspoređen je s YOLOv4 algoritmom temeljenom na dubokom učenju s metrikama preciznosti, brzine i zauzeća memorije. Pristup dubokog učenja ostvario je bolje rezultate za metrike preciznosti i brzine, dok je ISA algoritam imao manje zauzeće memorije.

In this thesis, an image separation algorithm (ISA) based on basic image processing operations is proposed for the purpose of separating X-ray images containing images of multiple projections or studies into separate images. The proposed algorithm was compared with the Deep Learning based YOLOv4 algorithm using precision, speed and memory usage metrics. The Deep Learning approach performed better on the metrics of precision and speed, while the ISA algorithm had less memory usage.

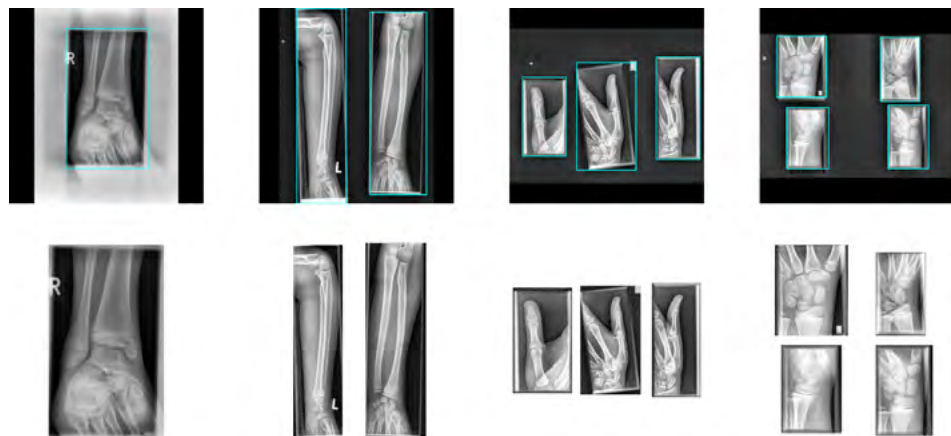

Ulazni podaci i očekivani izlaz  
/ Input images and expected output

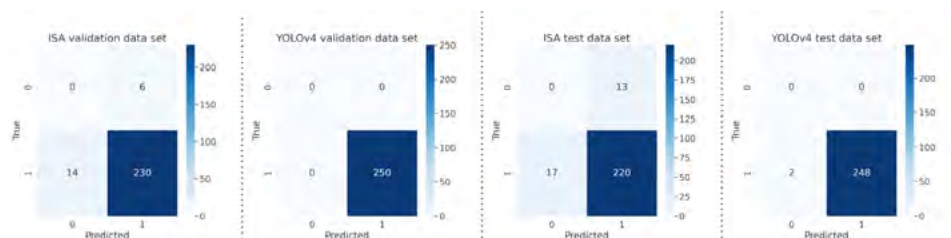

Matrice zabune ISA i YOLOv4 algoritma na validacijskom i testnom skupu  
/ Confusion matrices for ISA and YOLOv4 for validation and test set

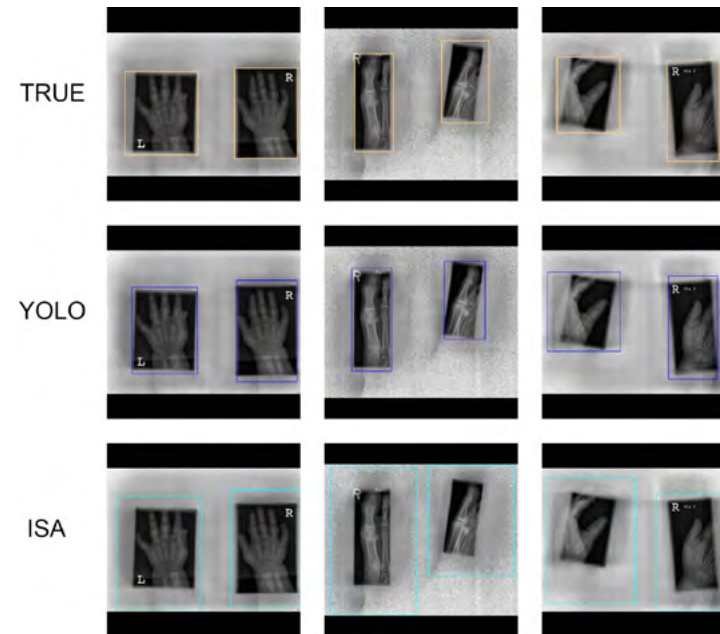

Primjeri uspješne segmentacije  
/ Examples of successful segmentation

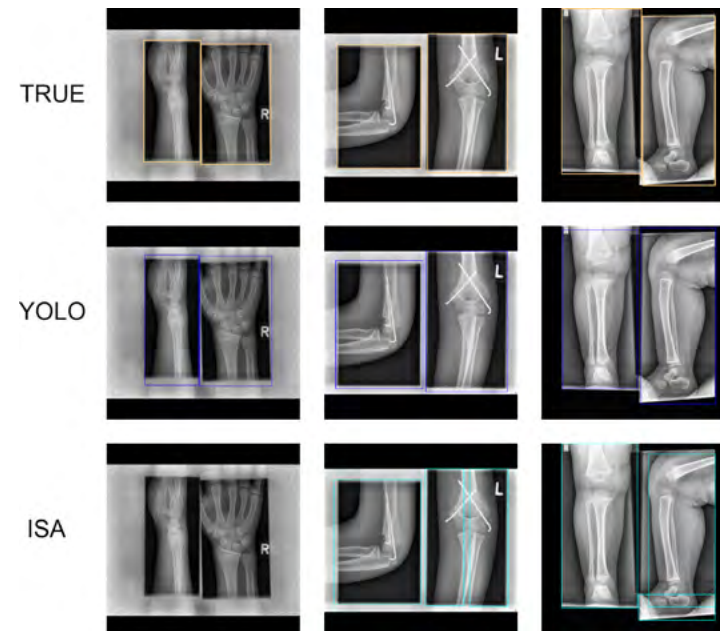

Primjeri neuspješne segmentacije ISA algoritma  
/ Examples of unsuccessful segmentation using ISA

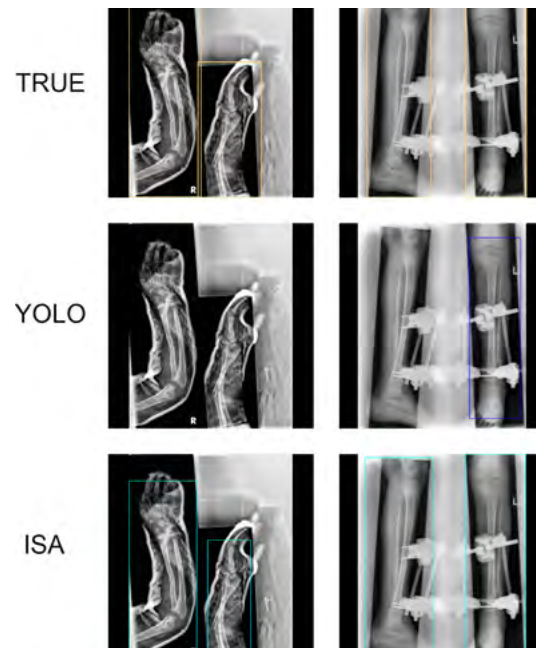

Primjeri neuspješne segmentacije YOLOv4 algoritma  
/ Examples of unsuccessful segmentation using YOLOv4

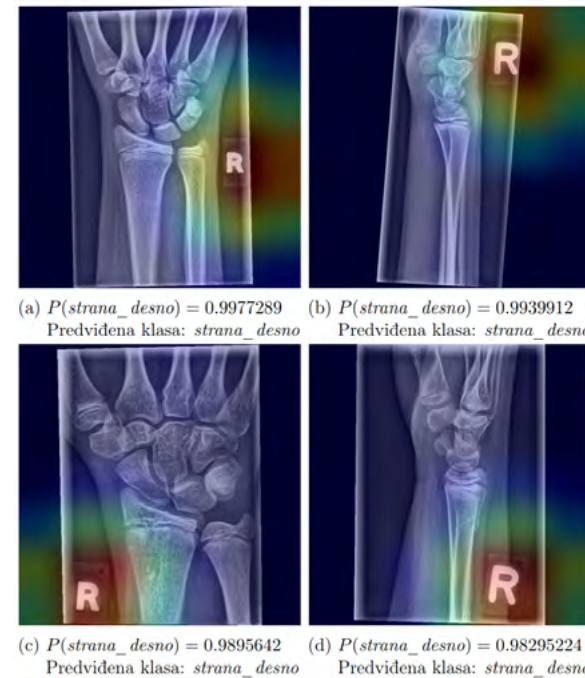

Primjer vizualnog objašnjenja odluke modela. Područja označena crvenom bojom su ona koje je model smatrao važnim pri donošenju svoje odluke. U ovom slučaju, model je naučio raspoznati stranu ruke na temelju oznake na slici.

/ An example of a visual explanation of a model decision. Areas marked in red are those that the model considered important in making its decision. In this case, the model learned to recognise the side of the hand based on the mark in the image

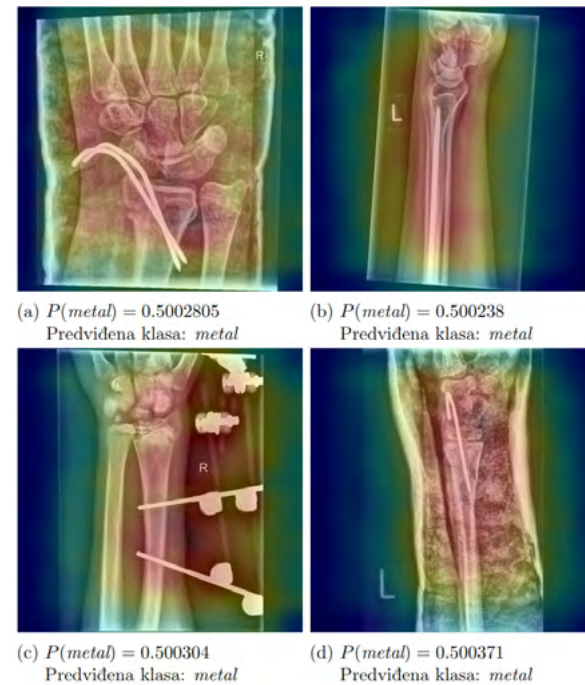

VGG-19 model treniran za prepoznavanje metalnih ugradnji na ruci, iako nije polučio dobre rezultate (točnost od oko 50%), dobivene Grad-CAM toplinske karte pokazuju kako se model ipak donekle koncentrirao na relevantna područja pri donošenju odluka

/ VGG-19 model trained to recognise metal implants in hands. Although it did not achieve good results (an accuracy of about 50%), the obtained Grad-CAM heat maps nonetheless show how the model still concentrated to some extent on relevant areas in its decision-making



IME I PREZIME | NAME AND SURNAME:

Karlo Filipčić

42

STUDIJSKI PROGRAM | STUDY PROGRAMME:

Diplomski sveučilišni studij računarstva

/ Graduate University Study of Computer Engineering

NAZIV RADA | TITLE:

Interpretabilnost konvolucijskih neuronskih mreža nad klasifikacijskim problemima iz rendgenskih slika pomoću grad-cam metode

Interpretability of Convolutional Neural Networks Over Classification Problems on X-Ray Images Using The Grad-Cam Method

MENTOR | SUPERVISOR:

izv. prof. dr. sc. / Assoc. Prof. D. Sc. Ivan Štajduhar

Sažetak:

Ovaj diplomski rad daje pregled korištenja Grad-CAM metode interpretabilnosti konvolucijskih neuronskih mreža nad klasifikacijskim problemima iz rendgenskih slika ruke. U tu svrhu su trenirani modeli različitih arhitektura na kojima je primijenjena Grad-CAM metoda interpretabilnosti. Pojedini rezultati su pokazali kako interpretabilnost izlaza modela eventualno može biti korisna radiolozima pri radu s rendgenskim slikama te potencijalno mogu poslužiti kao alat za postizanje većeg povjerenja ljudi u modele strojnog učenja.

Summary:

This thesis provides an overview of the use of the Grad-CAM method of interpretability of convolutional neural networks for classification problems from X-ray images. For this purpose, models of different architectures were trained, and the GradCAM interpretability method was applied to them. Some of the achieved results have shown that the interpretable output of models can provide radiologists with helpful assistance when working with X-ray images and could potentially serve as a tool to achieve greater trust from people in machine learning models.



43

IME I PREZIME | NAME AND SURNAME:

Boris Gašparović

STUDIJSKI PROGRAM | STUDY PROGRAMME:

Diplomski sveučilišni studij računarstva

/ Graduate University Study of Computer Engineering

NAZIV RADA | TITLE:

**Ekstrakcija prometnica iz satelitskih slika**

Road Extraction From Satellite Images

MENTOR | SUPERVISOR:

doc. dr. sc. / Assist. Prof. D. Sc. Jonatan Lerga

Sažetak:

U ovom radu prikazane su i uspoređene metode ekstrakcije prometnica iz satelitske snimke. Ukupno su uspoređena četiri modela ekstrakcije ceste iz satelitske snimke: dva open source modela koji se temelje samo na grafičkim značajkama, model predložen u ovom radu, pod nazivom modificirani algoritam, temeljen na grafičkim značajkama, i pristup ekstrakciji prometnica strojnim učenjem. Dokazali smo da je predloženi pristup modificiranim algoritmom uspješni od modela koji se temelje samo na grafičkim značajkama. Zaključeno je da smo korištenjem optimizacijskih metoda nad modelom koji koristi strojno učenje u mogućnosti bolje ekstrahirati ceste iz satelitskih snimaka, u usporedbi s metodom koja koristi modificirani algoritam.

Summary:

This thesis presents and compares methods for road extraction from satellite imagery. A total of four road extraction models from satellite images were compared: two open-source models based only on graphical features, the model proposed in this paper called a modified algorithm (also based on graphical features), and a model for extracting roads based on machine learning. We demonstrated that the proposed modified algorithm is the most successful method among those based only on graphical features. We concluded that by using optimisation methods over a model based on machine learning, we could better extract roads from satellite images compared to the method that uses a modified algorithm.



Usporedba metoda koje se temelje na grafičkim značajkama (slika u trećem stupcu je rezultat korištenja predloženog modificiranog algoritma)  
/ A comparison of methods based on graphical features (the image in the third column is the result of using the proposed modified algorithm)



Usporedba rezultata ekstrakcije modificiranim algoritmom i pristupa ekstrakciji strojnim učenjem  
/ A comparison of extraction results (modified algorithm and machine learning)

IME I PREZIME | NAME AND SURNAME:

Mateja Napravnik

STUDIJSKI PROGRAM | STUDY PROGRAMME:

Diplomski sveučilišni studij računarstva

/ Graduate University Study of Computer Engineering

NAZIV RADA | TITLE:

**Model prediktivnog vrednovanja učinkovitosti crtanja krivulja pokaznom napravom**

A Model for the Predictive Evaluation of the Efficiency of a Curve Drawing With a Pointing Device

MENTOR | SUPERVISOR:

doc. dr. sc. / Assist. Prof. D. Sc. Sandi Ljubić

Sažetak:

U području interakcije čovjeka i računala (HCI), pored akcije pokazivanja-i-odabira, često se formaliziraju i zadaci koji uključuju izvođenje neke zakrivljene trajektorije pokaznom napravom, odnosno usmjeravanje pokazivača odgovarajućim tunelom. Uz motivacijsko uporište u Fittsovom zakonu, a s obzirom na specifičnosti zadatka crtanja krivulja, u radu je predložen i adekvatno argumentiran model za izračun težine zadatka i procjenu vremena potrebnog za izvršavanje takvog zadatka. Dodatno, formalizirana je točnost izvođenja zadatka putem odgovarajuće metrike pogreške, kao i propusnost pokazne naprave u zadanom kontekstu. Predloženi model, u konačnici, u obzir uzima duljinu zadane trajektorije, širinu odgovarajućeg tunela, te zakrivljenost krivulje. Na temelju teorijskih osnova predloženog prediktivnog modela, dizajniran je i proveden HCI eksperiment s ciljem izlučivanja konkretnih inačica modela i metrika propusnosti za dvije različite pokazne naprave – miša i grafički tablet.

Provedena je i odgovarajuća provjera valjanosti modela, također zasnovana na eksperimentalnim zadacima sa stvarnim korisnicima. Pokazano je kako predloženi model predviđa vrijeme izvođenja zakrivljene trajektorije uz metriku pogreške RMSPE s najvećom vrijednošću 10.6 %. Eksperimentalni zadaci uključivali su krivu-

Summary:

In the field of Human-Computer Interaction (HCI), in addition to point-and-select actions, steering tasks are often formalised. These include performing a curved trajectory with a pointing device, i.e. steering the pointer through a corresponding tunnel. Along with the motivational basis in Fitts' Law, and given the specifics of the curve drawing task, this thesis proposes and argues a model for calculating the index of difficulty of the task and estimating the time required to perform it. Additionally, the accuracy of the task performance is formalised through the appropriate error metric, as well as the throughput of the pointing device in the given context. The proposed model ultimately takes into account the length of the given trajectory, the width of the corresponding tunnel, and the curvature of the curve. Based on the theoretical foundations of the proposed predictive model, an HCI experiment was designed and conducted in order to extract specific versions of the model and throughput metrics for two different pointing devices: a mouse and a graphics tablet.

Appropriate validation of the model was carried out, also based on experimental tasks with real users. It is shown that the proposed model predicts the curve drawing time with an RMSPE error metric with a maximum value of

lje različitih složenosti, pri čemu je neke od njih bilo lakše analitički formalizirati u Kartezijevom sustavu, a neke u polarnom sustavu. Jedna od glavnih odlika modela je upravo invarijantnost u odnosu na izabrani koordinatni sustav; drugim riječima – indeks težine zadatka ne ovisi o koordinatnom sustavu u kojem se krivulja vizualizira.

10.61%. The experiment tasks involved curves of varying complexity, some of which were easier to analytically formalise in the Cartesian system and others in the polar system. One of the main features of the proposed model is precisely the invariance – with respect to the chosen coordinate system. In other words, the index of difficulty of the task does not depend on the coordinate system in which the curve is visualised.

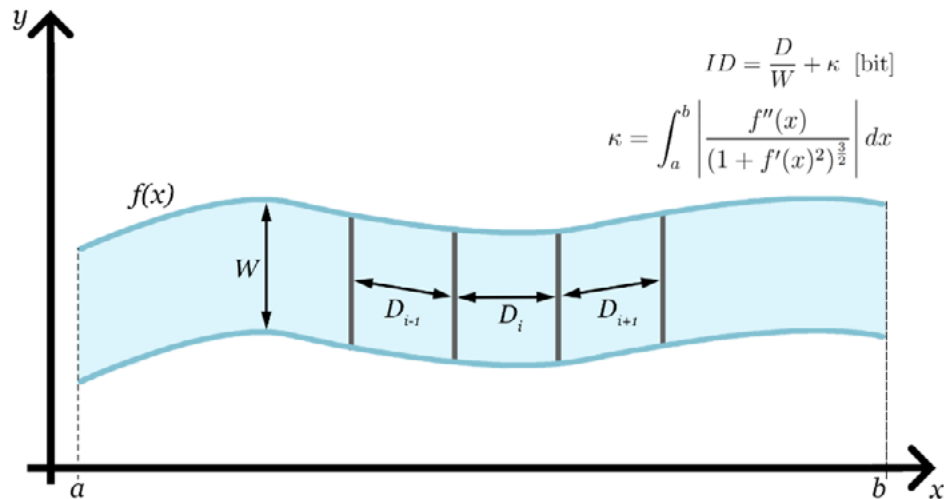

Predloženi model / The proposed model

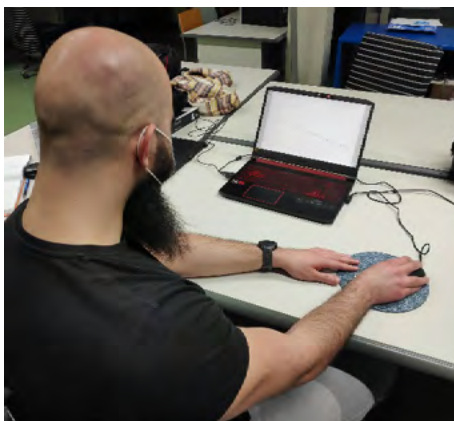

Sudionik u HCI eksperimentu / A participant in the HCI experiment

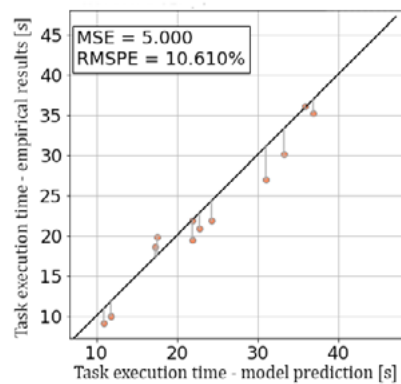

Provjera valjanosti modela / Model validation

IME I PREZIME | NAME AND SURNAME:

Bruno Bojković

STUDIJSKI PROGRAM | STUDY PROGRAMME:

Diplomski sveučilišni studij strojarstva

/ Graduate University Study of Mechanical Engineering

NAZIV RADA | TITLE:

Simulacija potrošnje goriva osobnog vozila s alternativnim pogonom

Simulation of an Alternative-Drive Car Fuel Consumption

MENTORI | SUPERVISORS:

prof. dr. sc./ Prof. D. Sc. Tomislav Mrakovčić

izv. prof. dr. sc. / Assoc. Prof. D. Sc. Tomislav Senčić

Sažetak:

Summary:

S ciljem smanjenja potrošnje goriva i emisija stakleničkih plinova u okoliš, razvijena su različita rješenja za pogon osobnog vozila. U ovom radu dan je tehnički opis mogućih rješenja alternativnih pogona osobnog vozila i navedene su prednosti i nedostatci svakog od njih. Pomoću računalne aplikacije ADVISOR provedena je simulacija potrošnje goriva i emisija za osobno vozilo na alternativni pogon na proizvoljno odabranoj relaciji. Simulacija je izvršena za nekoliko odabranih varijanti alternativnog pogona i izvršena je usporedba s klasičnim pogonom s motorom s unutrašnjim izgaranjem. Mjerenje parametara vozila s konvencionalnim pogonom odrađeno je na relaciji Rijeka – Zagreb. Tijekom putovanja pratilo se i mjerilo nekoliko parametara od kojih su, za potrebe ovog rada, najvažniji oni vezani za potrošnju goriva. Putovanje i mjerenje ukupno je trajalo 2 sata i 6 minuta, a u tom je vremenu prijeđena udaljenost od 181 kilometar. Vozilo kojem je vožena ruta je Ford Focus 1,6 TDCI, proizveden 2005. godine.

With the aim of reducing fuel consumption and greenhouse gas emissions into the environment, various solutions for the propulsion of passenger cars have been developed. This paper gives a technical description of possible solutions for alternative propulsion of a personal vehicle, listing the advantages and disadvantages of each. Using ADVISOR computer applications, a simulation of fuel consumption and emissions for an alternatively powered passenger car was performed on an arbitrarily selected route. The simulation was performed for several selected variants of alternative propulsion and a comparison was performed with conventional propulsion with an internal combustion engine. Measurement of the parameters of vehicles with conventional drivetrains was performed on the Rijeka-Zagreb route. During the trip, several parameters were monitored and measured, the most important of which were those related to fuel consumption. The journey and measurement lasted a total of 2 hours and 6 minutes, during which time a distance of 181 kilometres was covered. The vehicle on which the route was driven is a 2005 Ford Focus 1.6 TDCI.

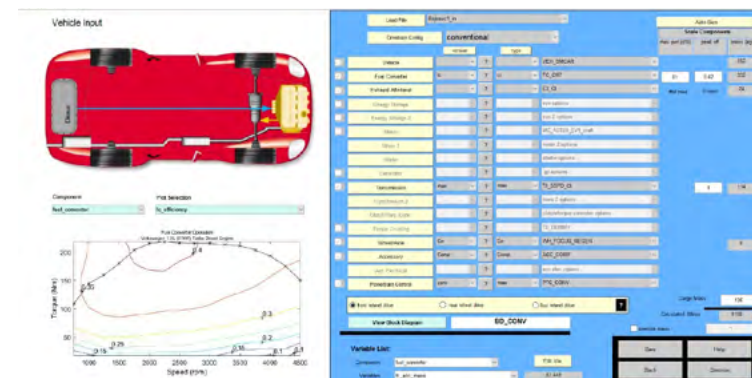

Prikaz odabranih parametara za konvencionalno vozilo / Presentation of the selected parameters for the conventional vehicle



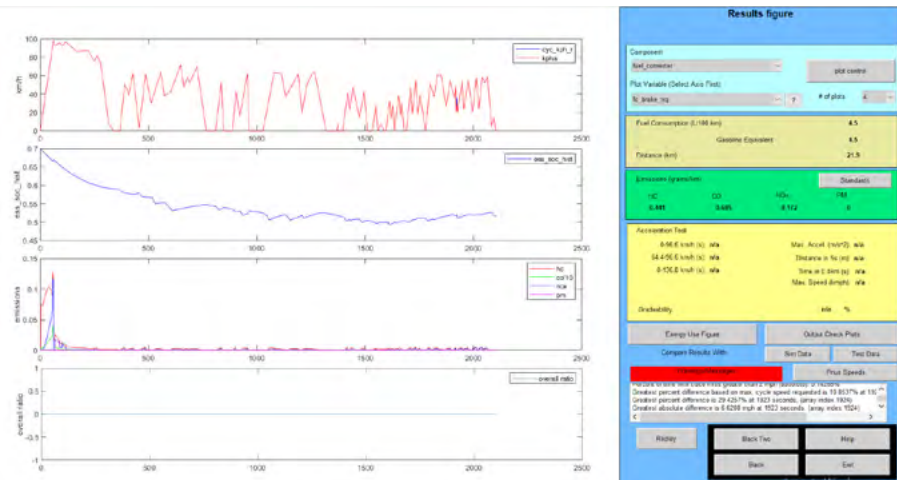

Rezultati simulacije hibridnog vozila – emisije  
/ Simulation results for the hybrid vehicle - emissions

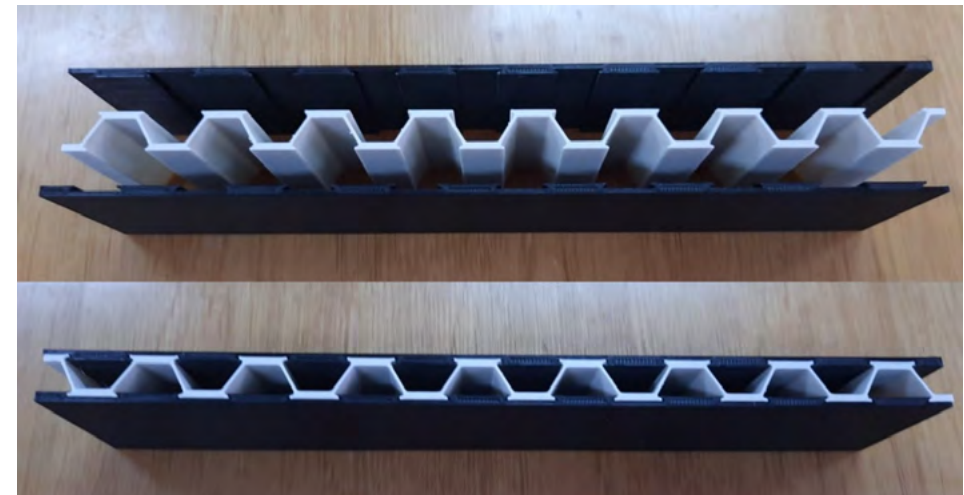

Kompozitna sendvič struktura PLA-ABS-PLA s trapeznom jezgrom prije i nakon spajanja  
/ Composite sandwich structure PLA-ABS-PLA with trapezoidal core before and after joining



Kompozitna sendvič struktura PLA-ABS-PLA s trapeznom jezgrom  
/ Composite sandwich structure PLA-ABS-PLA with trapezoidal core

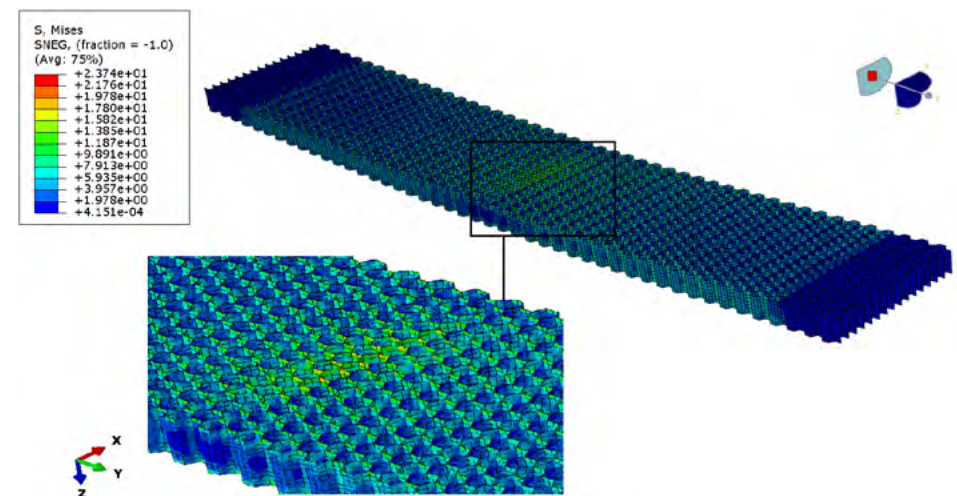

Naprezanja u sačastoj jezgri  
/ Stresses in the honeycomb core.

IME I PREZIME | NAME AND SURNAME:  
Martin Brcković

STUDIJSKI PROGRAM | STUDY PROGRAMME:  
Diplomski sveučilišni studij strojarstva  
/ Graduate University Study of Mechanical Engineering

NAZIV RADA | TITLE:  
Eksperimentalna i numerička analiza savijanja 3d printane kompozitne strukture  
Experimental and Numerical Analysis of the Bending of 3D Printed Composite Structure

MENTOR | SUPERVISOR:  
izv. prof. dr. sc. / Assoc. Prof. D. Sc. Marino Brčić

Sažetak: Summary:

U ovom radu je izvršena eksperimentalna i numerička analiza savijanja 3D printanih kompozitnih uzoraka u svrhu određivanja najbolje geometrije jezgre i konfiguracije materijala za uzorak. Za modeliranje testa savijanja u tri točke korištena je metoda konačnih elemenata, prethodno eksperimentalno izvršena. Korištenjem dobivenih numeričkih rezultata zaključeno je koja je geometrija jezgre i konfiguracija materijala dala najbolje rezultate.

Experimental and numerical analysis of the bending of a 3D printed composite structure were conducted and described in this paper. The aim was to determine the best core geometry and material configuration for the structure. The finite element method was used to model the three-point bend test, which had previously been experimentally conducted. The experimental and numerical results were compared to validate the numerical model. Using the experimental and numerical results gained from the experiments and tests, a conclusion was reached about which core geometry and material configuration had the best results.

IME I PREZIME | NAME AND SURNAME:

Daniel Ivaničić

STUDIJSKI PROGRAM | STUDY PROGRAMME:

Diplomski sveučilišni studij strojarstva

/ Graduate University Study of Mechanical Engineering

NAZIV RADA | TITLE:

**Numerička analiza i optimizacija topologije nosivog elementa**

Numerical Analysis and Topology Optimization of the Load-Bearing Element

MENTORI | SUPERVISORS:

prof. dr. sc. / Prof. D. Sc. Robert Basan

doc. dr. sc. / Assist. Prof. D. Sc. Tea Marohnić

Sažetak:

U ovom diplomskom radu provedena je i predstavljena eksperimentalna provjera rezultata optimizacije topologije 3D tiskanog konzolnog pločastog nosivog elementa primjenom tehnologije korelacije digitalne slike (DIC). Testni uzorci su 3D tiskani iz ABS i PET-G materijala pomoću FDM tehnologije. 3D geometrijsko parametarsko modeliranje nosivog elementa, numerička analiza metodom konačnih elemenata i optimizacija topologije provedene su pomoću računalnog programa Autodesk Inventor. Kako bi se uspješno definirao optimizacijski problem i dobili pouzdani rezultati, iznimno je važno pravilno definirati ulazne parametre analize kao što su značajke materijala i rubni uvjeti. Modul elastičnosti (Youngov modul) korištenih materijala (ABS i PET-G) eksperimentalno su određeni na uzorcima koji su također izrađeni tehnologijom 3D ispisa s istim postavkama kao i uzorci konzolnih ploča. Pomaci, naprezanja i deformacije u optimiziranim uzorcima određeni su numeričkom analizom. Za provjeru rezultata numeričke analize i optimizacije topologije pripremljena je posebna nosiva naprava za prihvat i opterećivanje uzoraka izrađenih metodom 3D ispisa te su izmjereni pomaci pomoću sustava za korelaciju digitalne slike GOM ARAMIS. Eksperimentom dobiveni rezultati uspoređeni su s rezultatima dobivenim numeričkom analizom optimiziranog uzorka konzolne ploče i pokazuju vrlo dobro slaganje i za ABS i za PET-G uzorke, s odstupanjem od oko 4 % odnosno 11 %. Rezultati ovog rada prezentirani su na 5. Međunarodnoj konferenciji o strukturnom integritetu i trajnosti (ICSID 2021) održanoj u rujnu 2021. godine u Dubrovniku te će biti objavljeni u zborniku radova konferencije.

Summary:

This master's thesis presents Digital Image Correlation (DIC) based experimental verification of topology optimisation of a 3D printed cantilever plate load-bearing element. Test samples were 3D printed from ABS and PET-G materials using FDM technology. A 3D geometrical parametric modelling of the element, FEA analysis and topology optimisation were performed using Autodesk Inventor computer software. In order to successfully define the optimisation problem and obtain reliable results, it is extremely important to properly define the analysis input parameters, such as material parameters and boundary conditions. Young's moduli of ABS and PET-G were determined experimentally on samples which were made using 3D printing technology with identical settings to cantilever plate samples. Displacements, stresses and strains in optimised samples were determined using FEA. To verify the FEA and topology optimisation results, an experimental setup for the holding and loading of 3D printed samples was prepared, and displacements were measured using the GOM ARAMIS digital image correlation system. Results obtained experimentally were compared with the results obtained through finite element analysis of the optimised cantilever plate sample and show very good agreement for both ABS and PET-G samples, with deviations of around 4% and 11% respectively. The results of this work were presented at the 5th International Conference on Structural Integrity and Durability (ICSID 2021) in September 2021 and will be published in the Conference Proceedings.



*Eksperimentalno-mjerni sustav s opterećenim uzorkom  
/ Experimental and measurement setup with loaded optimized sample*

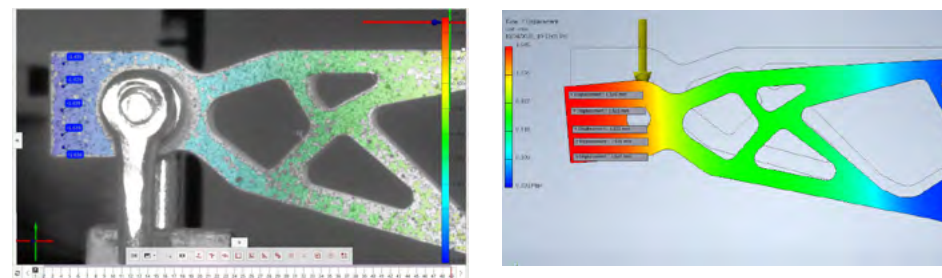

*Pomaci opterećenog uzorka izrađenog od ABS-a izmjereni DIC metodom  
i dobiveni numeričkom analizom  
/ Displacements of loaded optimised ABS sample obtained by DIC measurements  
and numerical analysis*

IME I PREZIME | NAME AND SURNAME:

Adriano Kovaček

STUDIJSKI PROGRAM | STUDY PROGRAMME:

Diplomski sveučilišni studij strojarstva

/ Graduate University Study of Mechanical Engineering

NAZIV RADA | TITLE:

Numerička analiza naprezanja zuba zupčanika

Numerical Stress Analysis of the Gear Tooth

MENTOR | SUPERVISOR:

prof. dr. sc. / Prof. D. Sc. Marina Franulović

Sažetak:

U ovome radu izvršena je provjera raspodjele naprezanja na boku i korijenu zuba pogonskog i gonjenog zupčanika uslijed zahvata. U prvom dijelu rada opisane su osnove zupčastih prijenosnika i teorijske osnove numeričke analize primjenom metode konačnih elemenata. Projektni i kontrolni proračun zahvata zupčanika za prijenos snage od 20 kW i brzinu vrtnje pogonskog zupčanika od 1750 min<sup>-1</sup> uz prijenosni omjer 3,5 izvršeni su prema ISO 6336 standardu pomoću programskog paketa KISSsoft uz procjenu relevantnih faktora. Definirana geometrija iz projektnog proračuna zatim je upotrebljena kao polazišna točka modeliranja i diskretizacije zupčanika u zahvatu. Numerička analiza metodom konačnih elemenata provedena je u programskom paketu Ansys Workbench. U svrhu validacije rezultata, na mreži konačnih elemenata proveden je test konvergencije. Rezultati numeričke analize zatim su uspoređeni sa rezultatima analitičkog proračuna na temelju čega je definiran zaključak ovog rada. Dobiveni rezultati numeričke analize u skladu su sa pretpostavkom da je numerička analiza primjenom metode konačnih elemenata dobra alternativa standardnim analitičkim proračunima raspodjele naprezanja u korijenu i na boku zuba. Sama numerička analiza pruža veće mogućnosti od standardnih analitičkih proračuna kada se govori o interpretaciji rezultata. Uspoređujući rezultate numeričke analize i rezultate dobivene analitičkim proračunom primjećuje se minimalna razlika. Usporedbom rezultata analize korijena zuba, kada su zupčanici opterećeni koncentriranom silom, i analize, kada su zubi u zahvatu, zaključuje se da su rezultati dobiveni numeričkom analizom kada su zubi opterećeni koncentriranom silom bliži rezultatima analitičkog proračuna, dok su rezultati zuba u zahvatu bliži stvarnom slučaju.

Summary:

This paper deals with the analysis of stress distribution on the flank and root area of a pinion and gear tooth caused by the meshing process. The first part of the paper describes the basics of gears and the theoretical foundations of numerical analysis using the finite element method. The design and control calculation of a gear system capable of transmitting 20 kW of power and with a rotational speed of the pinion of 1750 min<sup>-1</sup> with a gear ratio of 3.5 were performed according to ISO 6336 using KISSsoft software, with the assessment of relevant factors. The defined geometry from the design calculation was then used as a starting point for the modelling and discretisation of the meshed gears. A numerical analysis using the finite element method was performed using Ansys Workbench software. A convergence test was then performed on the defined finite element mesh as a measure of validity. The results of the numerical analysis were then compared with the results of the analytical calculation on the basis of which the conclusion of this paper was reached.

The obtained results showed that numerical analysis using the finite element method is a good alternative to standard analytical calculations of stress distribution on the root and tooth flank. A numerical analysis itself provides greater possibilities than standard analytical calculations when it comes to interpreting influencing factors. Comparing the results of the numerical analysis and the results obtained by analytical calculation, a minimal difference is noticed when a concentrated load is applied. Comparing the results of tooth root analysis when gears are loaded with the teeth in mesh, it is concluded that the results are somewhat different but are closer to the real stress values.

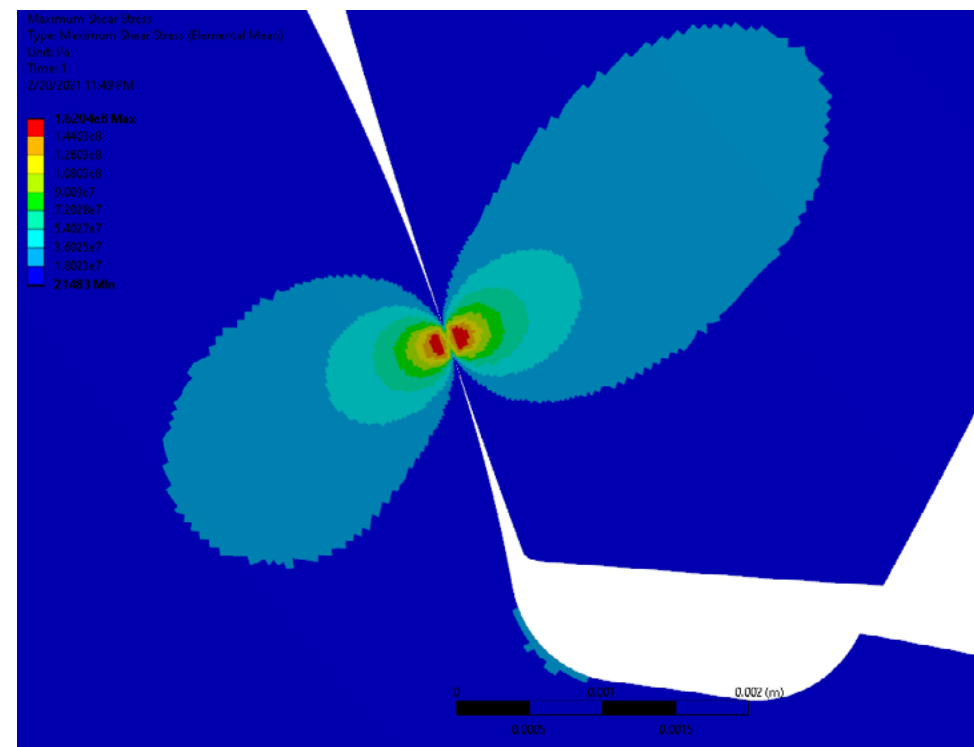

Najveća smična naprezanja na boku zuba dubini od 0,786b  
/ Maximum shear stress on teeth flanks at a depth of 0.786b

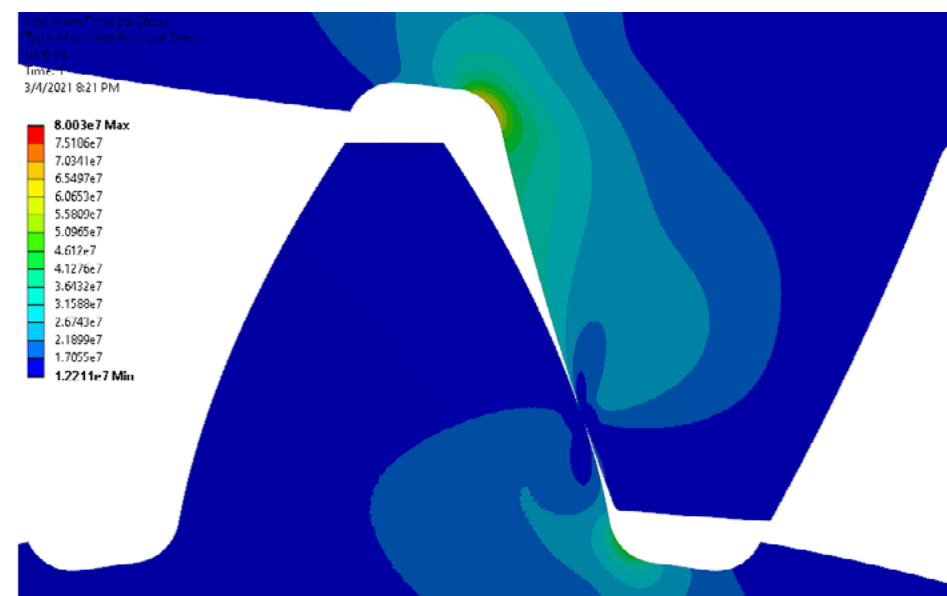

Najveća glavna naprezanja u korijenu zuba  
/ Maximum principal stresses on tooth roots

IME I PREZIME | NAME AND SURNAME:

Marko Mirković

STUDIJSKI PROGRAM | STUDY PROGRAMME:

Diplomski sveučilišni studij strojarstva

/ Graduate University Study of Mechanical Engineering

NAZIV RADA | TITLE:

Primjena podacima vođenih algoritama na dinamičkim sustavima

Application of Data Driven Algorithms on Dynamical Systems

MENTORI | SUPERVISORS:

prof. dr. sc. / Prof. D. Sc. Nelida Črnjarić-Žic

doc. dr. sc. / Assist. Prof. D. Sc. Stefan Ivić

Sažetak:

U ovome radu prikazana je teorijska podloga Koopmanovog operatora. To je linearni operator koji nelinearne dinamičke sustave pretvara u linearne. Kompromis te transformacije je žrtvovanje konačnosti dimenzija sustava za beskonačno mnogo dimenzija. Tek naglim razvojem računala omogućena je praktična primjena ovog pristupa. Jedan od najkorištenijih algoritama ove problematike je DMD (eng. Dynamic Mode Decomposition) algoritam. To je podacima vođen algoritam što znači da za analizu sustava nije potrebno poznavati jednadžbe koje taj sustav opisuje, već se cijela analiza temelji na izmjerenim podacima u različitim vremenskim trenucima. Za primjer analize, pomoću OpenFOAM simulacija, pripremljeni su podaci za nekoliko primjera iz dinamike fluida. Utvrđeno je da je moguće rekonstruirati sliku promatranih varijabli već za mali broj modova te da se pojedini sustav može opisati korištenjem nekoliko svojstvenih modova i svojstvenih vrijednosti sustava. Uz analize strujanja fluida dana je i analiza podataka dobivenih tijekom epidemije Sars-Cov 2 virusa. Predikcija kako će se razvijati epidemija moguća je uz pomno odabrane postavke analize kao što su veličine podataka za treniranje. Točnost same predikcije ovisi o promatranom broju dana. Na kraju rada dana su glavna razmatranja i prijedlozi za buduće implementacije ovakve metode.

Summary:

This paper presents the theoretical foundations of the Koopman operator. This is a linear operator that transforms nonlinear dynamical systems into linear systems. The trade-off of this transformation is the abandonment of the finiteness of the dimensions of the system in favour of an infinite number of dimensions. Only the rapid development of computers has enabled the practical application of this approach. One of the most commonly used algorithms for this problem is the DMD (Dynamic Mode Decomposition) algorithm. This is a data-driven algorithm, i.e. for system analysis it is not necessary to know the equations describing the system, but the whole analysis is based on the inclusion of measured data at different points in time. For testing purposes, data from several examples of fluid dynamics were processed using OpenFOAM simulations. It was found that it is possible to reconstruct the picture of the observed variables for a small number of modes and that a given system can be described with several eigenmodes and eigenvalues. In addition to the analyses of the flows, an analysis of the data obtained during the Sars-Cov 2 virus epidemic was also performed. Prediction of the evolution of the epidemic is possible with carefully chosen analysis settings such as the size of the training data. The accuracy of the prediction itself depends on the number of days observed. At the end of the paper, the main considerations and suggestions for future implementations of this method are given.

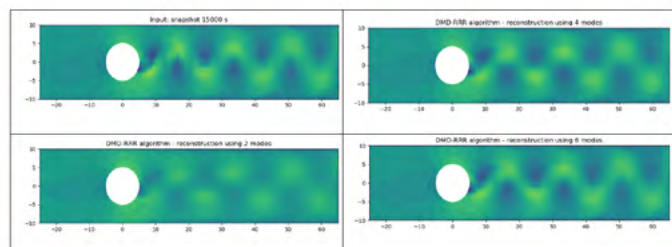

Rekonstrukcija brzina strujanja oko cilindra s različitim brojem Koopmanovih modova  
/ Reconstruction of the cylinder flow with different numbers of modes

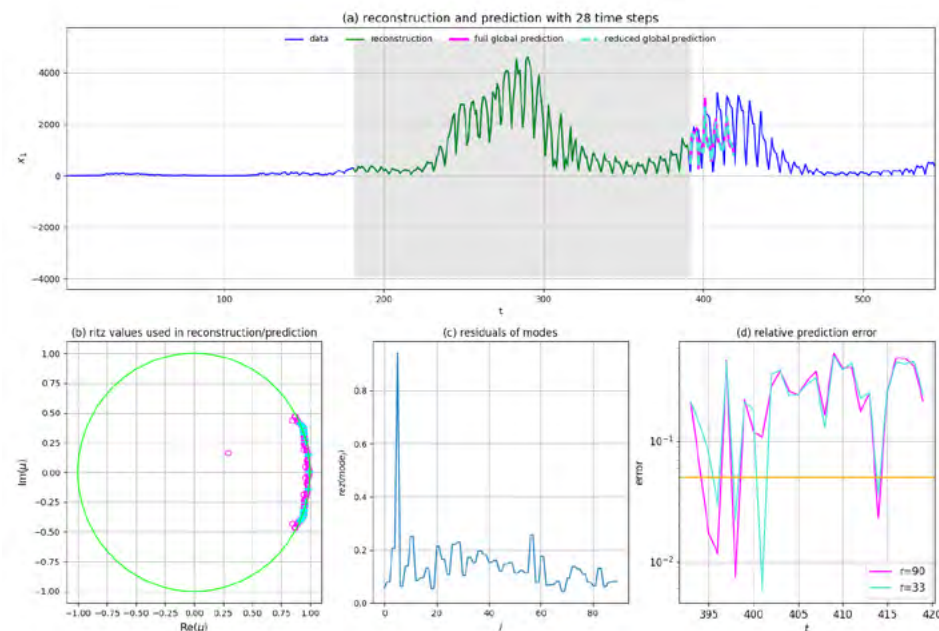

DMD predikcija novih slučajeva korona virusa u Hrvatskoj za 28 dana istrenirana na 212 dana  
/ DMD prediction of new coronavirus cases in Croatia for 28 days trained on 212 days

IME I PREZIME | NAME AND SURNAME:

Ana Škifić

STUDIJSKI PROGRAM | STUDY PROGRAMME:

Diplomski sveučilišni studij strojarstva

/ Graduate University Study of Mechanical Engineering

NAZIV RADA | TITLE:

Konstrukcija mehatroničkog uređaja za rehabilitaciju podlaktice i ručnog zgloba

Mechanical Engineering Design of a Forearm and Wrist Mechatronics Rehabilitation Device

MENTOR | SUPERVISOR:

prof. dr. sc. / Prof. D. Sc. Saša Zelenika

Sažetak:

Mehatronički uređaji za rehabilitaciju pacijenata s neurološkim oštećenjima ključni su u pogledu njihove fizičke rehabilitacije. Posebnu važnost u tom okviru ima rehabilitacija podlaktice i ručnog zgloba čija je funkcionalnost neizostavna u nesmetanom obavljanju svakodnevnih aktivnosti. S obzirom na zahtjeve osnovnih anatomskih obilježja, dosadašnje stanje tehnike na ovom području ruke i sigurnosne zahtjeve, u radu je konstrukcijski koncipirano više mogućih rješenja aktivnog rehabilitacijskog uređaja. Doista, aktivni uređaji pružaju značajne prednosti u odnosu na pasivne, budući da omogućavaju ritmičnosti i

Summary:

Mechatronic devices are a key factor in the successful physical rehabilitation of patients with neurological limitations. Forearm and wrist rehabilitation is especially important in this, as it is crucial in assuring the regaining of the most important activities and functionalities for daily living. Bearing in mind the basic anatomical features, the current state of the art in this field, as well as safety requirements, several design concepts for an active rehabilitation device are proposed. Active devices provide important advantages compared to passive ones, since they enable smooth repetitive motions. By

ponovljivost pokreta. Vrednovanjem predloženih koncepata dobivene su smjernice za konstrukciju konačnog rješenja. Predloženi uređaj wRIhab spada u skupinu egzoskelet uređaja i omogućava tri stupnja slobode gibanja u serijskoj konfiguraciji: rotaciju podlaktice, fleksiju i ekstenziju te radijalne i ulnarne devijacije ručnog zgloba. Sustav pokretanja zglobova sastoji se od istosmjernih motora bez četkica i planetarnog prijenosnika s prijenosnim omjerom 51:1, čime je postignut izlazni moment od 6,4 Nm.

evaluating the proposed concepts, guidelines for the construction of a final design solution are obtained. The proposed device, named wRIhab, belongs to a group of exoskeleton devices and enables the attainment of three degrees of freedom in a serial configuration: forearm pronation/supination, as well as flexion/extension and radial/ulnar deviations of the wrist. The respective actuation system is based on DC brushless motors coupled to planetary gearheads with a 51:1 reduction rate, which results in a 6.4 Nm output rotational torque.

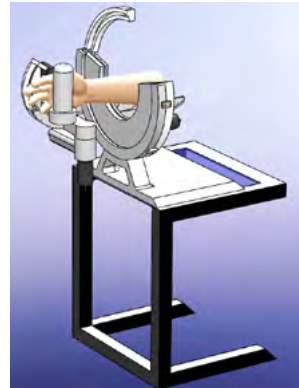
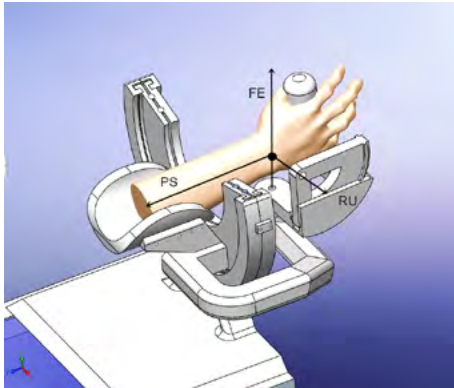

3D modeli razvijenog wRIhab mehatroničkog rehabilitacijskog uređaja  
/ 3D models of the developed wRIhab mechatronics rehabilitation device

SolidWorks. Nakon toga, izdvojen je simetričan segment geometrije koji se uvozi u programski paket ABAQUS u kojem je odrađena numerička analiza metodom konačnih elemenata. Za obje inicijalne geometrije provedena je analiza naprezanja, a postupkom optimizacije oblika presjeka dobivene su konture optimalne geometrije. Optimalna geometrija za oba stenta modelirana je u SolidWorksu te su rezultati provjereni ponovnim postupkom numeričke analize, ovoga puta za optimiziranu geometriju.

3D modelling software. Then, the symmetrical segment of the geometry was singled out and imported into ABAQUS for a FEM analysis. A stress analysis was conducted for both initial geometries, and the contours of the optimal geometry were obtained through the process of shape optimisation. The optimised geometry for both stents was also modelled in SolidWorks. Finally, the simulation was repeated, but this time for the optimised geometry.

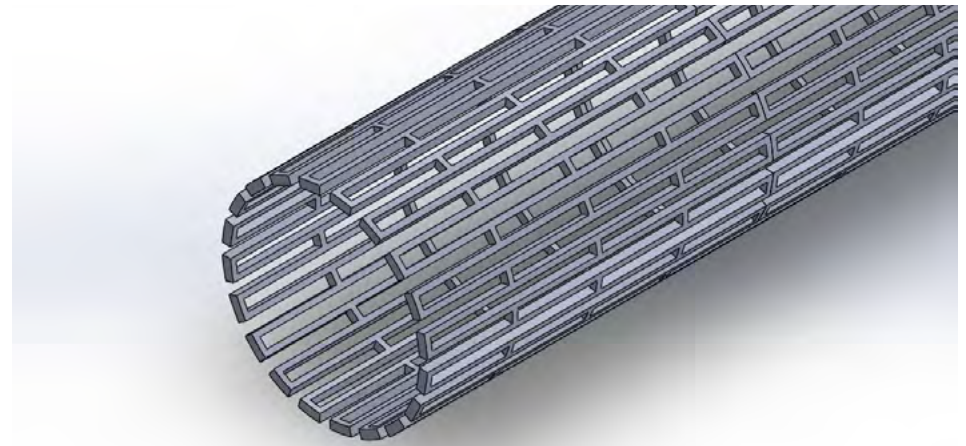

3D model stenta sa zatvorenom ćelijskom izvedbom  
/ 3D model of a stent with a closed cell design

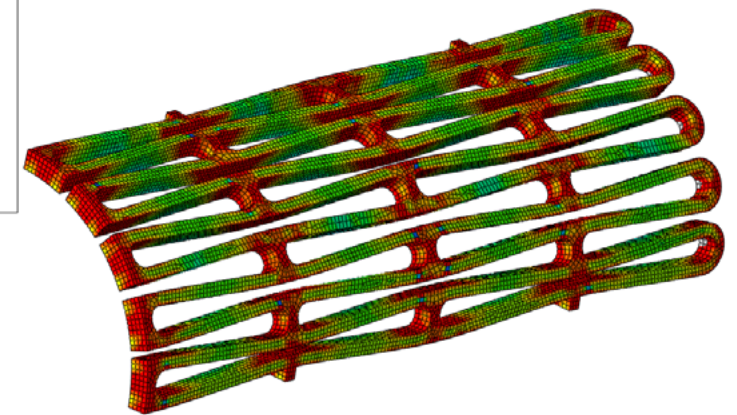
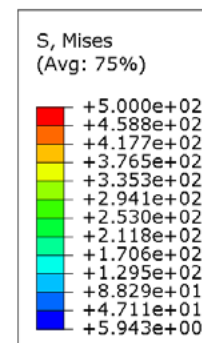

Korak kontrakcije za optimiziranu geometriju  
/ Contraction step for optimized geometry



IME I PREZIME | NAME AND SURNAME:  
Domagoj Vrtovšnik

STUDIJSKI PROGRAM | STUDY PROGRAM:  
Diplomski sveučilišni studij strojarstva  
/ Graduate University Study of Mechanical Engineering

NAZIV RADA | TITLE:  
Numerička analiza i optimizacija modela koronarnog stenta  
Numerical Analysis And Optimization of Coronary Stent Model

MENTOR | SUPERVISOR:  
izv. prof. dr. sc. / Assoc. Prof. D. Sc. Marino Brčić

Sažetak:

Cilj ovog diplomskog rada je numerička analiza i optimizacija geometrije koronarnog stenta za zadani materijal u radnim uvjetima. Kroz deset poglavlja, rad objašnjava medicinsku pozadinu problema, bavi se teorijskim razmatranjima vezanima uz mehaniku čvrstog tijela, opisuje postupak modeliranja geometrije koronarnog stenta, njegovu analizu i optimizaciju geometrije. Dvije početne geometrije, nastale po uzoru na stvarne geometrije koronarnih stentova, kreirane su pomoću programa za 3D modeliranje

Summary:

The goal of this thesis is the numerical analysis and structural optimisation of the coronary stent for given material in working conditions. Through its ten chapters, the paper gives the medical background of the problem, explains theoretical considerations related to solid state mechanics and describes the procedure for the modelling, finite element analysis and structural optimisation of coronary stent geometry. Two of the initial geometries were modelled on existing stent geometries and created in SolidWorks



## 2.4 ALUMNI TFR

### ALUMNI TFR



Alumni klub Tehničkog fakulteta Sveučilišta u Rijeci, skraćena naziva ALUMNI TFR, udruga je osnovana s primarnim ciljem uspostave i jačanja veza i suradnje između bivših studenata Tehničkoga fakulteta, ali i između bivših studenata međusobno. Udruga je osnovana pod nazivom Akademski klub doktora znanosti, magistara znanosti, diplomiranih inženjera i inženjera Tehničkoga fakulteta Sveučilišta u Rijeci na Osnivačkoj skupštini održanoj u Mramornoj dvorani Pomorskoga i povijesnoga muzeja Hrvatskoga primorja u Rijeci, dana 24. studenoga 2000. godine, u sklopu obilježavanja 40 godina djelovanja Fakulteta.

Svrha ALUMNI TFR je očuvanje tradicije Tehničkoga fakulteta Sveučilišta u Rijeci, promicanje ugleda Fakulteta u Republici Hrvatskoj i inozemstvu, skrb za razvitak i napredak Fakulteta, njegovanje i razvitak etike inženjerskoga poziva, utjecaj na stvaranje javnoga znanstvenog i stručnog mišljenja o svim bitnim pitanjima razvoja struke i znanosti te njihove primjene, utjecaj na razvitak i napredak spoznaje o potrebi očuvanja prirode i čovjekova okoliša, izgradnja i jačanje veza i suradnje između bivših studenata i Fakulteta, poticanje i uspostava veza i suradnje Fakulteta i sličnih obrazovnih, razvojnih i istraživačkih institucija u Republici Hrvatskoj i u svijetu, promicanje ugleda inženjerske struke te uspostava i razvijanje suradnje sa sličnim udrugama kod nas i u svijetu.

Predsjednik ALUMNI TFR je doc. dr. sc. Vedran Kirinčić, dipl. ing., potpredsjednici su: prof. dr. sc.

The Alumni Club of the Faculty of Engineering of the University of Rijeka (ALUMNI TFR) is an association established with the primary aim of fostering and strengthening connections and cooperation between former alumni and the Faculty, and also among alumni themselves. The association, founded with the title of Academic Fellowship, comprises holders of PhDs, and master's and bachelor's degrees (including former graduate and vocational engineers) of the Faculty of Engineering of the University of Rijeka. It was established at its inaugural meeting held at the Marble Hall of the Maritime and History Museum of the Croatian Littoral in Rijeka on 24 November 2000 to mark the 40th anniversary of the Faculty.

The purpose of ALUMNI TFR is to preserve the tradition of higher education of the Faculty of Engineering of the University of Rijeka, to promote the reputation of the Faculty in the Republic of Croatia and abroad, to care for its development and progress, to nurture and foster ethics in the engineering profession, to influence the creation of public scientific and professional opinion on all important issues in the development of the profession and science, and to encourage the development and advancement of awareness of the need to preserve nature and the environment. Its aim is also to strengthen relations and cooperation between former alumni and the Faculty, to encourage the establishment of links and cooperation between the Faculty and similar educational, developmental and research

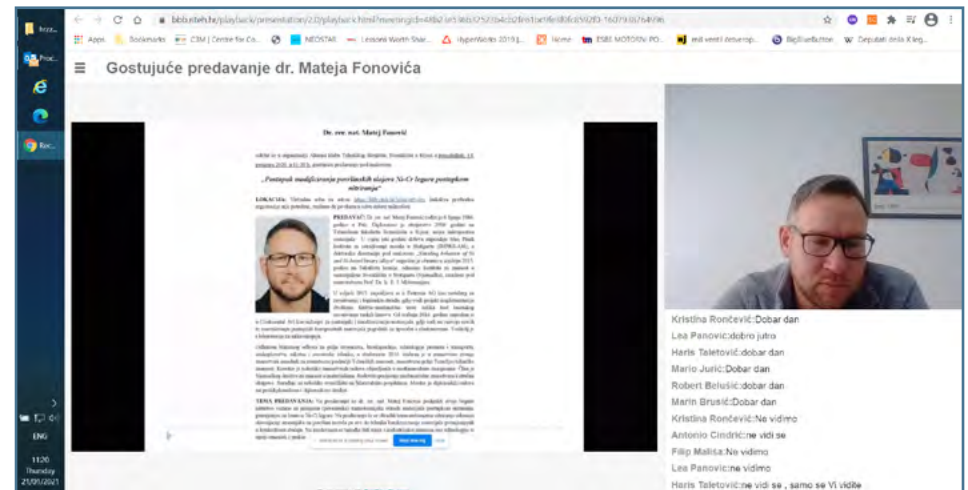

Robert Basan, dipl. ing. i Danko Venturini, dipl. ing., a tajnik je doc. dr. sc. Rene Prenc, dipl. ing. U predsjedništvu su: prof. dr. sc. Robert Basan dipl. ing., prof. dr. sc. Bernard Franković, dipl. ing., doc. dr. sc. Vladimir Glažar, dipl. ing., doc. dr. sc. Vedran Kirinčić, dipl. ing., dr. sc. Serđo Klapčić, dipl. ing., Neven Kundija, ing., doc. dr. sc. Goran Mauša, dipl. ing., Ante Maras, dipl. ing., Teuta Duletić, dipl. ing., prof. dr. sc. Zoran Mrša, dipl. ing., mr. sc. Vladimir Valentić, dipl. ing., prof. dr. sc. Duško Pavletić, dipl. ing., ujedno i dekan Tehničkoga fakulteta, prof. dr. sc. Jasna Prpić-Oršić, dipl. ing., Siniša Reljić, dipl. ing. i Danko Venturini, dipl. ing.

U organizaciji ALUMNI TFR, tijekom ak. god. 2020./2021., realizirane su sljedeće aktivnosti:

- 8. 12. 2020., u suorganizaciji s Regionalnom energetska agencijom Kvarner, Primorsko-goranskom županijom i MBA studijem „Ekonomija energetskega sektora“ Ekonomskog fakulteta Sveučilišta u Rijeci, putem platforme Zoom, održan je „Energetski dan“ u skupu kojeg je napravljeno niz besplatnih i za javnost otvorenih izlaganja s temama iz područja energetske tranzicije i mobilnosti, 8.12.2020. In cooperation with the Kvarner Regional Energy Agency, Primorje-Gorski Kotar County and the MBA Energy Economics postgraduate course of the Faculty of Economics and Business of the University of Rijeka, an "Energy Day" was held via Zoom, including a series of free and open to the public presentations on topics in the field of energy transition and mobility.
- 10. 12. 2020., u suorganizaciji s tvrtkom Otok Krk energija, održan je webinar na temu: „Održivi promet i eMobilnost kao novi koncept u energetici i prometu“, pri čemu je cilj rasprave bio istražiti i osvijetliti elektromobilnost kao čišću, alternativnu opciju mobilnosti, koja može prevoditi zelenu tranziciju ka održivosti,



10.12.2020. In cooperation with the Island of Krk Energy company, a webinar was held on the topic of "Sustainable transport and eMobility as a new concept in energy and transport". The aim of the discussion was to explore and shed light on electromobility as a cleaner, alternative mobility option which can lead a green transition towards sustainability.

- 14. 12. 2020. održano je predavanje dr. rer. nat. Mateja Fonovića, Continental AG s temom „Postupak modificiranja površinskih slojeva Ni-Cr legure postupkom nitriranja“, 14.12.2020. A lecture was held on the topic of "Procedure for modifying the surface layers of Ni-Cr alloy by nitriding" by Dr. rer. nat. Matej Fonović, Continental AG.,
- 21. 1. 2021. održano je predavanje Veljka Jardasa, dipl. ing. el., Jatro d.o.o. s temom „Elektrosustavi u brodogradnji“, 21.1.2021. A lecture on "Electrical systems in shipbuilding" was held by Veljko Jarda, M.Eng, Jatro Ltd.,
- 17. 2. 2021. održan je webinar na temu: „Zašto nam je potrebna rEVolucija u mobilnosti i transportu“, u kojem je bilo riječi o klimatskim promjenama i mogućnostima za smanjenje potrošnje i emisija dekarbonizacijom prometnog sektora. 17.2.2021. A webinar on the topic "Why we need a rEVolution in mobility and transport" was held, which discussed climate change and opportunities to reduce consumption and emissions by decarbonising the transport sector.
- 22. 2. 2021. i 13. 5. 2021. održan je sastanak Predsjedništva Alumni kluba Tehničkog fakulteta u Rijeci. 22.2.2021 and 13.5.2021. A meeting of the Presidency of ALUMNI TFR took place.
- 11. 3. 2021. održan je sastanak Skupštine Alumni kluba Tehničkog fakulteta u Rijeci. 11.3.2021. A meeting of the Assembly of ALUMNI TFR took place.



## Veljko Jarda, dipl. ing. el.

održat će u organizaciji Alumni kluba Tehničkog fakulteta, Sveučilišta u Rijeci, u četvrtak, 21. siječnja 2021. u 14:00 h gostujuće predavanje pod naslovom:

### „Elektro sustavi u brodogradnji“

**LOKACIJA:** Virtualna soba na adresi <https://bbb.riteh.hr/b/ren-k4j-d2z> (nikakva prethodna registracija nije potrebna; molimo da po ulazu u sobu stišate mikrofon).



**PREDAVAČ:** Dipl. ing. el. Veljko Jarda rođen je 19. kolovoza 1986. godine u Rijeci. Diplomirao je elektrotehniku 2009. godine na Tehničkom fakultetu Sveučilišta u Rijeci, smjer automatika.

Za vrijeme studiranja bio je Microsoft student partner i predsjednik udruge studenata elektrotehnike EESTEC LC Rijeka te korisnik stipendije grada Rijeke kao jedan od 30 najperspektivnijih studenata svoje generacije.

U siječnju 2010. zapošljava se u poduzeću Werkos na poslovima automatizacije u prometu i instalacije meteo stanica.

Od 2011. godine zapošljava se u poduzeću Bronte d.o.o. (u vlasništvu norveške grupacije Ulstein) gdje prelazi u područje projektiranja elektro sustava u brodogradnji. Od 2012. pokreće vlastitu tvrtku Jatro d.o.o. u kojoj ima funkciju direktora i aktivno vodi tim od 10 diplomiranih inženjera elektrotehnike čija osnovna djelatnost je izrada projektne i radioničke elektro dokumentacije za razne tipove brodova. U zadnjih devet godina sudjelovao je na nizu projekata za etablirane strane firme kao što su Rolls Royce Marine, Kongsber Maritime, Kleven, Ulstein itd.

U razdoblju od 2014. do 2018. bio je asistent (honorarni rad) na zavodu za automatiku na Tehničkom fakultetu Sveučilišta u Rijeci.

**TEMA PREDAVANJA:** Na predavanju će dipl. ing. el. Veljko Jarda podijeliti svoje iskustvo vezano za elektro sustave u brodogradnji. Uvodno će kratko predstaviti tvrtku Jatro d.o.o. i njen opseg djelatnosti, a nakon toga će studentima pokušati u kratkim crtama dati pregled elektroenergetskog sustava broda, brodske automatike i ostalih brodskih sustava vezanih za elektro struku.

## 2.5 ČASOPIS "ENGINEERING REVIEW" THE JOURNAL "ENGINEERING REVIEW"



Tehnički fakultet Sveučilišta u Rijeci ima dugu tradiciju izdavanja znanstvenih radova. Publiciranje znanstvenih radova djelatnika Tehničkog fakulteta seže u 1970. godinu kada započinje tiskanje Zbornika radova. Godine 1988. spomenuta edicija mijenja naziv u Zbornik Tehničkog fakulteta Rijeka, a 1995. godine uspostavlja se naziv Engineering Review, pod kojim se časopis i danas tiska.

Sve spomenute edicije bile su na raspolaganju za objavu radova, kako nastavnog osoblja samog Fakulteta, tako i svima zainteresiranima. Fakultet nastoji zainteresirati znanstvenu javnost za publiciranje znanstvenih radova radi širenja razmjene znanstvenih postignuća temeljenih na istraživačkom radu. Područja iz kojih se u časopisu mogu objavljivati radovi prvenstveno obuhvaćaju strojarstvo, brodogradnju, temeljne tehničke znanosti, elektrotehniku, računalne znanosti i građevinarstvo. U ovom smislu časopis predstavlja jedan od rijetkih medija za publiciranje radova iz vrlo širokog dijapazona tehničkog područja. Razmatraju se i radovi koji su kvalitetni, a nisu izravno iz tehničkog područja, već mogu biti, primjerice, iz prirodnih znanosti, s određenom poveznicom s područjem tehnike. Nakon potpisanog ugovora o suizdavaštvu časopisa Engineering Review, između Tehničkog fakulteta Sveučilišta u Rijeci i Građevinskog fakulteta Sveučilišta u Rijeci (2011.g.), nastavljaju se aktivnosti oko izdavanja pod vodstvom prof. dr. sc. Josipa Brnića, profesora emeritusa.

Urednički odbor časopisa Engineering Review, od 2020. promijenio je sastav koji nastavlja politiku znanstvene izvrsnosti, pod vodstvom glavnih urednika Marine Franulović i Domagoja Lanca. Ostali urednici svojom ekspertizom pokrivaju pojedina znanstvena polja: Marino Brčić - strojarstvo i temeljne tehničke znanosti; Boris Delač i Kristina Marković – strojarstvo; Aleksandra Deluka Tibljaš i Ivana Štimac Grandić – građevina; Dubravko Franković i Saša Vlahinić – elektrotehnika; Dario Ijkić – interdisciplinarne i temeljne tehničke znanosti; Jonatan Lerga

The Faculty of Engineering of the University of Rijeka has a long tradition of publishing scientific papers. The publication of scientific papers by the employees of the Faculty of Engineering dates back to 1970, when the first issue of Proceedings was published. In 1988, this edition was renamed The Proceedings of the Rijeka Faculty of Engineering, and finally in 1995 the journal was renamed again as Engineering Review, its present title.

All these editions have published papers written not only by the teaching staff of the Faculty but also by other interested authors. The Faculty makes every effort to arouse the interest of the scientific community in the publication of scientific papers, all with the aim of disseminating and sharing scientific achievements based on research work. Papers eligible for publication in the journal are primarily those from the fields of mechanical engineering, naval architecture, fundamental engineering sciences, electrical engineering, computer engineering and civil engineering. In this sense, the journal is one of the few that publish papers covering a wide range of engineering areas. However, quality papers not directly from the engineering area are also taken into consideration, for instance, those from the field of natural sciences but linked in some way to the area of engineering. The Faculty of Engineering of Rijeka University and the Faculty of Civil Engineering of Rijeka University entered into a contract for a co-edition (2011) of Engineering Review, thus ensuring the continuation of its publication under the guidance of Editor-in Chief, Professor Emeritus Josip Brnić, DSc.

Since 2020, the Editorial Board of the Engineering Review journal has changed but continues its policy of scientific excellence under the guidance of its editors-in-chief, who are Marina Franulović and Domagoj Lanc. Editors are now appointed for their expertise in different scientific fields: Marino Brčić - mechanical engineering and fundamental technical sciences; Boris Delač and Kristina Marković – mechanical engineering;

i Goran Mauša – računarstvo i Marko Valčić – brodogradnja. David Liović i Fran Torbarina brinu se za postupak izdavanja, a za kvalitetu izražaja brine se Alenka Šunjić-Petrc. Računalnu podršku i rješenja pruža Tatjana Škorjanc. Urednički savjet je međunarodnog karaktera i vrlo širok i daje dodatnu snagu časopisu.

Časopis Engineering Review indeksiran je u: Aluminum Industry Abstracts, Advanced Polymers Abstracts, Cambridge Scientific Abstract (CSA), Ceramic Abstracts/World Ceramics Abstracts, Composites Industry Abstracts, Computer and Information Systems Abstracts, Copper Technical Reference Library, Corrosion Abstracts, Electronics and Communications Abstracts, Engineered Materials Abstracts, High Technology Research Database with Aerospace, Inspec, Mechanical & Transportation Engineering Abstracts, METADEX, SCImago, SCOPUS, Web of Science (Emerging Sources Citation Index, od 2015. god.).

Temeljem SCIMAGO kategorizacije rangiranja časopisa, u 2020. godini svrstan je u Q3 (treća kvartila). Časopis je uređen za elektroničku obradu svih podataka i elektroničku komunikaciju, od prijave radova do recenzentskih postupaka i priopćavanja rezultata podnositeljima (autorima) radova. Ima široku bazu domaćih i inozemnih recenzentata koja se stalno dopunjava. Svaki rad recenziraju najmanje dva recenzenta od kojih je najmanje jedan inozemni. Za prihvatanje rada niti jedna recenzija ne smije biti negativna. Časopis se objavljuje na engleskom jeziku, izlaze tri broja godišnje, a radovi su dostupni online (Hrčak, Tehnički fakultet u Rijeci) i u tiskanom obliku. Časopis također može objaviti određeni broj kvalitetnih radova s kongresa, a njihova kvaliteta mora biti zagarantirana jednom recenzijom kongresa i jednom novom recenzijom. Spomenuti radovi idu u prijavi istom procedurom kao i svi drugi radovi. Na kraju valja spomenuti kako je zainteresiranost za publiciranjem radova u časopisu velika, a ponude za objavljivanjem dolaze iz inozemstva i iz Hrvatske. Ovakvoj zainteresiranosti svakako doprinosi uređeni sustav prijave, recenzija, indeksiranost i komunikacija s autorima.

Aleksandra Deluka Tibljaš and Ivana Štimac Grandić – civil engineering; Dubravko Franković and Saša Vlahinić – electrical engineering; Dario Ijkić – interdisciplinary and fundamental technical sciences; Jonatan Lerga and Goran Mauša – computing, and Marko Valčić – naval architecture. David Liović and Fran Torbarina take care of the publishing process, and Alenka Šunjić-Petrc looks after the quality of expression. Assistance with computer solutions is provided by Tatjana Škorjanc. The Editor Advisory Board has an international character and its openness gives additional power to the journal.

Engineering Review has the following indexing: Aluminium Industry Abstracts, Advanced Polymers Abstracts, Cambridge Scientific Abstracts (CSA), Ceramic Abstracts / World Ceramics Abstracts, Composites Industry Abstracts, Computer and Information Systems Abstracts, Copper Technical Reference Library, Corrosion Abstracts, Electronics and Communications Abstracts, Engineered Materials Abstracts, High Technology Research Database with Aerospace, Inspec, Mechanical & Transportation Engineering Abstracts, METADEX, SCImago, SCOPUS, and Web of Science (Emerging Sources Citation Index from 2015).

According to the SCImago categorisation of journals for 2020, Engineering Review was included in Q3 (the third quartile). The journal uses electronic processing of all data, so that information on paper applications, review procedures and results are electronically communicated to the authors. The journal has a broad base of national and international reviewers, which is constantly supplemented. Each paper is reviewed by at least two referees, one of whom must be foreign. For the acceptance of the paper, all reviews have to be positive. The journal is published in English, in three issues annually, and the papers are available online (Hrčak, Faculty of Engineering Rijeka) and in printed form. The journal can also include a certain number of quality papers from a congress, provided that their quality is guaranteed by one review of the congress and another new review. These papers undergo the same application procedure as all other papers. Finally, it is worth mentioning that a lot of authors from Croatia and abroad have shown an interest in publishing their scientific papers in Engineering Review. Communication with authors, and an ordered system of application, review and indexing make a significant contribution to the importance of the journal.





## 2.6 DOKTORSKE DISERTACIJE OBRANJENE U AKADEMSKOJ GODINI 2020./2021.

DOCTORAL DISSERTATIONS DEFENDED IN  
ACADEMIC YEAR 2020/2021



64

**IME I PREZIME | NAME AND SURNAME:**

Vladimir Pelić

**POLJE | SCIENTIFIC FIELD:**

Strojarstvo / Mechanical Engineering

**NAZIV RADA | TITLE:**

Optimizacija brodskog srednjookretnoga dizelskog motora u sustavu električne propulzije

Optimization of marine medium speed diesel engine for electric propulsion system

**MENTOR | SUPERVISOR:**

prof. dr. sc. / Prof. D. Sc. Tomislav Mrakovčić

**DATUM OBRANE | DATE OF DEFENCE:**

15. 1. 2021.

Sažetak:

Predbrodska pogonska postrojenja postavljaju se sve veći zahtjevi s obzirom na energetske učinkovitost i ekološku prihvatljivost. Kako bi se ispunili postavljeni zahtjevi, primjenjuju se različite mjere, odnosno tehnologija za smanjenje emisije štetnih tvari nastalih procesom izgaranja u cilindru motora. U radu se analizira utjecaj primarnih mjera koje imaju direktan utjecaj na odvijanje procesa izgaranja, kao i na nastanak NOX. Za provedbu istraživanja pomoću numeričkog modela rada motora razvijen je odgovarajući računalni program. Provjera numeričkog modela i računalnog

Summary:

Ship propulsion systems are facing increasing demands in terms of energy efficiency and environmental friendliness. In order to meet the set requirements, various measures or technologies have been applied to reduce the emission of harmful substances that occur during the combustion process in the engine cylinder. This paper analyses the impact of primary measures that have a direct effect on the combustion process, as well as on the formation of NOX. An appropriate computer program has been developed to conduct research using a numerical model of engine operation. The

programa provedena je pomoću podataka koje daje proizvođač i podataka dobivenih mjerenjima za vrijeme probnih plovidbi. Primjenom numeričkog modela dizelskog motora provedeno je istraživanje utjecaja kasnijeg početka ubrizgavanja, ranijeg zatvaranja usisnog ventila (Millerov proces) i podijeljenog ubrizgavanja na učinkovitost i emisiju NOX. Utjecaj navedenih mjera na rad motora analiziran je s ciljem optimizacije rada srednjookretnoga dizelskog motora u sustavu dizel-električne propulzije broda. Primjena umjerenog kasnijeg početka ubrizgavanja goriva dovodi do smanjenja emisije NOX, uz relativno malo smanjenje učinkovitosti i blagi porast temperature ispušnih plinova. Ranije zatvaranje usisnog ventila, uz odgovarajuće povećanje tlaka u usisnom kolektoru, omogućuje znatnije smanjenje emisije NOX, a da pri tom ne dođe do smanjenja učinkovitosti. Rezultati istraživanja pokazali su kako primjena odgovarajuće sheme podijeljenog ubrizgavanja goriva omogućuje smanjenje emisije NOX uz relativno malo smanjenje učinkovitosti. Usporedba dobivenih rezultata s osnovnim motorom pokazuje kako je istovremenom primjenom navedenih mjera moguće ostvariti znatno smanjenje emisije NOX uz minimalni utjecaj na učinkovitost, što je i bio cilj rada.

verification of the numerical model and the computer program was carried out using the data provided by the manufacturer and the data obtained by measurements during sea trials. Using a numerical model of a diesel engine, a study of the impact of later injection onset, earlier closing of the intake valve (Miller process) and split injection on efficiency and NOX emission was conducted. The impact of these measures on engine operation was analysed with the aim of optimising the operation of a medium-speed diesel engine in the diesel-electric propulsion system of a ship. The application of a moderately later start of fuel injection leads to a reduction in NOX emissions with a relatively small reduction in efficiency and a slight increase in exhaust temperature. Earlier closing of the intake valve, with a corresponding increase in the pressure in the intake manifold, allows a significant reduction in NOX emissions without reducing efficiency. The results of the study showed that the application of an appropriate split fuel injection scheme allows the reduction of NOX emissions, with a relatively small reduction in efficiency. A comparison of the obtained results with a basic engine shows that the simultaneous application of these measures can achieve a significant reduction in NOX emissions with minimal impact on efficiency, which was the aim of the work..



65

**IME I PREZIME | NAME AND SURNAME:**

Nikola Turk

**POLJE | SCIENTIFIC FIELD:**

Elektrotehnika / Electrical Engineering

**NAZIV RADA | TITLE:**

Regulacija bezležajnog motora s izraženom nelinearnom ovisnošću razvijene magnetske sile o strujama

Control structure for bearingless electrical drive with nonlinear dependency between developed magnetic force and currents

**MENTOR | SUPERVISOR:**

izv. prof. dr. sc. / Assoc. Prof. D. Sc. Neven Bulić

**DATUM OBRANE | DATE OF DEFENCE:**

12. 2. 2021.

Sažetak:

Bezležajni motori spadaju u specijalnu vrstu električnih strojeva koji umjesto mehaničke koriste magnetsku suspenziju rotora. Korištenje magnetske suspenzije rotora eliminira potrebu za korištenjem mehaničkih ležajeva i omogućuje rad motora u kojem rotor nema nikakav fizički kontakt sa statorom. Bezležajni motori imaju prednosti kao što su dugi životni vijek, niski troškovi održavanja, ne postoji potreba za korištenjem maziva, nema potrebe za brtvljenjem

Summary:

Bearingless motors belong to a special type of electric machine that uses a magnetic suspension instead of a mechanical one to hold a rotor in the air gap, avoiding physical contact between the rotor and stator. The use of a rotor magnetic suspension eliminates the need for mechanical bearing usage and allows a motor operation in which the rotor has no physical connection with the stator over the classical bearing system. Therefore, bearingless motors

i omogućuju hermetičku razdvojenost statora i rotora. Navedene prednosti čine bezležajne motore veoma pogodnim za aplikacije u kojima se zahtijeva visoka čistoća. Upotreba magnetske suspenzije (magnetske levitacije) podrazumijeva održavanje rotora u centralnom položaju korištenjem isključivo magnetskih sila, što predstavlja jednu od glavnih problematika kojom se bavi područje bezležajnih motora. Problem magnetske suspenzije rotora rješava se odgovarajućim dizajnom i konstrukcijom motora, što, između ostaloga, podrazumijeva upotrebu većeg broja senzora, višefazni izvor napajanja i digitalni sustav upravljanja. Pojednostavljenje konstrukcije bezležajnog motora postignuto je uvođenjem bezležajnog motora s rotorom u obliku diska. Korištenje rotora u obliku diska omogućuje pasivnu stabilizaciju rotora u tri stupnja slobode njegova gibanja. Stabilizacija rotora u preostala dva stupnja slobode gibanja postiže se aktivnom stabilizacijom (upravljanjem strujama). Aktivna stabilizacija ostvaruje se regulacijom. Uslijed postojanja potrebe za aktivnom stabilizacijom rotora, može se zaključiti da je regulacijska struktura neophodna za rad bezležajnog motora. Većina suvremenih bezležajnih motora posjeduje linearnu ovisnost razvijenih sila o strujama motora, te su posljedično i regulacijske strukture bezležajnih motora temeljene na pretpostavci linearne ovisnosti razvijene sile o strujama. Međutim, kod određenih vrsta bezležajnih motora, posebice kod bezležajnih motora s reluktantnim rotorom, nije moguće zanemariti nelinearnu ovisnost razvijenih sila o strujama. Ovaj rad bavi se izradom regulacijske strukture bezležajnog motora u slučaju kada pretpostavka linearne ovisnosti razvijene sile o strujama nije ispunjena. U radu su opisani svi važni koraci od kojih se sastojalo provedeno istraživanje: izradu modela, razvoj nove regulacijske strukture, njeno pojednostavljenje u svrhu implementacije, implementacija razvijene regulacijske strukture na digitalni sustav upravljanja bezležajnog motora i eksperimentalne provjere razvijene regulacijske strukture.

have advantages over classical motors, such as a long service life, low maintenance costs, no usage of lubricants, no need for sealing, and they allow the hermetic separation of the stator and rotor. These advantages make bearingless motors very suitable for applications where a high degree of cleanliness is required. The use of magnetic suspension (magnetic levitation) involves keeping the rotor in a central position using only magnetic forces, which is one of the main issues in bearingless motor operations. The problem of the magnetic suspension of the rotor is solved by the appropriate design and construction of the motor, which among other things implies the use of a large number of sensors, a multi-phase power supply, and a specially designed digital control system. The simplification of the construction of the bearingless motor was achieved with the introduction of a bearingless motor with a disk-shaped rotor. The usage of a disk-shaped rotor allows passive stabilisation of the rotor movement in three degrees of freedom. Rotor stabilisation in the remaining two degrees of freedom is achieved by active stabilisation (current control). Active stabilisation is achieved by motor current regulation with the control structure necessary for the proper operation of a bearingless motor. Most modern bearingless motors have a linear dependence between the developed forces in the motor and motor currents. This leads to the fact that bearingless motor control structures are based on the assumption of a linear relationship between the developed forces on the rotor and motor currents. However, in certain types of bearingless motor, especially in the case of bearingless motors with a pronounced reluctance on the rotor side, the nonlinear dependence of the developed forces and the motor currents cannot be neglected. The focus in this thesis is on the development of the novel nonlinear bearingless motor control structure for cases when there is no linear dependence between the developed force on the rotor and the motor currents. In this work, all the steps of the research are presented. This includes: bearingless motor simulation model development, the development and testing of a new control structure based on a nonlinear bearingless motor model, model reduction techniques for implementation, implementation of the newly developed nonlinear control structure in the bearingless motor digital control system, and experimental verification of the developed nonlinear control structure on a laboratory prototype.

**IME I PREZIME | NAME AND SURNAME:**

Valter Uran

**POLJE | SCIENTIFIC FIELD:**

Strojarstvo / Mechanical Engineering

**NAZIV RADA | TITLE:**

Utjecaj skalabilnosti na optimalno formiranje višepredmetnih rekonfigurabilnih proizvodnih sustava

Scalability impact on optimal design of multi-product reconfigurable production systems

**MENTORI | SUPERVISORS:**

prof. dr. sc. / Prof. D. Sc. Tonči Mikac

doc. dr. sc. / Assist. Prof. D. Sc. Sandro Doboviček

**DATUM OBRANE | DATE OF DEFENCE:**

22. 2. 2021.

Sažetak:

Današnja proizvodnja susreće se s izazovima izrazito promjenjivih zahtjeva tržišta koje karakterizira velika fluktuacija u raznolikosti i količini proizvoda. Nije dovoljno proizvoditi visoko kvalitetne proizvode po prihvatljivoj cijeni već je potrebno biti prilagodljiv prema hirovitim promjenama koje diktira tržište i to na ekonomičan način. Jedan od odgovora na takve zahtjeve je postavljanje odzivnih i troškovno učinkovitih proizvodnih sustava osiguranjem potrebne razine fleksibilnosti i autonomnosti kroz simultano upravljanje životnim ciklusom proizvoda i proizvodnim procesima. Rekonfigurabilni proizvodni sustav, kao nova paradigma, predstavlja model sustava koji omogućuje upravo takvu učinkovitost zbog mogućnosti podešavanja proizvodnih kapaciteta i funkcionalnosti. Važna značajka takvog modela je skalabilnost. Ona osigurava, za razliku od ostalih proizvodnih modela, preciznu prilagodbu proizvodnih kapaciteta čime se rješava problem vezan uz njihovo povećanje ili smanjenje na dinamičan način. Svrha ovog doktorskog rada je proširivanje spoznaja na području istraživanja upravo takvih proizvodnih sustava s naglaskom na skalabilnost i dinamičke implikacije koje uvjetuju brze promjene kapaciteta u proizvodnji. Analizirat će se i identificirati prednosti i nedostaci dosadašnjih spoznaja na području istraživanja proizvodnih sustava i mogućnosti prilagodbe takvih sustava novim tržišnim trendovima. Pokušat će se objediniti nove značajke koje pružaju rekonfigurabilni proizvodni sustavi, prvenstveno skalabilnost, u cilju izrade cjelovitog rješenja za projektiranje proizvodnih sustava. Osnovni cilj istraživanja je formiranje dinamičkog modela primjenom genetskog algoritma za projektiranje i izračun proizvodnih kapaciteta optimalnog višepredmetnog rekonfigurabilnog proizvodnog sustava za obradu grupe proizvoda.

Summary:

Today's production has to meet the challenges of extremely changeable market demands which are characterised by large fluctuations in the variety and quantity of products. It is not enough to produce high quality products at an affordable price, as it is necessary to be adaptable to sudden changes dictated by the market in an economical way. One of the answers to such demands is to set up responsive and cost-effective production systems in a way that ensures a certain level of flexibility and autonomy through simultaneous management of the product life cycle and production processes. Reconfigurable manufacturing systems, as a new paradigm, represent a system model that enables such efficiency as a result of the possibility of adjusting production capacity and functionality. An important feature of such a model is scalability. It provides, unlike other models, a precise adjustment of production capacity, which solves the problem of increasing or decreasing it in a dynamic way. The purpose of this doctoral thesis is to expand the knowledge in the field of research of such production systems, with an emphasis on scalability and the dynamic implications that cause rapid changes in production capacity. The strengths and weaknesses of current knowledge in the field of production systems research and the possibilities of adapting such systems to new market trends will be identified and analysed. Attempts will be made to integrate new features provided by reconfigurable production systems, primarily scalability, in order to create a complete solution for the design of production systems. The main goal of the research is to create a dynamic model by applying a genetic algorithm for designing and calculating the production capacity of an optimal multi-product reconfigurable production system for processing product families.



**IME I PREZIME | NAME AND SURNAME:**

Nikola Anđelić

**POLJE | SCIENTIFIC FIELD:**

Temeljne tehničke znanosti / Fundamental Engineering Sciences

**NAZIV RADA | TITLE:****Nanosenzor temeljen na grafenu za detekciju plinova**

Nanosensor based on graphene sheet for detection of gas molecules

**MENTORI | SUPERVISORS:**

prof. dr. sc. / Prof. D. Sc. Marko Čanadija

prof. dr. sc. / Prof. D. Sc. Zlatan Car

**DATUM OBRANE | DATE OF DEFENCE:**

12. 4. 2021.

**Sažetak:**

Nanosenzor za detekciju mase mehanički je senzor koji se s eksperimentalnog i teoretskog stajališta pokazao odličnim kandidatom u detekciji atoma i molekula. Osnovna ideja ovih senzora je metoda frekvencijskog pomaka. Ova metoda bazira se na razlici između vlastite frekvencije grafena sa i bez dodane mase u obliku vezanih atoma/molekula s ugljikovim atomima. Prije istraživanja vlastitih frekvencija jednog sloja grafena određene su mehaničke i termodinamičke karakteristike tog materijala primjenom MD-a s REBO međuatomskim potencijalom. Dobiveni mehanički i termodinamički parametri korišteni su u ne-lokalnoj teoriji tankih ploča s ciljem određivanja vlastitih frekvencija jednoslojnog grafena, kao i ispitivanja utjecaja temperature, tlaka, veličine jednoslojnog grafena, varijacije ne-lokalnog parametra na vlastite frekvencije i određivanje apsolutnog i relativnog frekvencijskog pomaka koje uzrokuju molekule plina pričvršćene za površinu jednoslojnog grafena. MD-a se koristila za određivanje vlastitih frekvencija jednoslojnog grafena, ispitivanje utjecaja veličine jednoslojnog grafena na vlastite frekvencije kao i apsolutnog i relativnog frekvencijskog pomaka kojeg uzrokuju pričvršćene molekule plina na centralni atom jednoslojnog grafena primjenom metode pobude brzine koristeći prethodno spomenuti međuatomski potencijal. Rezultati prethodno navedenih analiza u MD-u i ne-lokalnoj teoriji tankih ploča pokazali su da veličina jednoslojnog grafena ima najveći utjecaj na vlastite frekvencije jednoslojnog grafena, dok temperatura ima jako mali utjecaj na vlastite frekvencije. MD simulacije s NPT ansamblom pokazale su znatnu oscilaciju tlaku tijekom ekvibracije i simulacije vibracija, stoga je utjecaj tlaka izostavljen iz daljnjih analiza. Analize provedene primjenom ne-lokalne teorije tankih ploča također su pokazale da vrijednost ne-lokalnog parametra ima veliki

**Summary:**

A nanosensor for mass detection is a mechanical sensor that from an experimental and theoretical point of view has proven to be an excellent candidate in the detection of atoms and molecules. The basic idea of these sensors is the frequency shift method. This method is based on the difference between the resonant frequency of graphene with and without added mass in the form of atoms and molecules bonded with carbon atoms. Before investigating the natural frequencies of one layer of graphene, the mechanical and thermodynamic characteristics of this material were obtained using MD with REBO interatomic potential. The obtained mechanical and thermodynamic parameters were used in non-local thin plate theory to determine the natural frequencies of single-layer graphene, as well as to examine the influence of temperature, pressure, size of single-layer graphene, and a variation of a non-local graphene parameter on natural frequencies caused by gas molecules attached to the surface of the single-layer graphene. MD was used to determine the natural frequencies of single-layer graphene, to examine the influence of single-layer graphene size on natural frequencies, as well as the absolute and relative frequency shift caused by gas molecules attached to the central single-layer graphene atom, using the displacement excitation method. The results of the above analyses in MD and non-local thin plate theory showed that the size of single-layer graphene has the greatest influence on the natural frequencies of single-layer graphene, while temperature has a very small influence on the natural frequencies. MD simulations with an NPT ensemble showed that the pressure oscillates a lot during equilibration and vibration simulation, and therefore the influence of pressure was omitted from further analyses. Analyses performed using non-local thin plate theory also

utjecaj na vlastite frekvencije jednoslojnog grafena. Mehaničke karakteristike ovisne su o temperaturi i s porastom temperature vrijednost tih parametara se, uz male oscilacije, smanjuje. Za ispitivanje mogućnosti detekcije molekula plina primjenom ne-lokalne teorije i MD-a korišteni su fizikalni podatci 3 molekule kemijskog oružja za masovno uništenje. Obje teorije pokazale su da jednoslojni grafen može detektirati molekule plina primjenom metode apsolutnog i relativnog frekvencijskog pomaka. Jedan od glavnih nedostataka ne-lokalne teorije elastičnosti je nepoznata vrijednost ne-lokalnog parametra te se u mnogim istraživanjima njegova vrijednost postavlja u određenom rasponu. Stoga je cilj primijeniti algoritam genetskog programiranja u cilju dobivanja simboličkog izraza pomoću kojeg bi se mogla odrediti njegova vrijednost. Na temelju dobivenih parametara pomoću MD-a i ne-lokalne teorije, stvoren je skup podataka koji je korišten u algoritmu genetskog programiranja za određivanje jednadžbe pomoću koje bi se mogla odrediti vrijednost ne-lokalnog parametra. Dobivena jednadžba za određivanje ne-lokalnog parametra korištena je za određivanje apsolutnog i relativnog frekvencijskog pomaka koje uzrokuje masa pričvršćena u centru kompletno uklještenog grafena. Dobiveni rezultati uspoređeni su sa srednjim apsolutnim i relativnim frekvencijskim pomakom određeni pomoću MD simulacija. Rezultati usporedbe pokazali su da su u prosjeku izračunate vrijednosti apsolutnog i relativnog frekvencijskog pomaka 5 % manje od onih dobivenih pomoću MD simulacija.

showed that the value of the non-local parameter has a large influence on the natural frequencies of single-layer graphene. The mechanical characteristics are temperature dependent and with increasing temperature, the value of these parameters, with small oscillations, gradually decreases. The physical data of 3 molecules of chemical weapons of mass destruction were used to investigate the possibility of detecting gas molecules using non-local theory and MD. Both theories have shown that single-layer graphene can detect gas molecules using the absolute and relative frequency shift method. One of the main shortcomings of the non-local theory of elasticity is the unknown value of the non-local parameter, and in many studies its value is set in a certain range. Therefore, the goal is to apply a genetic programming algorithm to obtain a symbolic expression by which its value could be determined. Based on the obtained parameters using MD and non-local theory, a dataset was created which was used in the genetic programming algorithm to determine the equation by which the value of the non-local parameter could be determined. The obtained equation for determining the non-local parameter value was used to determine the absolute and relative frequency shift caused by the mass attached in the centre of the fully clamped graphene sheet. The obtained results were compared with the averaged absolute and relative frequency shift values obtained using MD simulations. The results of the comparison showed that on average the calculated values of absolute and relative frequency shift are 5% lower than those obtained using MD simulations.

**IME I PREZIME | NAME AND SURNAME:**

David Ištoković

**POLJE | SCIENTIFIC FIELD:**

Strojarstvo / Mechanical Engineering

**NAZIV RADA | TITLE:****Simulacijski okvir za određivanje optimalnoga vremenskog iskorištenja višepredmetnoga linijskoga proizvodnog sustava**

A simulation framework for determining the optimal time utilization of a hybrid flow shop

**MENTOR | SUPERVISOR:**

prof. dr. sc. / Prof. D. Sc. Mladen Perinić

**DATUM OBRANE | DATE OF DEFENCE:**

16. 4. 2021.

**Sažetak:**

Planiranjem proizvodnje osigurava se postojanje i konkurentnost proizvodnih poduzeća na tržištu. Osobito su važni poslovi operativne pripreme temeljem kojih se definira vremenski plan odvijanja proizvodnje i osiguravaju svi potrebni

**Summary:**

Production planning ensures existence and competitiveness on the market. The tasks of operational preparation, on the basis of which the production schedule is defined and all the necessary resources provided, are particularly



resursi. Kod proizvodnje tehnološki složenih obitelji proizvoda u modelu višepredmetnoga linijskoga proizvodnog sustava ograničene fleksibilnosti s proizvodnim procesom koji se odvija u više segmenata, uobičajena je visoka iskorištenost proizvodnog sustava što sužava mogućnost pronalaska ekonomičnog rješenja. Iz toga proizlazi potreba za razvojem simulacijskog okvira za određivanje veličine jedinične serije i redoslijeda ulaza jedinične serije u proizvodni proces, što su dva glavna područja poboljšanja mjera uspješnosti. Razlog razmatranja ovih dviju veličina leži u tome što različite vrijednosti veličine jedinične serije i redoslijeda ulaza proizvoda direktno utječu na vrijeme potrebno za odvijanje proizvodnog procesa. Rješavanje problema određivanja veličine jedinične serije i redoslijeda ulaza jedinične serije među najtežim je zadacima planiranja proizvodnje, pogotovo ako se posebna pozornost posveti utjecaju pripremno-završnog vremena ovisnog o slijedu i raspoloživosti proizvodnih kapaciteta i o dostupnosti transportne opreme na konačan rezultat. Implementiranjem izrađenog matematičkog modela u razvijeni simulacijski okvir stvorena je podloga za razvoj znanstveno zasnovane metode. Takav simulacijski okvir omogućava eksperimentiranje s računalnim matematičkim modelom fizikalnog sustava. Proizvodni proces prikazan je kao diskretna simulacija događaja podržana genetskim algoritmom. Primjenom i razvijanjem procedura unutar genetskog algoritma omogućeno je određivanje optimalnoga vremenskog iskorištenja višepredmetnoga linijskoga proizvodnog sustava. Razvijeni računalom potpomognuti simulacijski okvir provjeren je na konkretnom primjeru iz realnog sektora te na jednostavan i vizualno jasan način služi potpori pri planiranju proizvodnje. Simulacijski okvir primjenjiv je u raznim proizvodnim okruženjima, pogotovo onim koji se bave proizvodnjom širokog asortimana tehnološki složenih proizvoda.

**IME I PREZIME | NAME AND SURNAME:**

Marko Šrajbek

**POLJE | SCIENTIFIC FIELD:**

Interdisciplinarnе tehničke znanosti / Interdisciplinary Engineering Sciences

**NAZIV RADA | TITLE:**

Modeliranje širenja onečišćenja nitratima u podzemnoj vodi i analiza utjecaja na vodocrpilište

Nitrate pollution propagation in groundwater and wellfield impact assessment

**MENTORI | SUPERVISORS:**prof. dr. sc. / Prof. D. Sc. Lado Kranjčević  
izv. prof. dr. sc. / Assoc. Prof. D. Sc. Ivan Kovač**DATUM OBRANE | DATE OF DEFENCE:**

12. 7. 2021.

**Sažetak:**

U okviru ovog rada analizirani su određeni parametri kvalitete podzemne na vodocrpilištima Varaždin, Bartolovec i Vinokovščak u razdoblju od 1993. do 2017. godine. Podzemna voda je u pravilu dobre kvalitete, osim u pogledu koncentracije nitrata na vodocrpilištu Varaždin, gdje su vrijednosti tog parametra iznad maksimalno dopuštene koncentracije. Posljednjih godina povećava se količina crpljenja podzemne vode na vodocrpilištima Bartolovec i Vinokovščak, a u istom razdoblju uočeno je povećanje koncentracije nitrata, stoga je analizirana povezanost koncentracije nitrata o količini crpljenja. Uočena je dobra povezanost promatranih skupova podataka u gornjem, dok je povezanost izostala u donjem vodonosnom sloju. Analizirana je povezanost količine oborina i koncentracije nitrata na promatranim vodocrpilištima i uočena je dobra do jaka povezanost dvaju skupova podataka na gotovo svim promatranim lokacijama, a vrijednosti koeficijenta korelacije u pravilu su veće od 0,75. Na temelju izrađenih modela toka podzemne vode određena su utjecajna područja promatranih vodocrpilišta u radnim uvjetima te su locirani izvori onečišćenja nitratima, koji se općenito mogu podijeliti u površinske i točkaste izvore. S obzirom na vrijeme zadržavanja podzemne vode u horizontalnom toku, zaključuje se da su vodozaštitne zone sanitarne zaštite na sva tri promatrana vodocrpilišta obilježena u skladu s važećim pravilnikom. Prostorne distribucije koncentracije nitrata na promatranim vodocrpilištima dobivene Kriging metodom pokazuju povećanje koncentracije u nekom određenom smjeru, a na lokacijama vodocrpilišta Varaždin i Vinokovščak to povećanje je u smjeru točkastih izvora onečišćenja. Statističkim i geostatističkim metodama kvantificirani su izvori onečišćenja na vodocrpilištu Varaždin, a rezultati pokazuju da je odlagalište peradarskog materijala u utjecajnom području vodocrpilišta glavni izvor onečišćenja nitratima. Na temelju izrađenog modela toka podzemne vode na vodocrpilištu Varaždin provedena je simulacija transporta nitrata procesima advekcije i disperzije. Rezultati simulacije potvrđuju lokaciju odlagališta peradarskog materijala kao najveći izvor onečišćenja nitratima, međutim, značajan doprinos koncentraciji nitrata na vodocrpilištu pridonose i peradarske farme koje se nalaze u utjecajnom području vodocrpilišta.

**Summary:**

This paper analyses certain parameters of groundwater quality at wellfields in Varaždin, Bartolovec and Vinokovščak in the period from 1993 to 2017. The groundwater is generally of good quality, except in terms of nitrate concentration at the Varaždin wellfield, where the values of this parameter are above the maximum allowable concentration. In recent years, the pumping rate has been increasing at the wellfields of Bartolovec and Vinokovščak, and in the same period an increase in nitrate concentration has been observed. Therefore, the relationship between the nitrate concentration and pumping rate is analysed. A good correlation of the data sets is observed in the upper aquifer, while the correlation is absent in the lower aquifer. The correlation between precipitation and nitrate concentration at the observed wellfields is analysed and a good to strong correlation between the two data sets is observed at almost all locations, and the values of the correlation coefficient are generally higher than 0.75. Based on the developed groundwater flow models, the influential areas of the observed wellfields in working conditions are determined and the sources of nitrate pollution located. These can generally be divided into non-point and point sources. As far as the length of time of groundwater retention in the horizontal flow is concerned, it can be concluded that the water protection zones at all three observed wellfields are in accordance with the applicable ordinance. The spatial distributions of nitrate concentration at the observed wellfields obtained by the Kriging method show an increase in concentration in a particular direction, and at the locations of Varaždin and Vinokovščak wellfields the increase is in the direction of point sources of pollution. Statistical and geostatistical methods are used to quantify the sources of pollution at the Varaždin wellfield, and the results show that the poultry dumpsite in the influential area of the wellfield is the main source of nitrate pollution. Based on the developed groundwater flow models at the Varaždin wellfield, a simulation of nitrate transport by advection and dispersion processes is performed. The simulation results confirm the location of the poultry dumpsite as the largest source of nitrate pollution. However, poultry farms located in the area of influence of the wellfield also contribute significantly to the nitrate concentration there.

**IME I PREZIME | NAME AND SURNAME:**

Diego Sušanj

**POLJE | SCIENTIFIC FIELD:**

Računarstvo / Computer Science

**NAZIV RADA | TITLE:**

Model razmještaja osjetila za pokrivanje zatvorenoga prostora

Spatial sensor distribution model for indoor environment coverage

**MENTOR | SUPERVISOR:**

izv. prof. dr. sc. / Assoc. Prof. D. Sc. Kristijan Lenac

**DATUM OBRANE | DATE OF DEFENCE:**

24.8.2021.

**Sažetak:**

Mnoge primjene zahtijevaju postavljanje osjetila u prostoru. Primjerice, postavljanjem kamera u muzeje omogućuje se nadzor umjetnina i praćenje osoba u prostoru muzeja. U tom slučaju potrebno je odrediti pozicije i orijentacije kamera, a jedan od važnijih kriterija odabira često je pokrivenost prostora osjetilnim sposobnostima osjetila. Ova disertacija razmatra problem razmještaja zadanog broja i vrste osjetila u prostoru s ciljem što veće pokrivenosti zatvorenog prostora osjetilnim sposobnostima osjetila. Kako bi računalni program bio u mogućnosti odabrati i predložiti razmještaj osjetila, potrebno je modelirati promatrani prostor i korištena osjetila. U disertaciji je predložen generički model prostora sa sposobnošću procjene pokrivenosti te generički modeli osjetilnih sposobnosti svesmjernih i usmjerenih osjetila. Predložen je i model razmještaja osjetila u zatvorenom prostoru združivanjem predloženih modela prostora i modela osjetilnih sposobnosti osjetila. Provedeno je eksperimentalno istraživanje razmještaja različitog broja svesmjernih i usmjerenih osjetila u dvodimenzionalnim i trodimenzionalnim prostorima. Odabrano je i predloženo šest reprezentativnih stohastičkih optimizacijskih algoritama koji su uspoređeni s iscrpnim pretraživanjem. Tri odabrana algoritma spadaju u skupinu metaheurističkih iterativnih algoritama, dok druga tri pripadaju skupini metaheurističkih genetskih algoritama. Ispitani algoritmi ostvarili su značajno ubrzanje vremena izvođenja uz malu relativnu pogrešku pokrivenosti prostora u odnosu na pristup iscrpnog pretraživanja. Obilježja šest odabranih optimizacijskih algoritama analizirana su i međusobno uspoređena za problem razmještaja osjetila u zatvorenom prostoru. Eksperimentalna provjera pokazala je da algoritam umjetnog roja pčela ostvaruje najveću prosječnu pokrivenost prostora bez značajne razlike u vremenu izvođenja odabranih algoritama.

**Summary:**

Many applications require the placement of sensors in an environment. For example, the placement of cameras in museums enables the monitoring of artworks and people in the museum space. In this case, it is necessary to determine the positions and orientations of the cameras. When determining sensor placement, one of the more important selection criteria is often the coverage of the environment by the sensors. This dissertation investigates the sensor placement problem with the goal of maximising the sensor coverage of an indoor environment. In order for the computer program to be able to select and suggest sensor placement, it is necessary to model the observed environment and the sensors used. In this dissertation, a generic environment model with coverage estimation capability and generic models of sensing abilities for isotropic and directional sensors are proposed. A model of spatial sensor distribution in an indoor environment combining the proposed environment and sensor models is also proposed. An experimental study on the spatial distribution of different numbers of isotropic and directional sensors is conducted. The sensors are placed in two-dimensional and three-dimensional environments. Six selected stochastic optimisation algorithms are compared with an exhaustive search. The three selected algorithms belong to the group of metaheuristic iterative algorithms, while the other three belong to the group of metaheuristic genetic algorithms. Compared to the exhaustive search approach, the selected algorithms achieve significantly lower computation times with a small relative error in the environment coverage. The properties of the six selected optimisation algorithms are studied and compared for the indoor sensor placement problem. Experimental verification shows that among the six selected algorithms, the Artificial Bee Colony algorithm achieves the highest average coverage for all test cases, with no significant differences in the execution time of the selected algorithms.

**IME I PREZIME | NAME AND SURNAME:**

Luka Grbčić

**POLJE | SCIENTIFIC FIELD:**

Temeljne tehničke znanosti / Fundamental Engineering Sciences

**NAZIV RADA | TITLE:**

Numeričko modeliranje miješanja fluida u cjevovodnim mrežama uz primjenu strojnog učenja

Numerical modeling of fluid mixing in pipe networks with machine learning applications

**MENTOR | SUPERVISOR:**

prof. dr. sc. / Prof. D. Sc. Lado Kranjčević

**DATUM OBRANE | DATE OF DEFENCE:**

3. 9. 2021.

**Sažetak:**

Vodoopskrba je jedna od najvažnijih javnih usluga koja doprinosi kvaliteti života, a važnost sigurnog vodoopskrbnog sustava osnovni je zahtjev svake gradske vodovodne mreže. Pravilno modeliranje miješanja u hidrauličkim elementima mreže od velike je važnosti za točnu simulaciju i predikciju širenja onečišćenja. U ovoj doktorskoj disertaciji istražuje se miješanje fluida u cjevovodnim mrežama i njenim segmentima (dvostruki T-spojevi) eksperimentalnim pristupom, numeričkim modelima i metodama strojnog učenja u svrhu točnijeg i efikasnijeg modeliranja širenja i detekcije onečišćenja u urbanim vodoopskrbnim mrežama. Dobiveni su eksperimentalni podaci za miješanje fluida u različitim konfiguracijama dvostrukih T-spojeva te je validiran numerički model kalibracijom turbulentnog Schmidtoveg broja. Istražuje se i predlaže pristup baziran na strojnom učenju koji koristi Umjetne neuronske mreže (Artificial Neural Networks) i koji se trenira podacima koji su generirani rezultatima dobivenim putem numeričkih analiza u svrhu stvaranja računski učinkovitih modela za miješanje fluida u dvostrukim T-spojevima. Osim navedenog, istražuje se i modeliranje miješanja fluida u dvostrukom T-spoju putem modela turbulencije Large Eddy Simulation povezanom s modelom čistog advekcijanskog transporta skalara koji točno modelira miješanje bez uključivanja turbulentnog Schmidtoveg broja. Predstavljene su tri različite metodologije koje koriste algoritme strojnog učenja u svrhu otkrivanja izvora onečišćenja u vodovodnim mrežama. Prva od tri metodologije temelji se na klasifikaciji najvjerojatnijeg izvora onečišćenja u vodoopskrbnoj mreži i radi na temelju algoritma Nasumičnih šuma (Random Forest). Algoritam Nasumičnih šuma istreniran je podacima koji su dobiveni Monte Carlo simulacijama koje uključuju modeliranje transporta onečišćenja. Algoritam se pokazuje

**Summary:**

As water supply is one of the most recognisable and important public services contributing to the quality of life, the importance of a safe water supply system is a basic requirement for every urban water distribution network. The correct treatment of mixing phenomena in the network's hydraulic elements is of great importance for the accurate simulation and prediction of contamination events. In this doctoral thesis, the mixing of fluids in pipe networks and segments (double-Tee junctions) is investigated using an experimental approach, numerical models and machine learning methods. Firstly, experimental data are obtained for fluid mixing in different double-Tee configurations, and a computational fluid dynamics transport model is calibrated and validated through setting the turbulent Schmidt number. A machine learning approach which uses Artificial Neural Networks is then proposed and trained with numerically generated data for the purpose of creating computationally efficient models for fluid mixing in double-Tee junctions. Additionally, a Large Eddy Simulation model coupled with a pure advection transport model is investigated and shown to produce accurate fluid mixing results in a double-Tee junction, therefore showing a way of not including the turbulent Schmidt number. Secondly, three methodologies are presented which use machine learning algorithms for the purpose of contamination source detection in water supply pipe networks. The first methodology is based on a Random Forest algorithm classification of the most probable contamination source in a water supply network. The RF classifier is trained with data obtained by Monte Carlo water quality simulations and is shown to be computationally efficient and can easily generate a list of the most probable contamination sources in a water supply network. In addition, a novel machine learning based algorithm for water



računalno učinkovitim i lako generira popis najvjerojatnijih izvora onečišćenja. Nadalje, predstavljena je druga metodologija koja koristi algoritam zasnovan na strojnom učenju za klasifikaciju izvora onečišćenja u vodoopskrbnim mrežama, izrađen posebno za paralelne sustave visokih performansi. Algoritam koristi kombinaciju Umjetnih neuronskih mreža (Artificial Neural Networks) za klasifikaciju izvora onečišćenja i algoritam Nasumičnih šuma za regresijsku analizu, kako bi odredio značajne varijable događaja onečišćenja kao što su vrijeme početka onečišćenja, vrijeme završetka onečišćenja i koncentraciju onečišćenja. Na kraju, trećom metodologijom predstavljena su i istražena dva nova algoritamska okvira koja se temelje na spajanju algoritma strojnog učenja za predviđanje najvjerojatnijih izvora onečišćenja s optimizacijskim algoritmima za određivanje značajnih varijabli onečišćenja u vodovodnoj mreži.

supply contamination source identification is presented and built for high performance parallel systems. The algorithm successfully utilises the combination of Artificial Neural Networks for a parallel tournament style classification of the contamination source with Random Forests for regression analysis to determine significant variables of a contamination event. Lastly, two novel algorithmic frameworks are investigated which are based on coupling a machine learning algorithm for predicting the most probable contamination sources in a water distribution network with an optimisation algorithm for determining the relevant parameters, such as contamination start time, end time and contaminant concentration for each predicted node. Both algorithmic frameworks perform well in determining the true source node, start and end times and contaminant concentration.

podataka. Metoda analize omeđivanja podataka je neparametarska metoda koja se temelji na linearnom programiranju i u mjerenju koristi inpute i outpute iz procesa koji se promatra, svim promatranim brodovima pridružuje iznose efikasnosti, izdvaja primjere najbolje tehničke prakse te od njih daje uzore za neefikasne brodove, kao i iznose relativnih i apsolutnih poboljšanja za neefikasne brodove. Promatrani skup obuhvaća pet vrsta brodova, ukupno njih trideset i četiri, dokovanih u pet različitim remontnih brodogradilišta u zemlji i inozemstvu. U razmatranju inputa uzeti su podaci o bruto tonaži, opsegu radova na čeliku i bojenju i relativna brojnost posade, dok u outpute spadaju troškovi najma doka, usluga i energije iz doka, troškovi procesa bojenja, troškovi posade i troškovi transfera broda i kašnjenja u razdoblju dokovanja. Za analizu efikasnosti i pronalaženje slučajeva najbolje tehničke prakse korišteno je ukupno pet modela metode analize omeđivanja podataka. U ovom radu prikazani su rezultati mjerenja efikasnosti i ovisnost iznosa efikasnosti o sezoni dokovanja, trajanju dokovanja i stvorenim troškovima poduhvata.

Data Envelopment Analysis methodology has been utilised in order to measure newbuilding dry-docking relative efficiency. Data Envelopment Analysis is a non-parametric method based on Linear Programming, using inputs and outputs derived from the researched process, giving an efficiency amount to all the vessels, and sorting out the benchmark vessels, which become the peers for the inefficient vessels. The improvement needed for the inefficient vessels is presented in absolute and relative values. The researched vessel set consists of five vessel types and thirty-four vessels in total. The vessels in this research were dry-docked in five domestic and foreign repair shipyards. The inputs consist of data related to gross tonnage, steelwork and coating work, as well as the relative crew number. The outputs comprise dry-dock rent and services cost, steelwork cost, coating cost, vessel transfer and delays costs. The dry-docking efficiency analysis and dry-docking benchmarking were carried out using five Data Envelopment Analysis models. The efficiency measurement results related to the dry-docking season, dry-docking duration and total cost are presented in this thesis.

**IME I PREZIME | NAME AND SURNAME:**

Denis Rabar

**POLJE | SCIENTIFIC FIELD:**

Strojarstvo / Mechanical Engineering

**NAZIV RADA | TITLE:**

Višekriterijski model za mjerenje usporedne efikasnosti dokovanja broda u gradnji

Multicriteria model for relative efficiency measurement of the newbuilding drydocking

**MENTOR | SUPERVISOR:**

prof. dr. sc. / Prof. D. Sc. Duško Pavletić

doc. dr. sc. / Assist. Prof. D. Sc. Sandro Doboviček

**DATUM OBRANE | DATE OF DEFENCE:**

3. 9. 2021.

**Sažetak:**

Dokovanje broda u gradnji dio je brodograđevnog procesa, poduzima se u samoj završnici gradnje broda te čini organizaciju poslova u doku, osposobljavanje broda za prvu samostalnu plovidbu i osiguravanje uvjeta za život i rad osoblja koje se na brod ukrcava u svojstvu posade i učesnika dokovanja kompleksnim zadatkom. Uz kompleksnost u tehničkom smislu, dokovanje je potrebno obaviti u najkraćem mogućem roku i uz optimalni trošak i kvalitetu, što će omogućiti brodu da u narednih pet godina službuje bez dokovanja. Dokovanje se koristi i kao razdoblje u kojem je moguće nadoknaditi zaostatke u prethodno započetim radovima na brodu. Za opis dokovanja koristi se procesni pristup gdje se inputi pretvaraju u outpute procesa. Za potrebe mjerenja usporedne efikasnosti dokovanja brodova u gradnji postavljen je višekriterijski model koji koristi metodu analize omeđivanja

**Summary:**

Newbuilding dry-docking is part of the shipbuilding process which is carried out with the completion of the newbuilding vessel, and represents a complex assignment in many respects, as it involves dry-docking activity organisation, the establishment of living and working conditions for the enlisted crew and making the vessel seaworthy for its first voyage. Besides the technical complexity of the activities, the dry-docking needs to be completed in the shortest possible time period, with optimal cost and quality, thus making the vessel ready for the next five-year service period without subsequent dry-docking. The dry-docking period could also be used as a period for the completion of delayed works on board the vessel. A process approach is used in the dry-docking process description, using process inputs which are then transformed into process outputs. A multi-criteria model using



## 2.7 AKTIVNI PROJEKTI

### ACTIVE PROJECTS

#### 2.7.1 HRZZ PROJEKTI

##### HRZZ PROJECTS



###### NAZIV PROJEKTA | PROJECT TITLE:

###### Razvoj modela za procjenu ponašanja materijala temeljenih na strojnom učenju - MADEIRA

Development of machine learning-based models for materials behavior estimation - MADEIRA

###### Glavni istraživač

prof. dr. sc. Robert Basan,  
Sveučilište u Rijeci, Tehnički fakultet

###### Članovi istraživačkog tima

izv. prof. dr. sc. Dario Iljkić,  
Sveučilište u Rijeci, Tehnički fakultet  
doc. dr. sc. Tea Marohnić,  
Sveučilište u Rijeci, Tehnički fakultet  
doc. dr. sc. Sunčana Smokvina Hanza,  
Sveučilište u Rijeci, Tehnički fakultet  
doc. dr. sc. Jelena Srnec Novak,  
Sveučilište u Rijeci, Tehnički fakultet  
doc. dr. sc. Andrej Žerovnik,  
Fakulteta za strojništvo, Univerza v Ljubljani,  
Ljubljana, Slovenija  
asist. Lovro Štic,  
Sveučilište u Rijeci, Tehnički fakultet

###### Sažetak projekta

Modeliranje ponašanja materijala ključan je dio suvremenog razvoja proizvoda i računalnih simulacija koje se provode radi čim bolje iskoristavanja materijala i smanjenja mase i troškova. Za uspješno modeliranje ponašanja materijala nužno je poznavanje njegovih značajki i parametara ponašanja. Njihovo eksperimentalno određivanje je najtočnije, ali je dugotrajno i skupo te se stoga nastoji izvoditi u najmanjoj mogućoj mjeri. Projektom MADEIRA cilja se na rješavanje nedostatka podataka o ponašanju materijala potrebnih za numeričke proračune i simulacije koji otežavaju šire prihvaćanje modeliranja materijala te uključuju napredne materijalne modele u suvremeni proces razvoja proizvoda. Predloženo istraživanje usmjereno je razvoju modela za procjenu ponašanja i parametara materijala temeljenih na strojnom učenju kao rješenju navedenih problema. Na osnovi prikupljenih rezultata istraživanja materijala i rezultata provedenih eksperimenata, sustavno će se istražiti, identificirati i mapirati

###### Principal investigator

Prof. Robert Basan, D. Sc.,  
Faculty of Engineering, University of Rijeka

###### Members of the research team

Assoc. Prof. Dario Iljkić, D. Sc.,  
Faculty of Engineering, University of Rijeka  
Assist. Prof. Tea Marohnić, D. Sc.,  
Faculty of Engineering, University of Rijeka  
Assist. Prof. Sunčana Smokvina Hanza, D. Sc.,  
Faculty of Engineering, University of Rijeka  
Assist. Prof. Jelena Srnec Novak, D. Sc.,  
Faculty of Engineering, University of Rijeka  
Assist. Prof. Andrej Žerovnik, D. Sc.,  
University in Ljubljana, Faculty of Mechanical  
Engineering, Ljubljana, Slovenia  
Assist. Lovro Štic,  
Faculty of Engineering, University of Rijeka

###### Project summary

Materials modelling is a key part of modern product development and computer simulations performed to improve materials utilisation and reduce weight and costs. The main prerequisite for successful materials modelling is knowledge of their behaviour and properties. Its experimental determination is very accurate, but it is time-consuming and expensive, and there is a trend to perform as few experiments as possible. The MADEIRA project addresses the lack of materials data and behaviour parameters needed for numerical simulations, which is one of the major obstacles to the wider use of advanced materials models in the industry. The proposed research aims at the development of advanced machine-learning-based models for the estimation of materials behaviour and related parameters as a solution for the above problems. Based on the results of materials research and data collected from published sources and the results of our own experiments, the complex relationships between the properties and behaviour of materials will

kompleksni odnosi između svojstava/značajki materijala, njihovog mehaničkog ponašanja i pripadnih parametara na različitim razinama. Unaprijedit će se postojeći i razviti novi modeli procjene naprednih monotonih, cikličkih i zamornih parametara materijala te matematički modeli termalnih postupaka prerade metala i modeliranja njihovih mehaničkih svojstava nakon toplinske obrade. Istražit će se primjenjivost raznih metoda strojnog učenja te mogućnosti procjene parametara i naprednih konstitutivnih materijalnih modela koji se, zbog kompleksnosti i velikog broja potrebnih parametara, otežano i rijetko primjenjuju u praksi. Razvijene baze podataka i prediktivni modeli trebali bi doprinijeti široj primjeni modeliranja ponašanja materijala i računalnih simulacija, a uspostavljen metodološki okvir i principi primjene strojnog učenja mogli bi biti korisni i primjenjivi za razvoj prediktivnih modela i u drugim područjima primjene i istraživanja materijala.

###### NAZIV PROJEKTA | PROJECT TITLE:

###### Nelokalni mehanički modeli nanogreda - nonNano

Nonlocal mechanical models of nanobeams - nonNano

###### Glavni istraživač

prof. dr. sc. Marko Čanadija,  
Tehnički fakultet, Sveučilište u Rijeci

###### Članovi istraživačkog tima

izv. prof. dr. sc. Marino Brčić,  
Tehnički fakultet, Sveučilište u Rijeci  
doc. dr. sc. Stefan Ivić,  
Tehnički fakultet, Sveučilište u Rijeci  
doc. dr. sc. Ante Skoblar,  
Tehnički fakultet, Sveučilište u Rijeci  
pred. dr. sc. Neven Munjas,  
Istarsko veleučilište, Hrvatska  
dr. sc. Nikola Anđelić, postdoktorand,  
Tehnički fakultet, Sveučilište u Rijeci  
asist. Valentina Košmerl,  
Tehnički fakultet, Sveučilište u Rijeci  
asist. Martin Zlatić,  
Tehnički fakultet, Sveučilište u Rijeci

###### Sažetak projekta

Istraživanjem će se razviti napredni nelokalni modeli nanogreda, prikladni za provođenje realističnih simulacija mehaničkog ponašanja nanostrukture. Naime, velika većina rezultata predstavljenih u literaturi uključuje određene manjkavosti. U tom smislu valja istaći dva problema. Često korištena nelokalna gredna

be systematically analysed, identified and mapped at different levels. Existing models for the estimation of advanced monotonic, cyclic and fatigue parameters will be improved and new ones developed. Mathematical models of the thermal processes of metals and the prediction of their mechanical properties after heat treatment will be further improved. The applicability of different machine-learning-based methods for the estimation of the parameters of advanced constitutive material models will also be investigated. Due to the large number of required materials parameters, these are rarely applied in industrial practice. The database and predictive models developed should contribute to the wider application of materials behaviour modelling and computer simulations, and the established methodological framework and principles of machine learning may be useful and applicable in the development of predictive models in other fields of materials research and application.

###### Principal investigator

Prof. Marko Čanadija, D. Sc.,  
Faculty of Engineering, University of Rijeka

###### Members of the research team

Assoc. Prof. Marino Brčić, D. Sc.,  
Faculty of Engineering, University of Rijeka  
Assist. Prof. Stefan Ivić, D. Sc.,  
Faculty of Engineering, University of Rijeka  
Assist. Prof. Ante Skoblar, D. Sc.,  
Faculty of Engineering, University of Rijeka  
Lecturer Neven Munjas, D. Sc.,  
Istrian University of Applied Sciences  
Nikola Anđelić, D. Sc., postdoc,  
Faculty of Engineering, University of Rijeka  
Assist. Valentina Košmerl,  
Faculty of Engineering, University of Rijeka  
Assist. Martin Zlatić,  
Faculty of Engineering, University of Rijeka

###### Project summary

The project aims to develop advanced non-local nanobeam models suitable for a more realistic simulation of the mechanical behaviour of nanostructures. The motivation for this research arises from several shortcomings in the majority of the results presented in the literature. Two of these should be pointed out. The widely used



formulacija temeljena na gradijentnim metodama daje paradoksalne rezultate u nekim osnovnim problemima. Drugi je problem povezan s mehaničkim značajkama koje su potrebne radi dobivanja rezultata usporedivih s eksperimentima, odnosno simulacijama provedenim pomoću molekularne dinamike. Pritom se kao najvažnija mehanička značajka može istaći nelokalni parametar. Točna vrijednost nelokalnog parametra za pojedine materijale uključuje mnoštvo nesigurnosti. Da bi se nadišlo gore opisane paradokse, koristit će se integracijska formulacija temeljena na naprezanjima. Ovo je novi i obećavajući pristup koji nema spomenute poteškoće. Što se pak tiče realističnog mehaničkog ponašanja, da bi se postigao takav cilj mora se uzeti u obzir i diskretnu prirodu nanostrukture. U tom smislu, izotermni procesi deformiranja nanogreda predstavljat će ishodišnu točku, no fokus će biti na neizotermičkim problemima. U prvom redu, u tom kontekstu razmatrat će se važna proširenja na dinamičko ponašanje, kao i na kompozitne nanogrede. Razvijene formulacije bit će iskorištene za razvoj novog nelokalnog grednog konačnog elementa koji će biti ugrađen u softver za analizu konačnim elementima Simulia/Abaqus. Novi konačni element omogućit će provođenje niza simulacija s ciljem dobivanja topološki optimalnih struktura s ciljanim značajkama.

Projekt financira Hrvatska zaklada za znanost.

#### NAZIV PROJEKTA | PROJECT TITLE:

##### Modeliranje i simulacija u razvoju naprednih materijala - SIMMAT

Modelling and simulation in advanced materials development - SIMMAT

#### Glavni istraživač

prof. dr. sc. Marina Franulović,  
Tehnički fakultet, Sveučilište u Rijeci

#### Članovi istraživačkog tima

prof. dr. sc. Dražan Kozak,  
Strojarski fakultet u Slavonskom Brodu,  
Sveučilište u Slavonskom Brodu

doc. dr. sc. Kristina Marković,  
Tehnički fakultet, Sveučilište u Rijeci

asist. Matej Gljuščić,  
Tehnički fakultet, Sveučilište u Rijeci

asist. David Liović,  
Tehnički fakultet, Sveučilište u Rijeci

asist. Maja Dundović,  
Tehnički fakultet, Sveučilište u Rijeci

gradient-based non-local beam formulations are prone to paradoxical results if applied to certain basic bending problems. The other problem is related to the mechanical properties that are needed in order to obtain similar results like those obtained experimentally or by molecular dynamic simulations. The most important mechanical property is the non-local parameter, but its precise value for a certain material still encompasses a lot of uncertainties. In order to overcome the mentioned paradoxes, the stress-driven integral formulation will be used. This is a novel and promising approach, not suffering from the above-described problems. As far as realistic mechanical behaviour is concerned, in order to reach such a goal, the discrete nature of nanostructures must be accounted for. Although the isothermal deformation of nanobeams will be the starting point, the focus will be on non-isothermal processes. In particular, these will include important extensions to dynamic effects and also composite materials. The formulations obtained in such a manner will be used to develop a novel non-local beam finite element that will be incorporated into the finite element software Simulia/Abaqus. With the new finite element, a series of simulations will be performed in order to obtain topologically optimal structures with tailored properties.

The project is supported by the Croatian Science Foundation.

#### Principal investigator

Prof. Marina Franulović, D. Sc.,  
Faculty of Engineering, University of Rijeka

#### Members of the research team

Prof. Dražan Kozak, D. Sc.,  
Mechanical Engineering Faculty, University of  
Slavonski Brod

Assist. Prof. Kristina Marković, D. Sc.,  
Faculty of Engineering, University of Rijeka

Assist. Matej Gljuščić,  
Faculty of Engineering, University of Rijeka

Assist. David Liović,  
Faculty of Engineering, University of Rijeka

Assist. Maja Dundović,  
Faculty of Engineering, University of Rijeka

#### Sažetak projekta

Visoka razina tržišnog natjecanja postavlja putokaze za razvoj novih tehnologija u dizajnu strojarskih konstrukcija i predstavlja značajne izazove konstruktorima. Istraživanje u okviru projekta predstavlja nastavak prethodnih istraživanja tako da se razvijena metodologija, efikasna za metalne i biološke materijale, prilagodi i primijeni na karakterizaciju, simulaciju i analizu ponašanja i usvajanje potrebnih znanja o materijalima dobivenim aditivnim tehnologijama. Stoga je u projektu predviđeno utvrđivanje i provedba postupka karakterizacije kompozitnih materijala i titanijevih legura izrađenih aditivnim tehnologijama i validacija rezultata metodom fotoelastometrije na stvarnim strojnim dijelovima. Očekuje se znanstveni doprinos kroz rezultate koji će omogućiti procjenu životnog vijeka konstrukcija izrađenih od spomenutih materijala primjenom aditivnih tehnologija.

#### Projektne aktivnosti tijekom prve godine provedbe projekta rezultirale su sljedećim:

provedena je detaljna analiza dostupnih podataka i izvora informacija koji pokrivaju područje interesa, sintetizirana kroz izvješća. Slijede kratki zaključci za tri promatrane skupine materijala:

1. kompoziti (zabilježen je manjak znanstvenih radova identifikacije mehaničkih svojstava aditivno proizvedenih kompozitnih struktura kroz opterećenje i rasterećenje ispitnih uzoraka što je onemogućilo donošenje zaključaka o zonama elastičnosti, plastičnosti i raspona deformacija oko kojih se očekuju najveća oštećenja pa je prema tom cilju usmjereno i tekuće istraživanje. Nadalje, koristeći optičke metode, opravdana je akvizicija vrijednosti pomaka kompletne površine ispitnih uzoraka. Sintezom prikupljenih podataka utvrđena je potreba promatranja dvoosne rezultirajuće deformacije i informacije o promjeni vrijednosti Poissonovog koeficijenta s obzirom na tijek opterećenja i rasterećenja);
2. titanijeve legure (izbor komercijalno dostupnih titanijevih legura u praškastom stanju je prilično ograničen, a sistematično istraživanje statičkih i dinamičkih mehaničkih svojstava Ti-xCu legura izrađenih selektivnim laserskim taljenjem nije u dovoljnoj mjeri provedeno, odnosno rezultati nisu javno objavljeni. Ipak, njihove mehaničke karakteristike su ključne za definiranje mogućnosti i okvira primjene ovakvih naprednih titanijevih legura dobivenih aditivnim tehnologijama. Unatoč značajnoj razlici u apsorpciji energije pri taljenju titanijske i bakra, utvrđena je mogućnost izrada Ti-5Cu i Ti6Al4V - xCu legura uz pravilan izbor SLM procesnih parametara. Utvrđeno je postojanje ovisnosti mehaničkih svojstava o orijentaciji ispitnih

#### Project summary

The high level of competitiveness on the market today has increased the importance of the development of new technologies in the design of mechanical structures, and represents significant challenges for mechanical engineers. This research considers the adaptation of the previously obtained results of the material behaviour of metals and biomaterials to the characterisation, simulation and behaviour analysis of materials produced by additive technologies. The project provides for the determination and implementation of the characterisation process of composite materials and titanium alloys produced by additive technologies, as well as the validation of results by photoelasticity on real machine parts. The research results are expected to provide the opportunity to evaluate and predict the lifespan of constructions made from the observed materials during their exploitation.

#### Results of project activities in the first year

A thorough analysis of available data and information sources, which cover the foundations of the observed areas, was conducted and reported on. The analysis was conducted in three directions with brief conclusions:

1. Composites (so far, there has been a lack of scientific work on the identification of the mechanical properties of additively produced composite structures through the loading and unloading of test specimens, which has prevented conclusions about the zones of the elasticity, plasticity and deformation range around which the greatest damage is expected. Using optical methods, it is planned to acquire data on displacements on the test specimen surfaces and to present the resulting deformations and information on the change in the value of Poisson's ratio with respect to the loading conditions).
2. Titanium alloys (the choice of commercially available titanium alloys in powder form is still very limited. Systematic investigations of the static and dynamic mechanical properties of Ti - xCu alloys produced by selective laser melting have not yet been conducted or been made publicly available. Systematic investigations of mechanical properties are crucial for defining the potential field of application of these advanced additive titanium alloys. Despite the significant difference in the absorption energy of laser radiation and the thermal conductivity of titanium and copper, it was found that it is still possible to produce Ti-5Cu and Ti6Al4V - xCu alloys through a proper choice of SLM process parameters. The mechanical properties of metallic materials are certainly influenced by the orientation of the test



uzoraka pri proizvodnji, procesnim parametrima i toplinskoj obradi);

3. fotoelastični materijali (eksperimentalna istraživanja fotoelastičnih modela proizvedenih aditivnim tehnologijama su opravdana, s obzirom na nedostatak objavljenih rezultata o njihovom odzivu pri opterećenju. Ovdje se promatraju fotopolimeri za koje se očekuje da imaju dobra optička i mehanička svojstva osigurana primjenom DLP (Digital Light Processing) aditivne proizvodne tehnologije. Osnovne karakteristike odabrane tehnologije su: preciznost, brzina polimerizacije, posebnost teksture površine te, u slučaju nekompletne polimerizacije, anizotropnost uzoraka zbog pikselizacije projicirane slike, dimenzijskih nepravilnosti i zaostalim naprezanjima koja se pojavljuju prilikom odvajanja sloja).

#### NAZIV PROJEKTA | PROJECT TITLE:

##### **Autonomni sustav bespilotnih letjelica za traženje i spašavanje na moru - AOSeR**

Autonomous UAV system for oceanic search and rescue - AOSeR

#### Glavni istraživač

doc. dr. sc. Stefan Ivić,  
Tehnički fakultet, Sveučilište u Rijeci

#### Članovi istraživačkog tima

asist. dr. sc. Luka Grbčić,  
Tehnički fakultet, Sveučilište u Rijeci  
Ante Sikirica, doktorand,  
Centar za napredno računanje i modeliranje,  
Sveučilište u Rijeci

#### Sažetak projekta

Korištenje bespilotnih letjelica (UAV) u misijama pretraživanja ima brojne prednosti, uključujući manevrabilnost, smanjenje ljudskog rizika i ekonomičnost. Primjena algoritama pretraživanja osigurava prostor za razvoj i korištenje najsuvremenijih metoda koje uvelike mogu povećati performanse pretraživanja. Pri traženju nestacionarnog cilja, poput osobe koja pluta u moru, razmatranje njegove dinamike kretanja presudno je za uspjeh pretraživanja. Predlažemo da se ispita primjenjivost nove metode pokrivanja područja i sustava detekcije i osjetila na problem pretraživanja u oceanskim okruženjima. Za metodu pokrivanja područja namjeravamo upotrijebiti HEDAC (pokrivanje područja pogonom toplinske jednadžbe) koja se pokazala kao jedan od najnaprednijih algoritama za heterogenu kontrolu više agenata u stacionarnim uvjetima. HEDAC bi trebao omogućiti pretraživanje nestacionarne distribucije meta s upotrebom više agenata.

sample, scanning strategy and heat treatment).

3. Photoelastic materials (experimental tests on photoelastic models produced by additive technologies are justified, given that no test results have been found in the literature on models produced by this technology. It uses photopolymers that are expected to have good optical and mechanical properties combined with selected DLP (Digital Light Processing) additive production technology. The main characteristics of the selected "bottom-up" DLP technology are precision, speed through polymerisation of the entire layer at once, specific surface roughness and, in the case of incomplete polymerisation, anisotropy of products caused by the pixelation of projected photography, dimensional irregularities caused by the necessary supports, and residual stresses that occur during the detachment of the layer from the vessel.)

#### Principal investigator

Assist. Prof. Stefan Ivić, D. Sc.,  
Faculty of Engineering, University of Rijeka

#### Members of the research team

Assist. Luka Grbčić, D. Sc.,  
Faculty of Engineering, University of Rijeka  
Ante Sikirica, PhD student,  
Center for Advanced Computing and Modelling,  
University of Rijeka

#### Project summary

The utilisation of Unmanned Aerial Vehicles (UAVs) in search missions has many advantages, including manoeuvrability, human risk reduction and cost effectiveness. The application of search algorithms provides a space in which to develop and use state-of-the-art methods which can greatly increase the performance of a search. When searching for a non-stationary target, such as a person floating in the sea, the consideration of movement dynamics is critical to search success. We propose to test the applicability of a novel area coverage method and target detection and sensing system to the problem of searching in oceanic environments. For the area coverage method, we intend to use the HEDAC (Heat Equation Driven Area Coverage) method, which has shown to be one of the most advanced algorithms for heterogeneous multi-agent control in steady conditions. HEDAC should allow a search for an unsteady target distribution with the use of multiple agents. We plan to use multiple

Planiramo koristiti više UAV-ova s heterogenom senzorskom opremom i parametrima leta. To će biti UAV-ovi s rotacijskim krilima, opremljeni kamerama vizualnog i infracrvenog spektra. Vizualno otkrivanje i robusno praćenje ciljeva može se postići korištenjem nadziranih ili polunadziranih dubokih konvolucijskih i ponavljajućih neuronskih mreža. Predložena istraživanja uključuju dvije vrste eksperimenata. Prvi bi eksperiment bio osnovni scenarij pretraživanja sa stacionarnim ciljevima. U drugom, kojim je izvedivo pretraživanje na moru, UAV će morati samostalno detektirati plutajuće ciljeve, prateći tako ažuriranu pokrivenost cilja u stvarnom vremenu. Brzina morske površine kontinuirano će se mjeriti pomoću raspršenih plutača s GPS-om, koje će se koristiti za hranjenje sustava predviđanja strujanja mora baziranog na strojnom učenju. Budući da se konvencionalno pretraživanje oslanja na pretpostavke stalne i ujednačene raspodjele ciljeva, predloženi postupak trebao bi predstavljati značajno poboljšanje metodologije pretraživanja.

Projekt financira Hrvatska zaklada za znanost.

#### NAZIV PROJEKTA | PROJECT TITLE:

##### **Procjena granične nosivosti inženjerskih konstrukcija - LOCAPES**

Estimation of Limit Load Capacity of Engineering Structures - LOCAPES

#### Glavni istraživač

prof. dr. sc. Domagoj Lanc,  
Tehnički fakultet, Sveučilište u Rijeci

#### Članovi istraživačkog tima

prof. dr. sc. Goran Turkalj,  
Tehnički fakultet, Sveučilište u Rijeci  
prof. dr. sc. Josip Brnić, Prof. Emeritus,  
Tehnički fakultet, Sveučilište u Rijeci  
doc. dr. sc. Igor Pešić,  
Odsjek za politehniku, Sveučilište u Rijeci  
doc. dr. sc. Sanjin Krščanski,  
Tehnički fakultet, Sveučilište u Rijeci  
asist. Damjan Banić,  
Tehnički fakultet, Sveučilište u Rijeci  
asist. Sandra Kvaternik Simonetti,  
Tehnički fakultet, Sveučilište u Rijeci

#### Sažetak projekta

Nove tendencije u konstruiranju, za razliku od konvencionalnih pristupa, zahtijevaju permanentno proširivanje horizonata tehničkih znanja i adekvatan razvoj novih naprednih algoritama procudbe. Uz eksperimentalna

UAVs with heterogeneous sensing equipment and flight parameters. These will be rotary-wing UAVs equipped with visual and infrared spectrum cameras. Visual detection and robust tracking of targets can be accomplished by making use of supervised or semi-supervised deep convolutional and recurrent neural networks. The proposed research comprises two types of experiment. The first experiment would be a ground search scenario with stationary targets. In a second experiment, which is a feasible search at sea scenario, UAVs will need to detect floating targets autonomously, while following the real-time updated goal area coverage. Sea surface velocity will be continuously measured by use of scattered floating GPS-enabled buoys, which will be used to feed a machine learning sea flow predictor system. Since a conventional search relies on the presumptions of steady and uniform distribution of targets, the proposed procedure should represent a significant improvement in search methodology.

The project is supported by the Croatian Science Foundation.

#### Principal investigator

Prof. Domagoj Lanc, D. Sc.,  
Faculty of Engineering, University of Rijeka

#### Members of the research team

Prof. Goran Turkalj, D. Sc.,  
Faculty of Engineering, University of Rijeka  
Prof. Josip Brnić, D. Sc., Prof. Emeritus,  
Faculty of Engineering, University of Rijeka  
Assist. Prof. Igor Pešić, D. Sc.,  
Department of Polytechnics, University of Rijeka  
Assist. Prof. Sanjin Krščanski, D. Sc.,  
Faculty of Engineering, University of Rijeka  
Assist. Damjan Banić,  
Faculty of Engineering, University of Rijeka  
Assist. Sandra Kvaternik Simonetti,  
Faculty of Engineering, University of Rijeka

#### Project summary

New trends in design, unlike conventional approaches, require the permanent expansion of technical knowledge horizons and the development of new advanced estimation algorithms. In addition to experimental testing,



ispitivanja, kao zasigurno najpouzdaniji i najučinkovitiji pristup, numeričke se simulacije, zbog znatno nižih troškova, nameću kao nužnost. Kako je u fazi projektiranja konstrukcije od krucijalne važnosti pravilan izbor materijala, eksperimentalna identifikacija materijalnih značajki iznimno je bitna. Za određeni broj konvencionalnih materijala mehanički su parametri dostupni u literaturi no pojava novih, inovativnih materijala, zahtijeva i njihovo eksperimentalno utvrđivanje pa je doprinos ovoga projekta djelomično zamišljen i s tim ciljem. Eksperimentalna istraživanja parametara materijala i njegova ponašanja, posebice u specifičnim uvjetima, od iznimne su važnosti za uporabu materijala u odgovarajućim uvjetima eksploatacije.

Znatan će dio istraživanja biti posvećen razvoju novih i nadogradnji postojećih numeričkih simulatora za analizu prostornih grednih konstrukcija, s posebnim naglaskom na tankostijene gredne konstrukcije izvedene od novih, naprednih materijala kompozitnog tipa, kao npr. laminati, FG materijali i drugi, a u režimima ekstremnih uvjeta, npr. povišenih i sniženih temperatura i vlažnosti. Cilj simulacija bit će procijeniti moć nošenja konstrukcije, odnosno predvidjeti pojavu graničnog stanja s osvrtnom na razloge nastupanja kolapsa. Kao potpora cjelovitom modelu prosudbe, kako u normalnim eksploatacijskim uvjetima, tako i u uvjetima graničnih stanja, a s obzirom na višegodišnje iskustvo istraživačkog tima i već postojeću znanstvenu opremu, u prvom redu vršit će se statička i dinamička eksperimentalna ispitivanja različitih konstrukcijskih materijala s naglaskom na određivanje do sada nedostupnih mahančkih značajki specijalnih metalnih materijala (legura), od utvrđivanja statičke i dinamičke čvrstoće u ekstremnim uvjetima, pa do analize i praćenja širenja pukotina kao posljedice cikličkog zamora. U okviru ovoga projekta, eksperimentalno dobiveni podaci doprinjet će formiranju novih i nadopuni postojećih baza materijalnih značajki s ciljem podloge računalnim simulatorima kao osnovnom rezultatu predložena projekta.

which is certainly the most reliable and effective approach, numerical simulations, due to their considerably lower costs, have become a necessity. Since the proper choice of materials is of great significance in the design phase, the experimental determination of material features is extremely important. For certain conventional materials, mechanical parameters are available in the literature, but the emergence of an innovative material requires new experimental testing. This project has been partly conceived with this goal in mind. Experimental research into material properties and their behaviour, particularly under specific conditions, is of the utmost importance in the use of materials under appropriate exploitation conditions.

A large part of the research will be dedicated to the development of new numerical simulators for spatial beam structures and the upgrading of existing ones, with a particular emphasis on thin walled beams made of composite materials, e.g. laminates, functionally graded materials, etc. in extreme conditions, such as elevated and reduced temperatures and humidity. The main aim of the simulations will be to estimate the load carrying capacity of structures, and to predict the occurrence of the limit state in relation to reasons for collapse. To support a complete model of limit load state assessment, both in normal exploitation conditions and in limit load states, and given the many years' experience of the project team and the scientific equipment available, static and dynamic experimental testing of various structural materials will be carried out. This will relate to the determination of previously unavailable mechanical/material parameters, e.g. of certain special metal alloys, such as static and dynamic strength in extreme conditions, and analysis and monitoring of fatigue cracks as a consequence of cyclic fatigue. Through this project, the obtained data, will contribute to the creation of new material databases as well as supplement existing ones. The final goal of the material databases will be to support computer simulators as the basic result of the proposed project.

## NAZIV PROJEKTA | PROJECT TITLE:

**Sustav potpore odlučivanju za zeleniju i sigurniju plovidbu brodova - DESSERT**  
Decision Support System for Green and Safe Ship Routing - DESSERT

### Glavni istraživač

prof. dr. sc., Jasna Prpić – Oršić,  
Tehnički fakultet, Sveučilište u Rijeci

### Principal investigator

Prof. Jasna Prpić - Oršić, D. Sc.,  
Faculty of Engineering, University of Rijeka

### Članovi istraživačkog tima

prof. dr. sc. Odd Magnus Faltinsen,  
Norveško sveučilište znanosti i tehnologije,  
Trondheim, Norveška

prof. dr. sc. Kenji Sasa,  
Kobe University, Zavod za pomorstvo, Kobe,  
Japan

prof. dr. sc. Tomislav Mrakovčić,  
Tehnički fakultet, Sveučilište u Rijeci

prof. dr. sc. Duško Pavletić,  
Tehnički fakultet, Sveučilište u Rijeci

doc. dr. sc. Jonatan Lerga,  
Tehnički fakultet, Sveučilište u Rijeci

doc. Vedran Mrzljak, dr. sc.,  
Tehnički fakultet, Sveučilište u Rijeci

doc. dr. sc. Marko Valčić,  
Tehnički fakultet, Sveučilište u Rijeci

izv. prof. dr. sc., Igor Rudan,  
Pomorski fakultet, Sveučilište u Rijeci

doc. dr. sc., Srđan Žuškin,  
Pomorski fakultet, Sveučilište u Rijeci

dr. sc. Francesco Mauro,  
Sveučilište u Trstu, Trst, Italija

Luca Braidotti,  
Sveučilište u Trstu, Trst, Italija

Natalija Vitali, doktorandica,  
Tehnički fakultet, Sveučilište u Rijeci

asist. Denis Selimović,  
Tehnički fakultet, Sveučilište u Rijeci

asist. Ivan Sulovsky,  
Tehnički fakultet, Sveučilište u Rijeci

### Members of the research team

Prof. Odd Magnus Faltinsen, D. Sc.,  
Norwegian University of Science and  
Technology, Trondheim, Norway

Prof. Kenji Sasa, D. Sc.,  
Kobe University, Department of Maritime  
Sciences, Kobe, Japan

Prof. Tomislav Mrakovčić, D. Sc.,  
Faculty of Engineering, University of Rijeka

Prof. Duško Pavletić, D. Sc.,  
Faculty of Engineering, University of Rijeka

Assist. Prof. Jonatan Lerga, D. Sc.,  
Faculty of Engineering, University of Rijeka

Assist. Prof. Vedran Mrzljak, D. Sc.,  
Faculty of Engineering, University of Rijeka

Assist. Marko Valčić, D. Sc.,  
Faculty of Engineering, University of Rijeka

Assoc. Prof. Igor Rudan, D. Sc.,  
Faculty of Maritime Studies, University of Rijeka

Assist. Prof. Srđan Žuškin, D. Sc.,  
Faculty of Maritime Studies, University of Rijeka

Francesco Mauro, D. Sc.,  
University of Trieste, Trieste, Italy

Luca Braidotti,  
University of Trieste, Trieste, Italy

Natalija Vitali, PhD student,  
Faculty of Engineering, University of Rijeka

Assist. Denis Selimović,  
Faculty of Engineering, University of Rijeka,

Assist. Ivan Sulovsky,  
Faculty of Engineering, University of Rijeka

### Sažetak projekta

Cilj istraživanja u okviru projekta Sustav potpore odlučivanju za zeleniju i sigurniju plovidbu brodova (DESSERT) je razvoj učinkovitog sustava potpore odlučivanju (Decision Support System - DSS) kapetanima broda i zapovjednicima stroja, a koji bi doprinio "zelenijoj" i sigurnijoj plovidbi brodova. Krajnji učinak takvog DSS bilo bi svođenje ljudske pogreške na što manju mjeru odnosno pružanje maksimalno vjerodostojnih podataka i smjernica odgovornim osobama na brodu tijekom plovidbe radi smanjenja onečišćenje okoliša i sigurnosti ljudi i tereta.

### Project summary

The research goal, as part of the framework of the Decision Support System project for green and safe ship navigation – DESSERT, is the development of an effective Decision Support System (DSS) for captains and also machine commanders, which would contribute to the 'greener' and safer navigation of ships. The ultimate effect of such a DSS would be reducing human errors to a minimum, and offering the most credible data and guidance to authorised people on board during navigation in order to reduce environmental pollution and to increase the safety of people and cargo.



Istraživanja vezana uz razvoj DSS-a odvijat će se u dva osnovna smjera: energetska učinkovitija plovidba uz smanjenje emisije stakleničkih plinova i povećanje sigurnosti plovidbe s aspekta izbjegavanja sudara

Cilj je razviti sustav potpore odlučivanju na brodu uzimajući u obzir projektantsku, strojarску i pomorsku ekspertizu radi stvaranja sigurnog i ekološki učinkovitog ili "zelenijeg" broda i plovidbe. Projektni tim sastoji se od znanstvenika koji su stručnjaci u brodogradnji, strojarstvu, pomorskom inženjerstvu i računarstvu i koji omogućuju multidisciplinarno rješavanje ovog problema.

Research related to the development of DSS will take place in two main directions: energy-efficient navigation together with a reduction in greenhouse gas emissions, as well as an increase in navigation safety so as to avoid collisions.

The objective is to develop a decision support system on board that takes into account design, mechanical and maritime expertise in order to create safe and environmentally friendly or 'greener' ships and navigation. The project team consists of scientists and experts in naval architecture, mechanical engineering, marine engineering and computer engineering, which allows a multi-disciplinary approach to problem-solving.

#### NAZIV PROJEKTA | PROJECT TITLE:

##### Strojno učenje za prijenos znanja u medicinskoj radiologiji - RadiologyNET

Machine Learning for Knowledge Transfer in Medical Radiology - RadiologyNET

#### Glavni istraživač

izv. prof. dr. sc. Ivan Štajduhar,  
Tehnički fakultet, Sveučilište u Rijeci

#### Principal investigator

Assoc. Prof. Ivan Štajduhar, D. Sc.,  
Faculty of Engineering, University of Rijeka

#### Članovi istraživačkog tima

prof. dr. sc. Damir Miletić, dr. med.,  
Klinički bolnički centar Rijeka,  
Sveučilište u Rijeci

doc. dr. sc. Matija Milanić,  
Fakultet za matematiku i fiziku, Sveučilište u  
Ljubljani, Slovenija

doc. dr. sc. Goran Glavaš,  
Fakultet za poslovnu informatiku i matematiku,  
Sveučilište u Mannheimu, Njemačka

dr. sc. Sebastian Tschauner, dr. med.,  
Medicinsko sveučilište u Grazu, Austrija

Mihaela Mamula Saračević, dr. med.,  
Klinički bolnički centar Rijeka,  
Sveučilište u Rijeci

asist. Franko Hrzić,  
Tehnički fakultet, Sveučilište u Rijeci

#### Members of the research team

Prof. Damir Miletić, M.D., D. Sc.,  
Clinical Hospital Center of Rijeka,  
University of Rijeka

Assist. Prof. Matija Milanić, D. Sc.,  
Faculty of Mathematics and Physics, University  
of Ljubljana, Slovenia

Assist. Prof. Goran Glavaš, D. Sc.,  
School of Business Informatics and  
Mathematics, University of Mannheim, Germany

Sebastian Tschauner, M.D., D. Sc.,  
Medical University of Graz, Austria

Mihaela Mamula Saračević, M.D.,  
Clinical Hospital Center of Rijeka,  
University of Rijeka

Assist. Franko Hrzić,  
Faculty of Engineering, University of Rijeka

#### Sažetak projekta

Medicinska radiologija često se koristi u kliničkoj analizi za postavljanje medicinske dijagnoze na neinvazivan način. Razmatranjem morfoloških karakteristika promatranog područja, kliničari mogu odrediti prisutnost ozljede ili bolesti bez potrebe za provedbom invazivnog zahvata. Svrha računalno potpomognute dijagnostike (CAD) je pružiti pomoć liječnicima u interpretaciji zabilježenih podataka. U posljednje vrijeme primjena tehnika strojnog učenja počela uzimati maha u ovom području, povećavajući točnost ručno stvorenim modelima ili ih čak u potpunosti

#### Project summary

Medical radiology is often used in clinical analysis to establish a medical diagnosis in a non-invasive manner. By considering the morphological properties of the observed area, clinicians can determine the presence of an injury or disease without the need for invasive surgery. The purpose of computer-aided diagnosis (CAD) is to help physicians interpret the recorded data. Recently, the use of machine learning techniques has begun to grow rapidly in this area, increasing the accuracy of manually-crafted models, or even entirely replacing them.

zamjenjujući. Recentan očigledan porast primjene tih tehnika u analizi medicinskih slika omogućen je zbog šire dostupnosti podataka, povećane procesne moći računala i znatnijeg napretka ostvarenog korištenjem postupaka dubokog učenja u primjenama računalnog vida. Ovaj je razvoj pak stvorio potencijal za uvođenje značajnih promjena u biologiji i medicini, u laboratorijskoj i u kliničkoj. Jedna od bitnih prednosti tehnika strojnog učenja u medicini, u odnosu na tehnike filtriranja, leži u njihovoj sposobnosti otkrivanja novih postupaka dijagnosticiranja bolesti, dotad nezamislivih. Dodatno, zbog kompleksnosti modeliranja stanja usko vezanog uz karakteristike pacijenta, tehnike strojnog učenja proširile su se kao bitan čimbenik u implementaciji personalizirane medicine u klinici. Predloženo istraživanje unaprijedit će postojeće znanje vezano uz modeliranje u analizi medicinskih slika uvođenjem zajedničke platforme za učenje prijenosom znanja za izgradnju preciznijih prediktivnih modela namijenjenih automatizaciji postupaka otkrivanja bolesti i ozljeda u medicinskim CAD sustavima, što će u konačnici rezultirati poboljšanjem zdravstvene skrbi.

A recent apparent increase in the use of these techniques in medical image analysis has been facilitated due to the wider availability of data, increased computer processing power, and more significant progress achieved through the use of deep-learning techniques in machine vision applications. This development, in turn, has created the potential for introducing significant changes to biology and medicine, both in the laboratory and in the clinic. One of the essential advantages of machine-learning techniques in medicine, in comparison to filtering techniques, is the ability to unearth new, previously inconceivable, procedures for diagnosing diseases. Additionally, due to the complexity of modelling specific conditions closely related to a patient's characteristics, machine-learning techniques are increasingly becoming an essential factor in the implementation of personalised medicine in clinics. The proposed research will advance existing knowledge concerning modelling for medical image analysis by introducing a common transfer-learning platform for building more accurate predictive models intended to automate disease and injury detection procedures in medical CAD systems, ultimately resulting in improved healthcare.

#### NAZIV PROJEKTA | PROJECT TITLE:

##### Povećanje energetske učinkovitosti izmjenjivača topline - HEXENER

Enhancement of the Heat Exchanger Energy Efficiency - HEXENER

#### Glavni istraživač

prof. dr. sc. Anica Trp,  
Tehnički fakultet, Sveučilište u Rijeci

#### Principal investigator

Prof. Anica Trp, D. Sc.,  
Faculty of Engineering, University of Rijeka

#### Članovi istraživačkog tima

prof. dr. sc. Kristian Lenić,  
Tehnički fakultet, Sveučilište u Rijeci

prof. dr. sc. Branimir Pavković,  
Tehnički fakultet, Sveučilište u Rijeci

izv. prof. dr. sc. Igor Wolf,  
Tehnički fakultet, Sveučilište u Rijeci

doc. dr. sc. Paolo Blečić,  
Tehnički fakultet, Sveučilište u Rijeci

doc. dr. sc. Igor Bonefačić,  
Tehnički fakultet, Sveučilište u Rijeci

doc. dr. sc. Vladimir Glažar,  
Tehnički fakultet, Sveučilište u Rijeci

doc. dr. sc. Boris Delač,  
Tehnički fakultet, Sveučilište u Rijeci

asist. Josip Batista,  
Tehnički fakultet, Sveučilište u Rijeci

asist. Mateo Kirinčić,  
Tehnički fakultet, Sveučilište u Rijeci

#### Members of the research team

Prof. Kristian Lenić, D. Sc.,  
Faculty of Engineering, University of Rijeka

Prof. Branimir Pavković, D. Sc.,  
Faculty of Engineering, University of Rijeka

Assoc. Prof. Igor Wolf, D. Sc.,  
Faculty of Engineering, University of Rijeka

Assist. Prof. Paolo Blečić, D. Sc.,  
Faculty of Engineering, University of Rijeka

Assist. Prof. Igor Bonefačić, D. Sc.,  
Faculty of Engineering, University of Rijeka

Assist. Prof. Vladimir Glažar, D. Sc.,  
Faculty of Engineering, University of Rijeka

Assist. Prof. Boris Delač, D. Sc.,  
Faculty of Engineering, University of Rijeka

Assist. Josip Batista,  
Faculty of Engineering, University of Rijeka

Assist. Mateo Kirinčić,  
Faculty of Engineering, University of Rijeka



asist. Fran Torbarina,  
Tehnički fakultet, Sveučilište u Rijeci

Assist. Fran Torbarina,  
Faculty of Engineering, University of Rijeka

### Sažetak projekta

Predmet istraživanja projekta je povećanje energetske učinkovitosti izmjenjivača topline. Istraživanja će biti usmjerena na analizu izmjene topline i povećanja energetske učinkovitosti raznih tipova lamelnih izmjenjivača topline kao i latentnog spremnika topline kojega možemo smatrati posebnim tipom izmjenjivača. Znanstvenoistraživački ciljevi obuhvaćaju: numeričko i eksperimentalno istraživanje utjecaja geometrijskih karakteristika izmjenjivača topline na fizikalni proces izmjene topline i učinkovitost, numeričko i eksperimentalno istraživanje utjecaja pogonskih uvjeta izmjenjivača topline na fizikalni proces izmjene topline i učinkovitost, numeričko i eksperimentalno istraživanje utjecaja pogonskih uvjeta, geometrije i karakteristika akumulatora topline na izmjenu topline i učinkovitost latentnih spremnika topline te istraživanje pohrane energije u sustavu obnovljivih izvora energije s latentnim spremnikom. Očekivani znanstveni doprinos istraživanja je proširenje postojećih znanstvenih spoznaja vezanih za povećanje energetske učinkovitosti lamelnih izmjenjivača topline, latentnog spremnika topline kao komponente sustava i cijelog sustava obnovljivih izvora energije s latentnim spremnikom.

### Project summary

The research topic of the project is the enhancement of heat exchanger energy efficiency. Investigations will focus on the analysis of heat transfer and the enhancement of energy efficiency of various fin and tube heat exchangers, as well as of latent heat storage units, which are a special type of heat exchanger. Scientific research objectives include: numerical and experimental investigation of the influence of heat exchanger geometry characteristics on the physical process of heat transfer and efficiency, a numerical and experimental investigation of the influence of heat exchanger operating conditions on the physical process of heat transfer and efficiency, a numerical and experimental investigation of the influence of latent heat storage operating conditions, geometry and phase change material characteristics on heat transfer and efficiency, as well as an analysis of energy storage in a renewable energy system with a latent heat storage unit. The expected scientific contribution of the research is an increase in existing scientific knowledge related to the energy efficiency of fin and tube heat exchangers, latent heat storage as a system component and the overall system of renewable energy sources with latent heat storage.

## 2.7.2 EU PROJEKTI EU PROJECTS

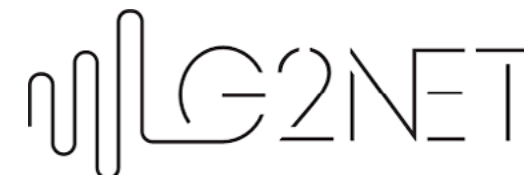

### NAZIV PROJEKTA | PROJECT TITLE:

#### Mreža za gravitacijske valove, geofiziku i strojno učenje – Cost akcija CA17137

A network for Gravitational Waves, Geophysics and Machine Learning – Cost Action CA17137

#### Voditeljica projekta

dr. sc. Elena Cuoco,  
European Gravitational Observatory, Pisa, Italija

#### Project chair

Elena Cuoco, D. Sc.,  
European Gravitational Observatory, Pisa, Italy

#### Lokalni koordinatori

doc. dr. sc. Jonatan Lerga,  
Sveučilište u Rijeci, Tehnički fakultet  
izv. prof. dr. sc. Ivan Štajduhar,  
Sveučilište u Rijeci, Tehnički fakultet

#### Local coordinators

Assist. Prof. Jonatan Lerga, D. Sc.,  
University of Rijeka, Faculty of Engineering  
Assoc. Prof. Ivan Štajduhar, D. Sc.,  
University of Rijeka, Faculty of Engineering

#### U partnerstvu s institucijama iz zemalja

Belgija, Bosna i Hercegovina, Cipar, Danska, Finska, Francuska, Njemačka, Grčka, Mađarska, Irska, Izrael, Italija, Malta, Moldavija, Crna Gora, Nizozemska, Sjeverna Makedonija, Poljska, Portugal, Rumunjska, Srbija, Slovačka, Španjolska, Švedska, Turska, Ujedinjeno Kraljevstvo, Sjedinjene Američke Države, Australija

#### In partnership with:

Belgium, Bosnia and Herzegovina, Cyprus, Denmark, Finland, France, Germany, Greece, Hungary, Ireland, Israel, Italy, Malta, Moldova, Montenegro, the Netherlands, North Macedonia, Poland, Portugal, Romania, Serbia, Slovakia, Spain, Sweden, Turkey, the United Kingdom, the United States, Australia

#### Sažetak projekta

Značajno otkriće gravitacijskih valova 14. rujna 2015. g. bilo je omogućeno sinergijom tehnika koje se oslanjaju na stručnost u fizici, matematici, informacijskim znanostima i računarstvu. Trenutno postoji veliki interes za strojno učenje, duboko učenje, probleme klasifikacije, dubinsku analizu i vizualizaciju podataka i, općenito, za razvoj novih tehnika i algoritama za učinkovito rukovanje složenim i voluminoznim skupovima podataka poznatih pod nazivom „Big Data“ u raznovrsnim disciplinama, od društvenih do prirodnih znanosti. Brzi porast računalne snage kojom raspolažemo i razvoj inovativnih tehnika za brzu analizu podataka bit će od ključnog značaja za novo uzbudljivo područje astronomije gravitacijskih valova, za specifične teme poput sustava upravljanja i povratne sprege za sljedeću generaciju detektora, uklanjanja šuma i alata za analizu podataka. Otkriće signala gravitacijskih valova iz sudarajućih binarnih crnih rupa i izgledno postojanje novoopazivne

#### Project summary

The breakthrough discovery of gravitational waves on 14 September 2015 was made possible through the synergy of techniques drawing from expertise in physics, mathematics, information science and computing. At present, there is a rapidly growing interest in machine learning, deep learning, classification problems, data mining and visualisation and, in general, in the development of new techniques and algorithms for efficiently handling the complex and massive data sets found in what has been coined "Big Data", across a broad range of disciplines, ranging from Social Sciences to Natural Sciences. The rapid increase in computing power at our disposal and the development of innovative techniques for the rapid analysis of data will be vital in the exciting new field of gravitational wave astronomy, in specific topics such as control and feedback systems for next-generation detectors, noise removal and data analysis tools. The discovery



populacije masivnih crnih rupa zvjezdanog podrijetla, učinilo je analizu niskofrekventnih podataka o gravitacijskim valovima presudnom u znanosti o gravitacijskim valovima. Na performanse niskofrekventnih zemaljskih detektora gravitacijskih valova uvelike utječe sposobnost rukovanja potiskivanjem ambijentalnog šuma. Cilj ove akcije je stvaranje široke mreže znanstvenika iz četiri različita područja stručnosti, a to su fizika gravitacijskih valova, geofizika, računarstvo i robotika, sa zajedničkim ciljem rješavanja izazova u analizi podataka i karakterizaciji šuma za detektore gravitacijskih valova.

of gravitational wave signals from colliding binary black holes and the likely existence of a newly observable population of massive, stellar-origin black holes, has made the analysis of low-frequency gravitational wave data a crucial mission of gravitational wave science. The low-frequency performance of Earth-based GW detectors is largely influenced by the capability of handling ambient seismic noise suppression. This Cost Action aims at creating a broad network of scientists from four different areas of expertise, namely gravitational wave physics, Geophysics, Computing Science and Robotics, with a common goal of tackling challenges in data analysis and noise characterisation for gravitational wave detectors.



#### NAZIV PROJEKTA | PROJECT TITLE:

#### Povezivanje obrazovne i istraživačke zajednice za inovativno društvo osvještano ograničenja resursa – Cost akcija CA19135

Connecting Education and Research Communities for an Innovative Resource Aware Society – Cost Action CA19135

#### Predlagatelj projekta

dr. sc. Gordana Rakić,  
Sveučilište Novi Sad, Prirodno-matematički  
fakultet, Srbija

#### Project proposer

Gordana Rakić, D. Sc.,  
University of Novi Sad, Faculty of Science,  
Serbia

#### Lokalni koordinator

doc. dr. sc. Goran Mauša,  
Tehnički fakultet, Sveučilište u Rijeci

#### Local coordinator

Assist. Prof. Goran Mauša, D. Sc.,  
Faculty of Engineering, University of Rijeka

#### U partnerstvu s institucijama iz zemalja:

Belgija, Bosna i Hercegovina, Bugarska,  
Cipar, Češka, Danska, Estonija, Finska,  
Francuska, Njemačka, Grčka, Mađarska, Irska,  
Izrael, Italija, Latvija, Luksemburg, Moldavija,  
Nizozemska, Norveška, Poljska, Portugal,  
Rumunjska, Srbija, Slovačka, Slovenija,  
Španjolska, Švicarska, Ujedinjeno Kraljevstvo

#### In partnership with:

Belgium, Bosnia and Herzegovina, Bulgaria,  
Cyprus, Czech Republic, Denmark, Estonia,  
Finland, France, Germany, Greece, Hungary,  
Ireland, Israel, Italy, Latvia, Luxembourg,  
Moldova, Netherlands, Norway, Poland,  
Portugal, Romania, Serbia, Slovakia, Slovenia,  
Spain, Switzerland, United Kingdom

#### Sažetak projekta

Paralelne računalne platforme revolucionarno su izmijenile hardversku infrastrukturu pružajući obradu podataka visokih performansi, niske potrošnje energije i specijalizirane

#### Project summary

Parallel computing platforms have revolutionised the hardware landscape by providing high-performance, low-energy, and specialised (viz. heterogeneous) processing capabilities to a

(naime, heterogene) mogućnosti u različitim domenama primjene, uključujući mobilno i ugrađeno računarstvo, podatkovna središta i računarstvo visokih performansi. Međutim, kako bi iskoristili svoj potencijal, dizajneri sustava moraju uspostaviti teško ostvarivu ravnotežu u raspodjeli resursa komponentama aplikacije, nastojeći izbjeći nedovoljne ili pretjerane odredbe radi najgorih slučajeva profila upotrebe. Problematično povezivanje hardverskih komponenta u nove platforme i složeno ponašanje paralelnih aplikacija podižu oprečne zahtjeve za resursima, više u pametnim, (samo) prilagodljivim i autonomnim sustavima. Ovaj scenarij predstavlja težak izazov razumijevanja i kontroliranja, statički i dinamički, kompromisa u korištenju resursa sustava (vremena, prostora, energije i podataka) iz perspektive napora razvoja i održavanja.

Davanje kompromisa u korištenju resursa pri specifikaciji, tehničkom oblikovanju, implementaciji i za vrijeme izvođenja zahtijeva duboku svijest o lokalnom i globalnom utjecaju uzrokovanom paralelnim dretvama kod aplikacija za pojedinačne resurse. Takva je svijest presudna za akademske istraživače i industrijske djelatnike u svim europskim zemljama i zemljama članicama COST-a i, prema tome, strateški prioritet. Postizanje ovog cilja zahtijeva djelovanje na dvije razine: (1) umrežavanje inače fragmentiranih istraživačkih napora ka cjelovitijim pogledima na problem i rješenja; (2) iskorištavanje odgovarajućih obrazovnih i tehnoloških sredstava za poboljšanje razumijevanja i upravljanja resursima akademske zajednice i industrije ekonomija s lošim učinkom, kako bi se promovirala suradnja unutar Europe i postigle ekonomske i društvene koristi.

variety of application domains, including mobile, embedded, data-centre and high-performance computing. However, to leverage their potential, system designers must strike a difficult balance in the apportionment of resources to the application components, striving to avoid under- or over-provisions against worst-case utilisation profiles. The entanglement of hardware components in the emerging platforms and the complex behaviour of parallel applications raise conflicting resource requirements, more so in smart, (self-)adaptive and autonomous systems. This scenario presents the hard challenge of understanding and controlling, statically and dynamically, the trade-offs in the usage of system resources (time, space, energy, and data) from the perspective of development and maintenance efforts.

Making resource-usage trade-offs at specification, design, implementation, and run time requires profound awareness of the local and global impact caused by parallel threads of applications on individual resources. Such awareness is crucial for academic researchers and industrial practitioners across all European and COST member countries, and, therefore, a strategic priority. Reaching this goal requires acting at two levels: (1) networking otherwise fragmented research efforts towards more holistic views of the problem and the solution; (2) leveraging appropriate educational and technology assets to improve the understanding and management of resources by the academia and industry of underperforming economies, in order to promote cooperation inside Europe and achieve economic and societal benefits.



#### NAZIV PROJEKTA | PROJECT TITLE:

#### Europska mreža za osiguravanje integriteta hrane korištenjem nerazornih spektralnih senzora – Cost akcija CA19145

European network for assuring food integrity using non-destructive spectral sensors – Cost Action CA19145

#### Voditeljica projekta

prof. dr. sc. Dolores Perez-Marin,  
University of Cordoba, Španjolska

#### Project chair

Prof. Dolores Perez-Marin, D. Sc.,  
University of Cordoba, Spain

**Lokalni koordinator**

izv. prof. dr. sc. Ivan Štajduhar,  
Sveučilište u Rijeci, Tehnički fakultet

**Local coordinator**

Assoc. Prof. Ivan Štajduhar, D. Sc.,  
University of Rijeka, Faculty of Engineering

**U partnerstvu s institucijama iz zemalja**

Belgija, Bosna i Hercegovina, Cipar, Danska, Finska, Francuska, Njemačka, Grčka, Mađarska, Irska, Izrael, Italija, Malta, Moldavija, Crna Gora, Nizozemska, Sjeverna Makedonija, Poljska, Portugal, Rumunjska, Srbija, Slovačka, Španjolska, Švedska, Turska, Ujedinjeno Kraljevstvo, Sjedinjene Američke Države, Australija

**In partnership with:**

Austria, Belgium, Bulgaria, Cyprus, Denmark, Estonia, France, Germany, Greece, Hungary, Ireland, Israel, Italy, Malta, Moldova, the Netherlands, North Macedonia, Norway, Poland, Portugal, Romania, Serbia, Slovenia, Spain, Sweden, Switzerland, Turkey, the United Kingdom, Russian Federation, the United States, Australia, South Korea, South Africa

**Sažetak projekta**

Unutar prehrambene industrije sve je veća potreba za pružanjem informacija o proizvodima radi zadovoljenja standarda kvalitete i zaštite proizvoda od prijevara s hranom. Najnoviji tehnološki razvoj i napredak u analizi velikih podataka pružaju priliku za inkrementalne promjene koje mogu transformirati ulogu osiguranja integriteta hrane iz samo stroge usklađenosti u onu koja rješava širok raspon poslovno kritičnih pitanja, uključujući kvalitetu, sigurnost i rješenja autentičnosti. Nerazorni spektroskopski senzori (NDSS), poput NIR spektroskopije, fluorescencije, Ramanove spektroskopije ili hiperspektalnog snimanja, omogućuju brzu, nedestruktivnu i ekološki sigurnu procjenu više parametara u raznovrsnim prehrambenim proizvodima. Ove se tehnologije u prehrambenoj industriji primjenjuju pretežno na proizvodnoj liniji. Industrija zahtijeva njihovo postavljanje in situ i po mogućnosti online za potpunu kontrolu procesa u cjelovitom lancu hrane. Ovi zahtjevi uvode ograničenja u dizajn senzora i razvoj kalibracije koji se obično ne primjenjuju na laboratorijske instrumente. Dugoročna stabilnost instrumenata, robusnost kalibracija, integracija senzora u proizvodnim okruženjima, prenosivost podataka i izgradnja sustava za stvarnovremensko donošenje odluka kritična su pitanja koja treba razmotriti. SensorFINT će stvoriti živahnu mrežu, kombinirajući iskustvo u istraživanju, proizvodnji, obuci i prijenosu tehnologije u vezi s NDSS-om. Akcija će djelovati razvijanjem generičkih rješenja za postojeće i nastajuće probleme u neinvazivnoj kontroli procesa hrane izgradnjom „pametnog sustava kontrole hrane“, kao i razvojem kadra dobro obučanih mladih istraživača koji će znanstvene rezultate pretvoriti u stvarnost koja odgovara potrebama privrede.

**Project summary**

There is an increasing need for the food industry to provide information on its products in order to satisfy quality standards and to protect products from food fraud. Recent developments in technology and advances in big data analytics provide the opportunity for step-changes that can transform the role of food integrity assurance from one of just strict conformance to one that addresses a wide range of business critical concerns, including quality, safety and authenticity solutions. Non-destructive Spectroscopic Sensors (NDSS), such as NIR Spectroscopy, Fluorescence, Raman or Hyperspectral imaging, enable rapid, non-destructive and environmentally-safe assessment of multiple parameters in a variety of food products. Most applications of these technologies in the food industry are made at-line. Industry requires them to be deployed in situ and preferably online for full process control over the entire food chain. These requirements introduce constraints on sensor design and calibration development which do not normally apply to laboratory-based instruments. The long-term stability of instruments, robustness of calibrations, sensor integration in production environments, transferability of data and the building of real-time decision-making systems are critical issues to be considered. SensorFINT will create a vibrant network, combining experience in research, manufacturing, training and technology transfer in relation to NDSS. The Action will operate by developing generic solutions to existing and emerging problems in non-invasive food process control, building a “smart food control system”, as well as developing a cadre of well-trained young researchers who will convert scientific results into a reality that matches industrial needs.

**NAZIV PROJEKTA | PROJECT TITLE:****Optimizacija ispitnih konstrukcija (ODIN) – Cost akcija CA18203**

Optimising Design for Inspection (ODIN) – Cost Action CA18203

**Voditelj projekta**

prof. dr. sc. Rhys Pullin,  
Cardiff University, School of Engineering,  
Cardiff, Ujedinjeno Kraljevstvo

**Project chair**

Prof. Rhys Pullin, D. Sc.,  
Cardiff University, School of Engineering,  
Cardiff, United Kingdom

**Lokalni koordinator**

prof. dr. sc. Saša Zelenika,  
Sveučilište u Rijeci, Tehnički fakultet

**Local coordinator**

Prof. Saša Zelenika, D. Sc.,  
University of Rijeka, Faculty of Engineering

**U partnerstvu s institucijama iz zemalja**

Belgija, Bosna i Hercegovina, Bugarska, Cipar, Češka, Danska, Estonija, Francuska, Grčka, Hrvatska, Irska, Island, Italija, Izrael, Latvija, Litva, Nizozemska, Njemačka, Poljska, Portugal, Rumunjska, Sjeverna Makedonija, Slovenija, Srbija, Španjolska, Švedska, Turska, Ujedinjeno Kraljevstvo, Kanada, Kina, SAD

**In partnership with:**

Belgium, Bosnia and Herzegovina, Bulgaria, Croatia, Cyprus, the Czech Republic, Denmark, Estonia, France, Germany, Greece, Iceland, Ireland, Israel, Italy, Latvia, Lithuania, the Netherlands, North Macedonia, Poland, Portugal, Romania, Serbia, Slovenia, Spain, Sweden, Turkey, the United Kingdom, Canada, China and the USA

**Sažetak projekta**

U laboratorijskim se uvjetima tehnike nerazornog ispitivanja temeljene na ultrazvuku, prikupljanju i pretvorbi niskorazinske energije iz okoliša i bežičnim osjetnicima sve češće pokazuju vrlo učinkovitima pri određivanju oštećenja zrakoplovnih komponenti. Te komponente obuhvaćaju i kritične elemente poput vanjske oplata, motora, opreme za slijetanje i kontrolnih površina zrakoplova. Jasna je, stoga, potreba da se navedeni pristup ispitivanju oštećenja uzme u obzir i integrira već u fazi konstrukcije zrakoplova. Da bi se potaknuo integrativni okvir razvoja optimiziranih autonomnih osjetilnih konstrukcija za dijagnozu i predviđanje oštećenja, ova će COST akcija okupiti vrhunske europske stručnjake koji se bave predmetnim područjima te tako omogućiti razvoj prototipova, ali i edukacijskih aktivnosti (uključujući programe obuke), što će u konačnici rezultirati čistim i sigurnijim letovima. Integracijom nerazornih sustava ispitivanja temeljenih na ultrazvučnim valovima sa sustavima prikupljanja i pretvorbe niskorazinske energije iz okoliša i sustavima bežičnih osjetnika već u fazi koncipiranja konstrukcije, ova će COST akcija maksimizirati korist stalnog

**Project summary**

Ultrasound-based NDE techniques, energy harvesting and wireless sensor networks have increasingly been demonstrated to be effective in monitoring damage to aerospace components in a laboratory setting. These components include critical elements such as airframe, engines, landing gears and control surfaces. However, there is an urgent need to integrate these approaches and techniques at the inception of an aircraft. This COST Action will bring together top European experts across these areas to support the development of an integrated framework for optimised self-sensing structures capable of diagnosis and prognosis, together with demonstrators and educational activities, including training programmes, which will ultimately lead to cleaner and safer skies. This Action will maximise the full benefit of in-service, continuous monitoring of critical aerospace structures by integrating ultrasonic wave-based non-destructive evaluation (NDE), energy harvesting and wireless sensor technologies at the design conception phase. Optimisation (sensor/structure), computational modelling, advanced signal processing and



praćenja oštećenja kritičnih komponenti za vrijeme rada zrakoplova. Akcija će, tako, integrirati optimizaciju osjetnika i strukture, numeričko modeliranje, naprednu obradu signala te moderne konstrukcijske pristupe, sve s ciljem razvijanja inovativnih tehnoloških postupaka, konstrukcijskih alata i smjernica za dobivanje prvih inačica autonomnih zrakoplovnih konstrukcija koje će omogućiti točno predviđanje strukturnog ponašanja kritičnih komponenti. To će unaprijediti načine održavanja, povećati dostupnost resursa, smanjiti jaz između znanstvenog i industrijskog sektora, omogućiti širu primjenu naprednih materijala, smanjiti radne troškove te, naposljetku, omogućiti sigurnija i ekološki naprednija zrakoplovna prijevozna sredstva.

advanced design approaches will be integrated to produce a novel framework, design tools and guidelines for the delivery of the first generation of a self-sensing aircraft capable of delivering accurate structural prognosis. This will improve maintenance strategies, increase asset availability, bridge the gap between research and industry, enable an increased use of advanced materials, reduce operating costs and ultimately deliver safer and greener air transport solutions.



#### NAZIV PROJEKTA | PROJECT TITLE:

##### Digital Empowering Trough HPC Education – HiPowerEd

Digital Empowering Trough HPC Education – HiPowerEd

#### Voditelj projekta

prof. dr. sc. Lado Kranjčević,  
Tehnički fakultet, Sveučilište u Rijeci

#### Project chair

Prof. Lado Kranjčević, D. Sc.,  
Faculty of Engineering, University of Rijeka

#### Projektne konzorcije

Tehnički fakultet Sveučilišta u Rijeci – prijavitelj,  
Technische universitaet Muenchen – partner,  
Danmarks tekniske universitet Copenhagen – partner,  
Universita degli studi di Trieste – partner,  
Visoko učiliste Algebra Zagreb – partner.

#### Project consortium

Faculty of Engineering University of Rijeka – lead partner,  
Technische universitaet Muenchen – partner,  
Danmarks tekniske universitet Copenhagen – partner,  
Universita degli studi di Trieste – partner,  
Visoko učiliste Algebra Zagreb – partner.

#### Članovi istraživačkog tima s Tehničkog fakulteta Sveučilišta u Rijeci

prof. dr. sc. Siniša Družeta  
asist. dr. sc. Luka Grbčić

#### Members of the research team from the Faculty of Engineering University of Rijeka

Prof. Siniša Družeta, D. Sc.  
Assist. Luka Grbčić, D. Sc.

#### Sažetak projekta

Cilj projekta je upoznati mlade istraživače-asistente, doktorande, studente diplomskog i preddiplomskog studija s primijenjenim računarstvom, s naglaskom na superračunanje sa svim aspektima vezanim uz niz znanstvenih disciplina, katalizirati formiranje mreža, pružati mentorstvo preko članova fakulteta i stručnjaka za superračunanje iz poznatih centara, olakšati

#### Project summary

The objective of the project is to familiarise young people (young researchers - assistants and doctoral students, graduate and undergraduate students) with applied computer science, focusing on supercomputing and all major state-of-the-art aspects related to HPC for a broad range of scientific disciplines, to catalyse the formation of networks, provide mentoring

međunarodnu razmjenu i otvoriti daljnje mogućnosti prijenosa znanja. Napredni projektni programi prilagođeni su mladim znanstvenicima i stručnjacima kojima je potrebna potpuna visokotehnološka superračunalna struktura kako bi svoje aktivnosti podigli na višu tehnološku razinu. Projekt proizvodi potpun potporni okvir za superračunanje s određenim rješenjima u različitim znanstvenim područjima za učinkovito uvođenje budućih znanstvenika i stručnjaka u superračunanje. Partneri na projektu su Tehničko Sveučilište München, Tehničko sveučilište u Danskoj, Sveučilište u Trstu i Sveučilište Algebra.

through faculty members and supercomputing experts from renowned HPC centres, and to facilitate international exchange and open further career options. The advanced project programmes are tailored to young scientists and professionals who need a complete high-tech HPC structure to raise their activities to a higher technological level. The project produces a complete supportive HPC framework with designated solutions in various scientific fields to efficiently introduce future scientists and professionals to HPC. Project partners include TU Munich, TU Denmark, University of Trieste and Algebra University College.



#### NAZIV PROJEKTA | PROJECT TITLE:

##### ICCT – interaktivni tečaj za automatsko upravljanje

ICCT – Interactive Course for Control Theory

#### Lokalni koordinator

doc. dr. sc. Sandi Ljubić,  
Tehnički fakultet, Sveučilište u Rijeci

#### Local coordinator

Assist. Prof. Sandi Ljubić, D. Sc.,  
Faculty of Engineering, University of Rijeka

#### Članovi tima

Tehnički fakultet, Sveučilište u Rijeci  
doc. dr. sc. Sandi Ljubić  
asist. Alen Salkanović  
asist. Ana Vranković  
asist. Franko Hrzić

#### Members of the team

Faculty of Engineering, University of Rijeka  
Assist. Prof. Sandi Ljubić, D. Sc.,  
Assist. Alen Salkanović  
Assist. Ana Vranković  
Assist. Franko Hrzić

Fakulteta za strojništvo, Univerza v Ljubljani,  
Slovenija (prijavitelj Projekta)

izv. prof. dr. sc. Primož Podržaj

Miha Finžgar, doktorand

Žan Pirnar, doktorand

Faculty of Mechanical Engineering, University of Ljubljana, Slovenia (Project applicant)

Assoc. Prof. Primož Podržaj, D. Sc.

Miha Finžgar, PhD student

Žan Pirnar, PhD student

Dipartimento di Ingegneria Civile e Industriale,  
Universita di Pisa, Italija

izv. prof. dr. sc. Michele Lanzetta

izv. prof. dr. sc. Lorenzo Pollini

Department of Civil and Industrial Engineering,  
University of Pisa, Italy

Assoc. Prof. Michele Lanzetta, D. Sc.

Assoc. Prof. Lorenzo Pollini, D. Sc.

Gépezsmérnöki Kar, Budapesti Műszaki és  
Gazdaságtudományi Egyetem, Mađarska

prof. dr. sc. Péter Korondi

doc. dr. sc. Budai Csaba

Pizág Bertalan, doktorand

Agnes Urbin, doktorandica

Faculty of Mechanical Engineering, Budapest  
University of Technology and Economics, Hungary

Prof. Péter Korondi, D. Sc.

Assist. Prof. Budai Csaba, D. Sc.

Pizág Bertalan, PhD student

Agnes Urbin, PhD student





**Sažetak projekta**

Teorija automatskog upravljanja tema je koja pronalazi široku primjenu u inženjerstvu i prirodnim znanostima. Vrlo je čest pojam u elektrotehnici, strojarstvu i procesnom inženjerstvu. Posebno s aspekta Industrije 4.0, jasna je potreba temeljitog razumijevanja koncepata koji se poučavaju unutar kolegija povezanih s automatskim upravljanjem. Rezultati nedavnih istraživanja ukazuju kako je teorija automatskog upravljanja studentima, u usporedbi s drugim sadržajima, teška. Odnosni rezultati također otkrivaju da je interaktivni tečaj sa značajkama virtualnog laboratorija preferirani način za učenje relevantne materije. Budući da takvi resursi za učenje nisu dostupni, glavni cilj ovog ERASMUS+ projekta jest razviti internetski interaktivni tečaj i potpunu web orijentiranu platformu sa svrhom pružanja jednostavne integracije sadržaja koji se odnosi na automatsko upravljanje. Kako bi se adresirali različiti aspekti u provedbi projekta, uspostavljeno je strateško partnerstvo između četiri sveučilišta (Sveučilište u Ljubljani, Slovenija – strojarstvo, Sveučilište u Pisi, Italija – proizvodno inženjerstvo, Sveučilište u Budimpešti, Mađarska – elektrotehnika i robotika i Sveučilište u Rijeci, Hrvatska – računarstvo). Tijekom razvoja interaktivnog tečaja uspješno se ostvaruje razmjena ideja i dobrih praksi s obzirom na sve dionike (učenike i nastavnike) iz različitih zemalja i s različitim razinom domenskog znanja.

Projekt se, dakle, bavi izazovima povezanim s učenjem i poučavanjem tema iz teorije automatskog upravljanja te motivacijom studenata za stjecanje znanja putem odgovarajućeg interaktivnog tečaja. Projekt također adresira novonastale potrebe za učenjem na daljinu i stvaranjem edukativnih digitalnih sadržaja zbog aktualne pandemije COVID-19. Glavni rezultat projekta je na webu zasnovan interaktivni tečaj za učenje teorije automatskog upravljanja koji studentima omogućava aktivnu interakciju sa danim sustavima i praćenje njihovih odziva u stvarnom vremenu. Studenti također mogu provjeriti svoje znanje rješavanjem ispitnih zadataka. Interaktivni tečaj dodatno je obogaćen popratnim udžbenikom koji uključuje četiri glavne teme: matematičko uporište, vremensku domenu, frekvencijsku domenu i prostor stanja. Sadržaj interaktivnog tečaja (implementirani interaktivni primjeri) i udžbenik objavljeni su pod licencom otvorenog koda. Rezultati projekta diseminirani su putem različitih digitalnih platformi, uključujući LinkedIn, Github, Twitter, Reddit i ResearchGate.

**Project summary**

Control Theory is a topic that has a widespread application throughout engineering and natural sciences. It is very common in electrical, mechanical and process engineering. Especially from the Industry 4.0 point of view, it is clear that a thorough understanding of the concepts taught in Control Theory related subjects is needed. The results of recent surveys clearly show that students find Control Theory difficult in comparison with other courses. They also show that an interactive course, with virtual laboratory features, would be a preferred way of studying the relevant material. As no such learning resource is available, the main goal of this ERASMUS+ project is to develop an online interactive course and underlying web-oriented platform, with the purpose of offering the smooth integration of Control Theory related content. A strategic partnership of four universities has been established to cover various aspects in project implementation (University of Ljubljana, Slovenia – Mechanical Engineering; University of Pisa, Italy – Manufacturing; University of Budapest, Hungary – Electrical Engineering and Robotics; and University of Rijeka, Croatia – Computer Engineering). During the development of the interactive course, an exchange of ideas and good practices has successfully taken place between all the stakeholders (students and teachers), who are from different countries and have different background knowledge.

The project addresses the challenges associated with the learning and teaching of Control Theory related topics and students' motivation to acquire knowledge from the corresponding interactive course. It also addresses the emerging need for distance learning and digital educational content creation due to the ongoing COVID-19 pandemic. The main project result is a web-based interactive course for learning Control Theory which allows students to actively interact with given systems and monitor their responses in real time. Students can also test their knowledge by solving exam questions. The interactive course is additionally supported by an accompanying textbook, which covers four main topics: the mathematical background, time domain, frequency domain, and state space. Both the content of the interactive course and the textbook are released under open-source licence. Project results are disseminated via various digital platforms, including LinkedIn, Github, Twitter, Reddit, and ResearchGate.



Co-funded by the  
Erasmus+ Programme  
of the European Union

**NAZIV PROJEKTA | PROJECT TITLE:**

**Promocija održivosti kao ključnog pokretača u obrazovanju za razvoj programske podrške**  
Promoting Sustainability As A Fundamental Driver In Software Development Training And Education

**Predlagatelj projekta**

dr. sc. João Paulo Fernandes,  
University of Coimbra, Informatics Engineering  
Department, Portugal

**Voditelj na partnerskoj instituciji**

dr. sc. Goran Mauša,  
Sveučilište u Rijeci, Tehnički fakultet

**Članovi tima**

Tehnički fakultet, Sveučilište u Rijeci  
doc. dr. sc. Sandi Ljubić

University of Amsterdam, Netherlands

dr. sc. Ana Oprescu  
dr. sc. Clemens Grelck

Technical University of Košice, Slovakia

dr. sc. Csaba Szabó  
dr. sc. Štefan Korečko  
dr. sc. Emília Pietriková

University of Plovdiv "Paisii Hilendarski",  
Bulgaria

dr. sc. Elena Somova  
dr. sc. Georgi Pashev

University of Minho, Portugal

dr. sc. Jácome Cunha  
dr. sc. João Saraiva  
dr. sc. Orlando Belo  
dr. sc. Rui Pereira

Babes-Bolyai University of Cluj-Napoca,  
Romania

dr. sc. Lehel Csato  
dr. sc. Zsuzsanna Onet-Mariann

University of Coimbra, Portugal

dr. sc. Luís Paquete

**Project proposer**

D. Sc. João Paulo Fernandes,  
University of Coimbra, Informatics Engineering  
Department, Portugal

**Head at a partner institution**

Goran Mauša, D. Sc.,  
University of Rijeka, Faculty of Engineering

**Team members**

Faculty of Engineering, University of Rijeka  
Assist. Prof. Sandi Ljubić, D. Sc.

University of Amsterdam, Netherlands

Ana Oprescu, D. Sc.  
Clemens Grelck, D. Sc.

Technical University of Košice, Slovakia

Csaba Szabó, D. Sc.  
Štefan Korečko, D. Sc.  
Emília Pietriková, D. Sc.

University of Plovdiv "Paisii Hilendarski",  
Bulgaria

Elena Somova, D. Sc.  
Georgi Pashev, D. Sc.

University of Minho, Portugal

Jácome Cunha, D. Sc.  
João Saraiva, D. Sc.  
Orlando Belo, D. Sc.  
Rui Pereira, D. Sc.

Babes-Bolyai University of Cluj-Napoca,  
Romania

Lehel Csato, D. Sc.  
Zsuzsanna Onet-Mariann, D. Sc.

University of Coimbra, Portugal

Luís Paquete, D. Sc.



Radboud University Nijmegen, Netherlands  
dr. sc. Mart Lubbers  
dr. sc. Pieter Koopman

Radboud University Nijmegen, Netherlands  
Mart Lubbers, D. Sc.  
Pieter Koopman, D. Sc.

Sveučilište Jurja Dobrile, Pula  
dr. sc. Tihana Galinac Grbac  
dr. sc. Neven Grbac  
dr. sc. Nikola Tanković  
dr. sc. Valter Boljunčić

University Juraj Dobrila, Pula, Croatia  
Tihana Galinac Grbac, D. Sc.  
Neven Grbac, D. Sc.  
Nikola Tanković, D. Sc.  
Valter Boljunčić, D. Sc.

Eötvös Loránd University, Hungary  
dr. sc. Viktória Zsók  
dr. sc. Zoltán Porkoláb

Eötvös Loránd University, Hungary  
Viktória Zsók, D. Sc.  
Zoltán Porkoláb, D. Sc.

### Sažetak projekta

Održivost, kao ključni pokretač razvoja modernog društva i budućnosti planeta, nikada nije postigla toliko konsenzusa u svijetu kao danas. U konačnici, hardver ICT sustava troši energiju, no softver upravlja tim hardverom. Stoga je upravljanje softverom ključno za smanjenje sve većeg energetske otiska ICT sustava. Održivi projekt zagovara uvođenje svih aspekata održivosti kao primarnu brigu u praksi softverskog inženjeringa.

Ovaj projekt ima za cilj promicanje obrazovanja sljedeće generacije softverskih inženjera koji će uzeti u obzir održivost u svim aspektima procesa softverskog inženjeringa: SusTrainable znači Obuka za održivost. Našim budućim softverskim inženjerima želimo pružiti bitne vještine za razvoj softvera koji je ne samo funkcionalno ispravan, već i jednostavan za održavanje i razvoj, koji je izdržljiv, ima mali utjecaj i koristi hardver na energetski najučinkovitiji način.

Naš cilj je osposobiti buduće avangardne softverske inženjere za održivi softver i ICT koje zahtijevaju društva temeljena na znanju, ekološki orijentirana u 21. stoljeću. Većina polaznika ljetnih škola blizu je prelaska s učenja na rad u inženjerskoj profesiji i uskoro će se pridružiti europskoj radnoj snazi softverskih inženjera. Ideje, koncepte i metode koje su naučili na ljetnim školama prenijet će u praksu industrijskog softverskog inženjeringa diljem Europe. Nadalje, oni će djelovati kao promotori koji će pronijeti koncepte održivosti u budućnosti upravljanja softverom. U tu svrhu okupljamo širok i raznolik konzorcij istraživača i nastavnika s 10 odabranih sveučilišta i 7 zemalja iz cijele Europe.

### Project summary

Sustainability as a key driver for the development of modern society and the future of the planet has never achieved as much consensus worldwide as today. Ultimately, it is the hardware of ICT systems that consumes energy, but it is software that controls this hardware. Thus, controlling the software is crucial to reducing the ever-growing energy footprint of ICT systems. The SusTrainable project advocates the introduction of all facets of sustainability as a primary concern into software engineering practice.

This project aims to actively promote educating the next generation of software engineers to consider sustainability in all aspects of the software engineering process: SusTrainable means Training for Sustainability. We aim to provide future software engineers with essential skills to develop software that is not only functionally correct, but also easy to maintain and evolve, that is durable, has a low impact and uses the hardware it is running on in the most energy-efficient way.

Our objective is to train the future avant-garde software engineers for the sustainable software and ICT that the knowledge-based, environmentally concerned societies of the 21st century demand. The majority of summer school participants are close to their transition from learning to doing, and will soon join the European software engineering workforce. They will carry the ideas, concepts and methods they have learned at the summer schools into industrial software engineering practice worldwide and across Europe. Furthermore, they will act as facilitators and multipliers alike for a sustainable future software-driven Europe. For this purpose, we have assembled a broad and diverse consortium of researchers and educators from 10 selected universities and 7 countries from across Europe.

### NAZIV PROJEKTA | PROJECT TITLE:

#### Primjena Hrvatskog kvalifikacijskog okvira za sveučilišne studijske programe u području elektrotehnike - HKO-ELE

Application of Croatian Qualification Framework for university study programmes in electrical engineering - HKO-ELE

#### Nositelj projekta

Fakultet elektrotehnike, računarstva i informacijskih tehnologija, Sveučilište u J. J. Strossmayera u Osijeku

#### Project leader

Faculty of Electrical Engineering, Computer Science and Information Technology, Josip Juraj Strossmayer University of Osijek

#### Partneri na projektu

Fakultet Elektrotehnike i računarstva, Sveučilište u Zagrebu

Tehnički fakultet, Sveučilište u Rijeci

Fakultet elektrotehnike, strojarstva i brodogradnje, Sveučilište u Splitu

Sveučilište u Dubrovniku

Hrvatska komora inženjera elektrotehnike

Hrvatska udruga poslodavaca

Društvo za oblikovanje održivog razvoja

#### Project partners

Faculty of Electrical Engineering and Computing, University of Zagreb

Faculty of Engineering, University of Rijeka

Faculty of Electrical Engineering, Mechanical Engineering and Naval Architecture, University of Split

University of Dubrovnik

The Croatian Chamber of Electrical Engineers

The Croatian Employers' Association

Society for Sustainable Development Design

#### Članovi projektnog tima na Tehničkom fakultetu

izv. prof. dr. sc. Neven Bulić - koordinator projektnih aktivnosti na Tehničkom fakultetu

prof. dr. sc. Saša Vlahinić

prof. dr. sc. Nino Stojković

izv. prof. dr. sc. Dubravko Franković

doc. dr. sc. Rene Prenc

Ana Šutalo

#### Members of project team at the Faculty of Engineering

Assoc. Prof. Neven Bulić, D. Sc. - coordinator of project activities at the Faculty of Engineering

Prof. Saša Vlahinić, D. Sc.

Prof. Nino Stojković, D. Sc.

Assoc. Prof. Dubravko Franković, D. Sc.

Assist. Prof. Rene Prenc, D. Sc.

Ana Šutalo

#### Sažetak projekta

Projekt „Primjena Hrvatskog kvalifikacijskog okvira u području elektrotehnike (HKO-ELE)“ uredit će sustav kvalifikacija u području elektrotehnike, uključujući informacijsku i komunikacijsku tehnologiju, na temelju Zakona o Hrvatskom kvalifikacijskom okviru (HKO) i metodologije propisane Pravilnikom o Registru HKO-a. Izradit će se standardi zanimanja i kvalifikacija i unaprijediti 14 studijskih programa u skladu s novom paradigmatom zasnovanom na ishodima učenja, za što će se nastavnici posebno educirati.

Projekt se provodi u okviru Poziva na dostavu projektnih prijedloga „Provedba HKO-a na razini visokog obrazovanja“ (referentni broj poziva: UP.03.1.1.03) financiranog iz Europskog socijalnog fonda, u trajanju od 36 mjeseci, odnosno od 22. 3. 2019. do 22. 3. 2022. godine.

#### Project summary

The “Application of Croatian Qualifications Framework for university study programmes in electrical engineering” project will contribute to the development of the qualifications framework in the field of electrical engineering, including information and communication technologies, based on the Croatian Qualifications Framework Act (CROQF), and on the methodology defined by the Ordinance on the CROQF Register. Occupational and qualifications standards will be developed and 14 study programmes enhanced, based on learning outcomes, and lecturers of partner institutions will be trained.

The project is being implemented as part of the “Implementation CROQF at the higher education level” call (call reference: UP.03.1.1.03), and is co-financed by the European Union from the European social fund and has a duration of 36 months, from 22.3.2019. to 22.3.2022.



**NAZIV PROJEKTA | PROJECT TITLE:**

**Dig IT - Izrada standarda zanimanja i standarda kvalifikacija u djelatnostima računarstva**  
DigIT - Development of occupational standards and qualification standards in computer science

**Nositelj projekta**

Fakultet elektrotehnike, strojarstva i brodogradnje, Sveučilište u Splitu

**Partneri na projektu**

Fakultet Elektrotehnike i računarstva, Sveučilište u Zagrebu  
Fakultet elektrotehnike, računarstva i informacijskih tehnologija, Sveučilište J. J. Strossmayera u Osijeku  
Tehnički fakultet, Sveučilište u Rijeci  
Sveučilište u Dubrovniku

**Članovi projektnog tima na Tehničkom fakultetu**

izv. prof. dr. sc. Ivan Štajduhar - koordinator projektnih aktivnosti na Tehničkom fakultetu  
doc. dr. sc. Sandi Ljubić  
doc. dr. sc. Goran Mauša

**Sažetak projekta**

Izradom standarda zanimanja i standarda kvalifikacija za zanimanja iz područja računarstva i tehničkih rješenja za povezivanje studijskih programa sa tržištem rada i gospodarstvom, povećat će se relevantnost navedenih studijskih programa, a jačanjem kompetencija nastavnika i stvaranjem odgovarajućeg institucionalnog i tehnološkog okvira unaprijedit će se nastavna djelatnost i kvaliteta studijskih programa svih partnera.

Projekt se provodi u okviru Poziva na dostavu projektnih prijedloga „Provedba HKO-a na razini visokog obrazovanja“ (referentni broj poziva: UP.03.1.1.03) financiranog iz Europskog socijalnog fonda, u trajanju od 36 mjeseci, odnosno od 22. 3. 2019. do 22. 3. 2022. godine.

**NAZIV PROJEKTA | PROJECT TITLE:**

**Nacionalni centri kompetencija u EuroHPC okviru - EuroCC**

National Competence Centres in the framework of EuroHPC - EuroCC

**Voditelj projektne komponente RITEH/UNIRI**

prof. dr. sc. Lado Kranjčević,  
Tehnički fakultet, Sveučilište u Rijeci

**Project leader**

Faculty of Electrical Engineering, Mechanical Engineering and Naval Architecture, University of Split

**Project partners**

Faculty of Electrical Engineering and Computing, University of Zagreb  
Faculty of Electrical Engineering, Computer Science and Information Technology, Josip Juraj Strossmayer University of Osijek  
Faculty of Engineering, University of Rijeka  
University of Dubrovnik

**Members of project team at the Faculty of Engineering**

Assoc. Prof. Ivan Štajduhar, D. Sc. - coordinator of project activities at the Faculty of Engineering  
Assist. Prof. Sandi Ljubić, D. Sc.  
Assist. Prof. Goran Mauša, D. Sc.

**Project summary**

The development of occupational standards and qualification standards for occupations in the field of computer science, as well as technical solutions for connecting study programmes with the labour market and the economy, will increase the relevance of these study programmes, whereas strengthening teachers' competencies and creating an appropriate institutional and technological framework will improve the teaching and quality of study programmes of all partners.

The project is being implemented as part of the Call for Proposals "Implementation of the CROQF at the level of higher education" (call reference number: UP.03.1.1.03) funded by the European Social Fund, lasting 36 months, from 22.3.2019 to 22.3.2022.

**Partnerski konzorcij iz Republike Hrvatske**

SRCE Zagreb – voditelj projektne komponente u RH

Tehnički fakultet Sveučilišta u Rijeci – partner,  
Sveučilište u Rijeci – partner,  
Institut Ruđer Bošković Zagreb – partner,  
FER Zagreb – partner,  
FESB Split – partner,  
FERIT Osijek – partner.

**Članovi istraživačkog tima s Tehničkom fakulteta Sveučilišta u Rijeci**

prof. dr. sc. Lado Kranjčević,  
izv. prof. dr. sc. Ivan Štajduhar  
doc. dr. sc. Jonatan Lerga  
doc. dr.sc. Goran Mauša  
asist. dr. sc. Luka Grbčić

**Sažetak projekta**

EuroCC aktivnost okupit će potrebnu stručnost za uspostavljanje mreže nacionalnih centara kompetencija u HPC-u širom Europe u 31 državi članici i pridruženim državama sudionicama kako bi se pružio širok portfelj usluga prilagođen odgovarajućim nacionalnim potrebama industrije, akademske zajednice i javne uprave. Sve ovo služi potpori i snažnom povećanju nacionalnih snaga kompetencija računarstva visokih performansi (HPC) kao i mogućnosti analize podataka visokih performansi (HPDA) i umjetne inteligencije (AI) i za zatvaranje postojećih praznina u povećanju upotrebljivosti ovih tehnologija u različitim državama čime će se osigurati izvrsnost europskih standarda.

**Partner consortium from RH**

University Computing Centre SRCE, Zagreb. – project component manager in the Republic of Croatia  
Faculty of Engineering, University of Rijeka – partner,  
UNIRI – partner,  
Ruđer Bošković Institute, Zagreb – partner,  
FER Zagreb – partner,  
FESB Split – partner,  
FERIT Osijek – partner.

**Members of the research team**

Prof. Lado Kranjčević, D. Sc.  
Assoc. Prof. Ivan Štajduhar, D. Sc.  
Assist. Prof. Jonatan Lerga, D. Sc.  
Assist. Prof. Goran Mauša, D. Sc.  
Assist. Luka Grbčić, D. Sc.

**Project summary**

This EuroCC activity will bring together the necessary expertise to set up a network of National Competence Centres in HPC across Europe in the 31 participating, member and associated states, to provide a broad service portfolio tailored to the respective national needs of industry, academia and public administrations. All of this is to support and greatly increase the national strengths of High Performance Computing (HPC) competences as well as High Performance Data Analytics (HPDA) and Artificial Intelligence (AI) capabilities, and to close existing gaps to increase the usability of these technologies in the different states and thus provide a European excellence baseline.

**NAZIV PROJEKTA | PROJECT TITLE:**

**Maritime Environment-friendly TRanspOrt systems – METRO 2014 - 2020 Interreg V-A Italy - Croatia CBC Programm**

Maritime Environment-friendly TRanspOrt systems – METRO 2014 - 2020 Interreg V-A Italy - Croatia CBC Programme

**Voditelj projekta**

prof. dr. sc. Roko Dejhalla, dipl. ing.,  
Tehnički fakultet, Sveučilište u Rijeci

**The head of the project**

Prof. Roko Dejhalla, D. Sc.  
Faculty of Engineering, University of Rijeka



**Članovi projektnog tima**

prof. dr. sc. Jasna Prpić-Oršić,  
Tehnički fakultet, Sveučilište u Rijeci  
prof. dr. sc. Albert Zamarin,  
Tehnički fakultet, Sveučilište u Rijeci  
asist. Davor Bolf,  
Tehnički fakultet, Sveučilište u Rijeci  
Darin Majnarić, stručni suradnik,  
Tehnički fakultet, Sveučilište u Rijeci  
Lino Josip Novak, stručni suradnik,  
Tehnički fakultet, Sveučilište u Rijeci  
Sara Volarić,  
Tehnički fakultet, Sveučilište u Rijeci  
(administrator)

**Sažetak projekta**

Projekt METRO je započeo 1. siječnja 2019. godine u sklopu programa prekogranične suradnje Interreg V-A Italija-Hrvatska 2014. - 2020. Unutar ovog programa fokus prioritetne osi 4 - Pomorski promet - je razvoj i unaprjeđenje prometnih sustava prihvatljivih za okoliš (uključujući one s niskom razinom buke) i prometni sustavi s niskom emisijom ugljičnog dioksida, uključujući unutarnje plovne putove i pomorski prijevoz, luke, multimodalne veze i infrastrukturu zračnih luka, radi promicanja održive regionalne i lokalne mobilnosti. Vodeći partner projekta je Sveučilište u Trstu dok su ostali partneri u projektu Lučka uprava Trst, Wärtasilä Italia S.p.A., Tehnomont brodogradilište Pula d.o.o., Sveučilište u Rijeci - Pomorski fakultet, Sveučilište u Rijeci - Tehnički fakultet i Istarska razvojna agencija - IDA d.o.o.

Razmatrajući s tehnološkog stajališta, jedan je od ciljeva projekta razvoj hibridnih brodova kratkog i srednjeg doplova. Pritom su od interesa Ro-Pax brod i trajekt s obostranim ukrcajno-iskrcajnim rampama koji su najčešći tipovi brodova za obalnu plovidbu na području Jadrana. Tehnički fakultet u Rijeci u projektu METRO sudjeluje u okviru radnog paketa „Hybrid vessels study and demonstrators“. Aktivnosti fakulteta posebno su vezane uz strukturu i hidrodinamiku trupa trajekta s obostranim ukrcajno-iskrcajnim rampama i Ro-Pax trajekta. Analiza strukture temeljena je na početnim proračunima strukture koje je izradilo Tehnomont brodogradilište Pula d.o.o. i u kojima su definirani strukturni elementi na središnjem presjeku oba broda. Na temelju tih podataka, na Tehničkom fakultetu definirani su i dimenzionirani i preostali dijelovi strukture prema pravilima klasifikacijskog društva Bureau Veritas. U cilju provođenja globalne analize čvrstoće strukture broda, pripremljeni su 3D strukturni modeli koji su potom uneseni u softver za analizu

**Members of the project team**

Prof. Jasna Prpić-Oršić, D. Sc.  
Faculty of Engineering, University of Rijeka  
Prof. Albert Zamarin, D. Sc.  
Faculty of Engineering, University of Rijeka  
Assist. Davor Bolf,  
Faculty of Engineering, University of Rijeka  
Darin Majnarić, Associate,  
Faculty of Engineering, University of Rijeka  
Lino Josip Novak, Associate,  
Faculty of Engineering, University of Rijeka  
Sara Volarić,  
Faculty of Engineering, University of Rijeka  
(administrator)

**Project summary**

The METRO project was started on 1 January 2019 as a part of the Italy-Croatia Interreg Cross-Border Cooperation Programme 2014-2020. As part of this programme, the focus of priority axis 4 - Maritime Transport - is developing and improving environmentally-friendly (including low noise) and low-carbon transport systems, including inland waterways and maritime transport, ports, multi-modal links and airport infrastructure, in order to promote sustainable regional and local mobility. The leading partner of the METRO project is the University of Trieste Department of Engineering and Architecture, while other partners are the Port Network Authority of the Eastern Adriatic Sea, Wärtasilä Italia S.p.A, Tehnomont Shipyard Pula Ltd, the University of Rijeka Faculty of Maritime Studies, the University of Rijeka Faculty of Engineering, and the Istrian Development Agency - IDA Ltd.

From a technological standpoint, one of the goals of the project is the development of hybrid short and medium-sized vessels. In this, Ro-Pax and double-ended ferries are of interest. These are the most common types of coastal vessel for passenger and vehicle transport in the Adriatic. The Faculty of Engineering in Rijeka is included in the project as part of the work package “Hybrid vessels study and demonstrators”.

The activities of the Faculty of Engineering in Rijeka specifically relate to the double-ended ferry and Ro-Pax vessel's hull structure and hydrodynamics. The structural analysis is based on the initial structure calculations made by Tehnomont Shipyard Pula Ltd, which defined the mid-ship section for both the double-ended ferry and RoPax vessel. Based on this, the rest of the structure was defined according to Bureau Veritas classification society rules. After the overall structure was defined, in order to analyse the structure, 3D structural models were

konačnim elementima (FEM). Provedeno je devet različitih globalnih analiza za trajekt s obostranim ukrcajno-iskrcajnim rampama i tri za Ro-Pax trajekt.

U okviru radnog paketa također su definirane značajke otpora i propulzije projektiranih brodova. Forme brodova koje su početno razvijene u Tehnomont brodogradilištu Pula d.o.o., analizirane su pomoću softvera za računarsku dinamiku fluida (CFD). Optjecanje vode oko trupa broda analizirano je i za umanjeni model broda i za brod u stvarnoj veličini, a dobiveni rezultati ukazuju na povoljne hidrodinamičke značajke forme. Nadalje, za oba su broda provedene i analize propulzijskih značajki, a iz dobivenih prognoznih dijagrama može se zaključiti da će oba broda s odabranim propulzijskim motorima moći postići predviđenu brzinu za plovidbu na odabranim rutama. Također su provedene i numeričke analize pomorstvenosti brodova, odnosno određene su značajke držanja brodova na valovima tijekom plovidbe na odabranim rutama. Iz provedenih analiza može se zaključiti da se kod oba broda tijekom plovidbe neće pojaviti značajnija gibanja na valovima zbog kojih bi se mogli ugroziti putnici ili vozila.

Glavni rezultat projekta METRO bit će poboljšana kvaliteta, sigurnost i ekološka održivost pomorskog prijevoza za turističke namjene na Sjevernom Jadranu, putem jačanja razmjene znanja između partnera iz industrije i akademskih partnera i jače integriranog okvira za usvajanje održivih oblika prijevoza.

prepared which were afterwards imported into the software for FEM analysis. Nine different global FEM analyses were run for the double-ended ferry and three for the Ro-Pax vessel.

Within the work package, the resistance and propulsion characteristics of the developed vessels were also determined. The hull forms developed by Tehnomont Shipyard Pula Ltd were analysed using software for computational fluid dynamics simulation. The vessels were analysed, both at the model and full-scale level, and the results indicate favourable hydrodynamic characteristics. Furthermore, for both developed vessels, analyses of propulsion characteristics were performed, and it can be concluded that both vessels with selected propulsion engines can achieve the predicted speed for navigation on selected routes. Numerical seakeeping analyses of both vessels were also performed in order to check the motions and responses of the vessels during voyages. From the performed analyses, it can be concluded that neither ship will experience significant peaks of motion during navigation which could endanger passengers or vehicles.

The main result of the METRO project will be the improved quality, safety and environmental sustainability of maritime transport for tourism purposes in the North Adriatic, achieved through enhancing knowledge sharing between industry and academic partners and a more integrated framework for adopting sustainable modes of transport.

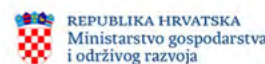
**NAZIV PROJEKTA | PROJECT TITLE:****Napredne metode i tehnologije u znanosti o podacima i kooperativnim sustavima - DATACROSS**

Advanced Methods and Technologies in Data Science and Cooperative Systems – DATACROSS

**Glavni istraživači**

prof. dr. sc. Zlatan Car,  
Tehnički fakultet, Sveučilište u Rijeci  
prof. dr. sc. Viktor Sučić,  
Tehnički fakultet, Sveučilište u Rijeci  
izv. prof. dr. sc. Kristijan Lenac,  
Tehnički fakultet, Sveučilište u Rijeci

**Principal investigators**

Prof. Zlatan Car, D. Sc.  
Faculty of Engineering, University of Rijeka  
Prof. Viktor Sučić, D. Sc.  
Faculty of Engineering, University of Rijeka  
Assoc. Prof. Kristijan Lenac, D. Sc.  
Faculty of Engineering, University of Rijeka

**Članovi istraživačkog tima**

Jelena Musulin,  
stručna suradnica – mlađa istraživačica,  
Tehnički fakultet, Sveučilište u Rijeci

**Members of the project team**

Jelena Musulin,  
Professional Associate – Junior Researcher,  
Faculty of Engineering, University of Rijeka

Domagoj Pinčić,  
stručni suradnik – mlađi istraživač,  
Tehnički fakultet, Sveučilište u Rijeci

Sandi Baressi Šegota,  
stručni suradnik – mlađi istraživač,  
Tehnički fakultet, Sveučilište u Rijeci

Daniel Štifanić,  
stručni suradnik – mlađi istraživač,  
Tehnički fakultet, Sveučilište u Rijeci

Domagoj Pinčić,  
Professional Associate – Junior Researcher,  
Faculty of Engineering, University of Rijeka

Sandi Baressi Šegota,  
Professional Associate – Junior Researcher,  
Faculty of Engineering, University of Rijeka

Daniel Štifanić,  
Professional Associate – Junior Researcher,  
Faculty of Engineering, University of Rijeka

### Sažetak projekta

DATA CROSS je projekt Znanstvenog centra izvrsnosti za znanost o podacima i kooperativnim sustavima koji se bavi istraživačkim problemima razvoja naprednih metoda i tehnologija analize heterogenih podataka te oblikovanja složenih kooperativnih sustava. Ciljevi projekta su:

- provedba istraživanja u područjima znanosti o podacima i kooperativnim sustavima,
- povećanje doprinosa razvoju hrvatskog gospodarstva i društva u cjelini,
- jačanje kapaciteta i povećanje međunarodne vidljivosti i prepoznatljivosti znanstvenog centra izvrsnosti u prethodno navedenim područjima.

Kroz DATA CROSS projekt su organizirane razne aktivnosti podijeljene kroz elemente kao što su napredne metode i tehnologije u znanosti o podacima i kooperativnim sustavima, nabava opreme, međunarodna suradnja, usavršavanje osoblja ZCI-a, promidžba i dr. Kroz DATA CROSS projekt se aktivno sudjeluje s gospodarstvom putem razvoja novih visokotehnoloških proizvoda i usluga, diseminacijske aktivnosti i osnivanje spin-off poduzeća.

U sporazumu o prijaviteljima projekta nalazi se i Tehnički fakultet Sveučilišta u Rijeci (RITEH). Kroz projekt, znanstvenici s RITEH-a bave se istraživanjem i razvojem metoda i tehnologija iz raznih polja, a jedno od njih je i primjena umjetne inteligencije. Umjetna inteligencija, zbog svojih brojnih mogućnosti, danas se smatra jednim od najaktivnijih i najzanimljivijih područja znanosti.

### Project summary

DATA CROSS is a project of the Centre of Research Excellence for Data Science and Advanced Cooperative Systems dealing with research problems of developing advanced methods and technologies for heterogeneous data analysis and complex cooperative system shaping. The main project goals are:

- to conduct top-level research in the fields of Data Science and Cooperative Systems,
- to increase the Centre's contribution to the development of the Croatian economy and society in general,
- to strengthen the capacity, and increase the international visibility and recognition of the Centre.

DATA CROSS project activities are organised in the following areas: advanced methods and technologies in Data Science and Cooperative Systems, procurement of equipment, international cooperation and networking, training and improvement of the Centre's staff, publicity, etc. The DATA CROSS project enables active participation in the economy through the development of new high-tech products and services, dissemination activities and the establishment of spin-off companies.

One of the project applicants is the Faculty of Engineering of the University of Rijeka (RITEH). Through the project, scientists from RITEH are engaged in research and development of methods and technologies from various fields, one of which is the application of artificial intelligence (AI). Artificial intelligence, due to its many possibilities, is considered one of the most active and interesting fields of science.

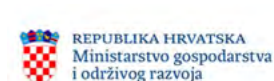

### NAZIV PROJEKTA | PROJECT TITLE:

#### Razvoj ekoloških proizvodnih procesa i novih proizvoda visoke kvalitete aktivnostima istraživanja i razvoja

Development of Ecological Production Processes and New Products of High Quality Through Research and Development Activities

#### Prijavitelj projekta

Feroplast d.o.o. Buje, Hrvatska

#### Project proposer

Feroplast d.o.o. Buje, Croatia

#### Partner u projektu

Tehnički fakultet, Sveučilište u Rijeci

#### Project partner

Faculty of Engineering, University of Rijeka

#### Lokalni koordinator

doc. dr. sc. Sandro Doboviček

#### Local coordinator

Assist. Prof. Sandro Doboviček, D. Sc.

#### Članovi tima s Tehničkog fakulteta

prof. dr. sc. Duško Pavletić

izv. prof. dr. sc. Marino Brčić

asist. Maja Vlatković

viša stručna suradnica Ivana Čabrijan

viši stručni suradnik Domagoj Vrtovšnik

#### Members of the project team

Prof. Duško Pavletić, D. Sc.

Assoc. Prof. Marino Brčić, D. Sc.

Assist. Maja Vlatković

Professional Associate Ivana Čabrijan

Professional Associate Domagoj Vrtovšnik

#### Sažetak projekta

Feroplast d.o.o. u partnerstvu sa Sveučilištem u Rijeci i Tehničkim fakultetom provodi projekt "Razvoj ekoloških proizvodnih procesa i novih proizvoda visoke kvalitete aktivnostima istraživanja i razvoja". Svrha projekta je povećanje konkurentnosti proizvodnje u Republici Hrvatskoj primjenom naprednih tehnologija, aktivnostima istraživanja i razvoja i uspostavom visokih standarda ekološke prihvatljivosti proizvodnje. Predmet projekta jest istraživanje koje će rezultirati spoznajama o mogućnostima značajnog unaprjeđenja proizvodnog procesa u ostvarenju ciljeva usmjerenih na ekološku prihvatljivost proizvodnje: produljenje životnog vijeka proizvoda, smanjenje potrošnje energije i emisije CO<sup>2</sup>, smanjenje potrošnje vode u proizvodnom procesu, smanjenje količine otpadnih voda razvojem nove proizvodne tehnologije. Očekivani ishodi projekta su: definiranje modela zavisnosti parametara proizvodnog procesa: tehnološkog postupka elektrootpornog zavarivanja i postupka antikorozijske zaštite, definiranje modela zavisnosti kvalitete zavara i antikorozijske trajnosti, uspostavljen mehanizam detekcije zavara i njihove klasifikacije vizualnim putem i mehanizam utvrđivanja antikorozijske trajnosti

#### Project summary

Feroplast d.o.o., in partnership with the University of Rijeka Faculty of Engineering, is implementing the project "Development of ecological production processes and new products of high quality through research and development activities". The purpose of the project is to increase the competitiveness of industrial production in the Republic of Croatia by applying advanced technologies, research activities and development, and establishing high standards of environmentally sustainable production. The subject of the project is research that will result in knowledge that will be able to significantly improve production processes in order to achieve goals aimed at environmentally friendly production: extending product lifecycles, reducing energy consumption and CO<sup>2</sup> emissions, reducing water consumption in the production process, and reducing wastewater in the development of new production technology. The expected outcomes of the project are defining the model of dependence of production process parameters: the technological process of electro-resistant welding and the corrosion protection process, defining the model of dependence of weld quality and anticorrosive durability, the established mechanism of weld



za svaki tip klasificiranog zavara – predikcija antikorozivne trajnosti s obzirom na izgled zavara s nepromijenjenom varijablom površinske zaštite. Očekivano povećanje antikorozivne trajnosti proizvoda sa 500 na 600 sati prama standardu ISO 9227 ili ISO 6270 kroz regulaciju svih parametara u oba procesa (elektrootporno zavarivanje i elektrostatska plastifikacija) – povećanje antikorozivne zaštite za 20%.

detection and its classification - prediction of corrosion resistance with respect to the appearance of welds with an unchanged surface protection variable. The expected increase of anti-corrosion durability of products is from 500 to 600 hours according to ISO 9227 or ISO 6270 standards through regulation of all parameters in both processes (resistance welding and electrostatic plasticisation), an increase in anti-corrosion protection of 20%.



#### NAZIV PROJEKTA | PROJECT TITLE:

#### Računalni model strujanja, poplavlivanja i širenja onečišćenja u rijekama i obalnim morskim područjima - KLIMOD

A Computational Model of Flow, Flooding and Pollution Dispersion in Rivers and Coastal Marine Areas – KLIMOD

#### Voditelj projekta

prof. dr. sc. Lado Kranjčević,  
Tehnički fakultet, Sveučilište u Rijeci

#### Project leader

Prof. Lado Kranjčević, D. Sc.  
Faculty of Engineering, University of Rijeka

#### Partnerski konzorcij

Tehnički fakultet Sveučilišta u Rijeci – prijavitelj,  
Prirodoslovno-matematički fakultet, Geološki  
odsjek, Sveučilište u Zagrebu – partner,  
Institut Ruđer Bošković – partner,  
Medicinski fakultet Rijeka – partner,  
Građevinski fakultet Rijeka – partner.

#### Partner consortium

Faculty of Engineering University of Rijeka –  
lead partner,  
Faculty of Science - Department of Geology,  
University of Zagreb UNIZG – partner,  
Ruđer Bošković Institute – partner,  
Faculty of Medicine University of Rijeka –  
partner,  
Faculty of Civil Engineering University of Rijeka  
– partner.

#### Članovi istraživačkog tima s Tehničkog fakulteta Sveučilišta u Rijeci

prof. dr. sc. Siniša Družeta,  
Tehnički fakultet, Sveučilište u Rijeci  
doc. dr. sc. Goran Mauša,  
Tehnički fakultet, Sveučilište u Rijeci  
asist. dr. sc. Luka Grbčić,  
Tehnički fakultet, Sveučilište u Rijeci  
asist. Ivana Lučin,  
Tehnički fakultet, Sveučilište u Rijeci  
asist. Marta Alvir,  
Tehnički fakultet, Sveučilište u Rijeci

#### Members of the research team from the Faculty of Engineering University of Rijeka

Prof. Siniša Družeta, D. Sc.  
Faculty of Engineering, University of Rijeka  
Assist. Prof. Goran Mauša, D. Sc.  
Faculty of Engineering, University of Rijeka  
Assist. Luka Grbčić, D. Sc.  
Faculty of Engineering, University of Rijeka  
Assist. Ivana Lučin,  
Faculty of Engineering, University of Rijeka  
Assist. Marta Alvir,  
Faculty of Engineering, University of Rijeka

#### Sažetak projekta

Provedbom projekta provode se primijenjena znanstvena istraživanja i razvija se računalni model za učinkovito modeliranje strujanja i širenja onečišćenja u otvorenim vodotocima i obalnom morskom području, s prihvatom riječnih utoka, bujičnih utoka te industrijskih i kanalizacijskih ispusta u obalno morsko područje, uz istodobni razvoj predikcijskog modela mikrobiološkog onečišćenja baziranog na modelima umjetne inteligencije i integraciju modela širenja onečišćenja mikroplastikom u ukupni model. Računalni model prilagođen je superračunalnom okruženju što omogućuje provođenje simulacija visoke rezolucije s ciljem provođenja mjera za ublažavanje posljedica klimatskih promjena na prioritetnim ranjivim i transverzalnim područjima.

#### Project summary

The project implements applied scientific research and develops a computational model for effective modelling of flow and pollution dispersion in open watercourses and coastal sea areas, with the inclusion of river inflows, torrents and industrial and sewage discharges into the coastal sea area, while simultaneously developing a predictive model of microbiological pollution based on artificial intelligence models and the integration of microplastic pollution spread models into the overall model. The computational model is adjusted to the supercomputing environment, which enables the implementation of high-resolution simulations with the aim of implementing measures to mitigate the effects of climate change in priority vulnerable and transversal areas.



#### NAZIV PROJEKTA | PROJECT TITLE:

#### ABsistemDCiCloud

ABsistemDCiCloud

#### Članovi istraživačkog tima

doc. dr. sc. Jonatan Lerga,  
Tehnički fakultet, Sveučilište u Rijeci  
asist. David Bačnar,  
Tehnički fakultet, Sveučilište u Rijeci  
asist. Ana Vranković Lacković,  
Tehnički fakultet, Sveučilište u Rijeci  
asist. Luka Batistić,  
Tehnički fakultet, Sveučilište u Rijeci

#### Members of the research team

Assist. Prof. Jonatan Lerga, D. Sc.,  
Faculty of Engineering, University of Rijeka  
Assist. David Bačnar,  
Faculty of Engineering, University of Rijeka  
Assist. Ana Vranković Lacković,  
Faculty of Engineering, University of Rijeka  
Assist. Luka Batistić,  
Faculty of Engineering, University of Rijeka

#### Sažetak projekta

Ovaj je projekt financiran iz Europskog fonda za regionalni razvoj (program OP Konkurentnost i kohezija - Jačanje gospodarstva primjenom istraživanja i razvoja) kroz poziv Povećanje razvoja novih proizvoda i usluga koji proizlaze iz aktivnosti istraživanja i razvoja – faza II. Sam projekt je znanstvenoistraživačkog karaktera i koncipiran kroz dvije faze istraživanja: industrijsko istraživanje i eksperimentalni razvoj. Cilj projekta je razvoj softvera za centralizaciju i integraciju tehničke zaštite koji će omogućavati nadzor i upravljanje svim integriranim sustavima putem jedinstvenog sučelja. Sustav će se najčešće ugrađivati u veće i kompleksnije objekte trgovinskog, financijskog, industrijskog, hotelskog i poslovnog sektora.

#### Project summary

This project is funded by the European Regional Development Fund (OP Competitiveness and Cohesion Program - Strengthening the economy through research and development) through the call Increasing the development of new products and services arising from research and development activities - Phase II. The project itself has a scientific-research character, which is planned in two research phases: industrial research and experimental development.

The aim of the project is to develop a software for the centralisation and integration of technical protection, which will allow the monitoring and management of all integrated systems through a single interface. The system will be installed mainly in larger and more complex facilities in



Provedbom predviđenih aktivnosti kreirat će se inovativni, višenamjenski i višefunkcionalni proizvod koji će, osim tehničke zaštite objekta (video nadzor, protuprovalna zaštita, vatrodojavni alarm, itd.), pružati i druge funkcionalnosti iz područja povećanja energetske učinkovitosti objekata. Razvijen sustav bit će modularan, a podaci će se pohranjivati u oblaku bez potrebe za postavljanjem lokalnih poslužitelja u objektima.

the commercial, financial, industrial, hotel and business sectors.

The implementation of the planned activities will result in an innovative, multi-purpose and multifunctional product that, in addition to the technical protection of the facility (video surveillance, anti-thief protection, fire alarm, etc.), will offer other functionalities in the field of increasing energy efficiency. The developed system will be modular, and the data will be stored in a cloud without the need to install local servers in the facilities.



#### NAZIV PROJEKTA | PROJECT TITLE:

**YUFERING - YUFE Transforming R&I Through Europe-Wide Knowledge Transfer**

YUFERING - YUFE Transforming R&I Through Europe-Wide Knowledge Transfer

#### Koordinator projekta

Sveučilište u Cipru

#### Project coordinator

University of Cyprus

#### Lokalni koordinator

prof. dr. sc. Saša Zelenika,  
Tehnički fakultet, Sveučilište u Rijeci

#### Local coordinator

Prof. Saša Zelenika, D. Sc.,  
Faculty of Engineering, University of Rijeka

#### U partnerstvu s institucijama iz zemalja:

Belgija, Cipar, Finska, Hrvatska, Italija,  
Nizozemska, Njemačka, Poljska, Španjolska i  
UK.

#### In partnership with

Belgium, Croatia, Cyprus, Finland, Germany,  
Italy, the Netherlands, Poland, Spain and the  
UK.

#### Sažetak projekta

Projektom u sklopu EU Obzor 2020 instrumenta "Support for the Research and Innovation Dimension of European Universities" nastoji se transformirati područje istraživanja i inovacija, a kroz promociju društveno odgovorne znanosti, kroz uključivanje praksi otvorene znanosti, poticanje cirkulacije znanja i mozgova, jačanje suradnje akademske zajednice i poslovnog svijeta i kroz razvoj globalnog istraživačkog ekosustava. Projekt doprinosi ostvarenju vizije Europske komisije o povećavanju međunarodne konkurentnosti sveučilišta u Europi kroz stvaranje sveučilišnih saveza, tzv. "Europskih sveučilišta". Cilj je omogućiti postojećim savezima, osnovanima kroz Erasmus+ pilot natječaj, povezivanje i razvoj u području znanosti i inovacija. Kroz projekt će se analizirati postojeće stanje na partnerskim sveučilištima YUFE saveza u područjima poput društveno odgovorne znanosti i inovacija, transfera znanja, planova razvoja znanosti i inovacija, istraživačkih

The project is taking place within the framework of the EU Horizon 2020 scheme "Support for the Research and Innovation Dimension of European Universities" which fosters the transformation of research and innovation via the promotion of socially responsible science, and by encompassing open science practices, encouraging brain and knowledge circulation, boosting the cooperation of the academic sector with business, as well as through the development of the global research ecosystem. The project contributes to the EC vision of enhancing the international competitiveness of single European universities by creating "European university alliances". The goal is to enable existing alliances, formed through an Erasmus+ pilot call, to network and develop further their R&I capacities. The state of play at the partner universities of the YUFE alliance will be analysed through the project in areas related to socially engaged research and

infrastruktura, otvorene znanosti i razvoja karijera znanstvenika te stvoriti zajedničke razvojne strategije u navedenim područjima. Namjera je ostvariti dodatno umrežavanje sveučilišta – članica YUFE saveza, a koje je usklađeno s već započetim povezivanjem u području obrazovanja. U YUFERING projektu, YUFE partneri će također raditi i na procjeni pravnih, regulatornih i financijskih uvjeta relevantnih za stvaranje jačeg europskog istraživačkog područja, a kroz koje će se utvrditi preporuke za željenu transformaciju kako bi dijeljenje resursa i kapaciteta bilo moguće, ali i privlačno za akademske i institucionalne/privatne ulagače i istraživače.

U provedbu projekta, kao povezana treća strana Sveučilišta, uključen je Tehnički fakultet u Rijeci i to posebno u aktivnosti u radnom paketu "YUFE as a catalyst for flipped knowledge transfer and deployment in society" (YUFE kao katalizator za obrnuti transfer znanja i implementaciju u zajednicu).

innovation, knowledge transfer, planning of R&I developments, research infrastructure, open science, and the fostering of academic careers so as to create joint strategies in these areas. The intention is to foster the networking of YUFE alliance partners already being set up in the field of education. In the YUFERING project, the YUFE partners will also work on the evaluation of the legal, regulatory and financial frameworks relevant to boosting the European Research Area (ERA), which will allow the defining of a set of recommendations for the transformation towards a sharing of resources and capacities so as to make them attractive to academic and institutional/private investors and researchers.

The Faculty of Engineering is actively involved in the execution of YUFERING project activities as a third party connected to the University of Rijeka, especially within the framework of the work package "YUFE as a catalyst for flipped knowledge transfer and deployment in society".

## 2.8 AKTIVNOSTI, ZBIVANJA I KONFERENCIJE

### ACTIVITIES, EVENTS AND CONFERENCES

#### 2.8.1 JOB.FAIR I DAN OTVORENIH LABORATORIJA 2020

##### JOB.FAIR AND OPEN LAB DAY 2020



Na Tehničkom fakultetu u Rijeci od 2017. godine redovno se održava manifestacija Sajam poslova – Job.Fair, a od 2012. godine Dani otvorenih laboratorija. Dani otvorenih laboratorija osmišljeni su kao posjet učenika srednjih škola Primorsko-goranske i susjednih županija laboratorijima Tehničkog fakulteta, gdje se učenici mogu upoznati s nastavnim, praktičnim i znanstvenim metodama karakterističnim za Tehnički fakultet i tehničke znanosti. Pojava virusa COVID-19 onemogućila je održavanje Sajma poslova i Dana otvorenih laboratorija na konvencionalan način. Stoga je osmišljen i realiziran projekt virtualnog Job.Faira i Dana otvorenih laboratorija na Tehničkom fakultetu, putem internet platforme, na poveznici

<https://fest.riteh.hr>

Na istoj poveznici ujedno je prikladno obilježena i šezdeseta godina postojanja i djelovanja Tehničkog fakulteta u Rijeci te su sve tri manifestacije prigodno povezane u jednu cijelinu – RITEH FEST. Održavanje Sajma poslova i Dana otvorenih laboratorija u virtualnom okruženju omogućilo je posjetiteljima virtualnu šetnju prostorijama i laboratorijima Tehničkog fakulteta korištenjem 360° panoramskim snimkama. Posjetitelji mogu pregledati videosnimke pokaznih laboratorijskih vježbi.

Job.Fair manifestacija održavala se u razdoblju od 2. do 6. studenog 2020. godine. Prijavilo se 22 poslodavca: A1, Aitac, Assecos SEE, BAT Adria, Croz d.o.o., Crossvallia, Danieli Systec, Elcon Geraetebau d.o.o., Elektroprojekt d.d., Eidos.hr (Gruppo Euris – Italy), Hops d.o.o., IHC Engineering Croatia d.o.o., Inetec d.o.o., Inmel d.o.o., iOLAP, Klimaoprema d.d., Mireo d.d., PK

At the Faculty of Engineering in Rijeka, Job.Fair events have been held regularly since 2017, and Open Laboratories Days since 2012. Open Laboratories Days are designed as a visit of high school students from Primorje-Gorski Kotar and neighbouring counties to the laboratories of the Faculty of Engineering, where students can get acquainted with the teaching and practical and scientific methods which are characteristic of the Faculty of Engineering and Technical Sciences. The appearance of the COVID-19 virus made it impossible to hold the Job Fair and Open Laboratories Days in a conventional way. Therefore, the project of a virtual Job.Fair and Open Laboratories Days at the Faculty of Engineering was designed and implemented via an internet platform at:

<https://fest.riteh.hr>

At the same link, the sixtieth year of existence and work of the Faculty of Engineering in Rijeka was appropriately marked, and all three events were conveniently connected into one whole – RITEH FEST. Holding the Job Fair and Open Laboratories Days in a virtual environment was performed in such a way that visitors could virtually walk around the premises and laboratories of the Faculty of Engineering, which was possible using 360° panoramic images, and view videos of demonstration laboratory exercises.

The Job.Fair event ran from 2-6 November 2020. 22 employers applied: A1, Aitac, Assecos SEE, BAT Adria, Croz doo, Crossvallia, Danieli Systec, Elcon Geraetebau doo, Elektroprojekt dd, Eidos.hr (Gruppo Euris - Italy), Hops doo, IHC Engineering Croatia doo, Inetec doo, Inmel doo, iOLAP, Klimaoprema dd, Mireo dd, Pk - Palfinger



- Palfinger kran d.o.o., Span, Tsi d.o.o., Uljanik Tesu Elektronika d.o.o. i Visage Technologies.

Za svakog od prijavljenih poslodavaca pripremljen je informativni letak i podstranica s dodatnim informacijama o poslodavcu. Uz to su neki poslodavci organizirali i interaktivnu komunikaciju sa zainteresiranim studentima. Job.Fair manifestacija zabilježila je 3201 posjetitelja, odnosno 7041 posjeta online stranicama manifestacije.

Manifestacija Dani otvorenih laboratorija trajala je dva tjedna, od 16. do 27. studenog 2020. godine. U Danima otvorenih laboratorija sudjelovalo 8 od 11 zavoda Tehničkog fakulteta, odnosno 15 od 49 laboratorija i RITEH Racing Team. Ukupno je realizirano 17 pokaznih mjesta s 41 pokaznom vježbom te 36 videosnimki (preko sat vremena snimljenog videomaterijala).

DOL manifestacija zabilježila je 4011 posjetitelja, odnosno 5729 posjeta online stranicama manifestacije. RITEH FEST manifestacija sveukupno je u studenom mjesecu 2020. godine zabilježila 8169 jedinstvenih posjetitelja i 14827 posjeta.

kran doo, Span, Tsi doo, Uljanik Tesu Elektronika doo, Visage Technologies.

An information leaflet and also a page with additional information about the employer were prepared for each of the registered employers. Additionally, certain employers also organised interactive communication for interested students. During this period, the Job.Fair event received 3,201 visitors and 7,041 visits to the online pages of the event.

The Open Laboratories Days event lasted for two weeks, from 16 to 27 November 2020. 8 out of 11 departments of the Faculty of Engineering, and 15 out of 49 laboratories, as well as the RITEH Racing Team, participated in the Open Laboratories Days. A total of 17 demonstration sites were created, with 41 demonstration exercises and 36 video recordings (representing over an hour of recorded video material).

During this period, the Open Laboratories Days event received 4,011 visitors and 5,729 visits to the event's online website. In total, the RITEH FEST event recorded 8,169 unique visitors and 14,827 visits during November 2020.

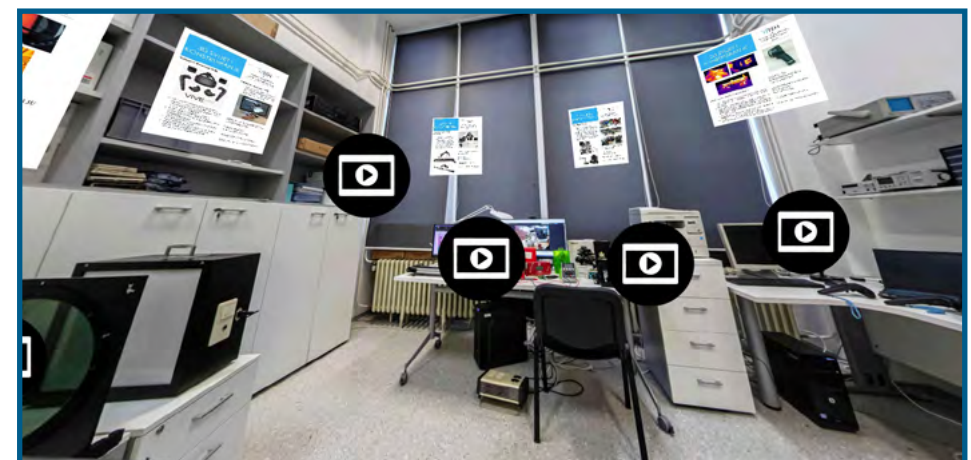



## 2.8.2 MY FIRST CONFERENCE 2021

Peto izdanje doktorske konferencije My First Conference održano je na Pomorskom fakultetu 23. rujna 2021. godine, u suradnji Tehničkog, Pomorskog i Građevinskog fakulteta. Pri tome je prezentirano 30 radova doktoranda, uz tri plenarna i jedno uvodno predavanje netom diplomiranih doktora znanosti. Kako su ove godine sudjelovali i autori iz Slovenije, Italije, Njemačke, Poljske i Irana, konferencija je imala međunarodni karakter.

Rezultati znanstvenih istraživanja doktoranda prezentiranih na konferenciji pokazali su praeenje modernih trendova i trenutno zastupljene tematike u akademskim i istraživačkim svjetskim krugovima u području tehničkih znanosti. Doktorandi su pokazali samoinicijativnost, kreativnost i samostalnost u istraživanjima, svestranost i interdisciplinarnost doktorskih studija, kao i visoku razinu kvalitete.

Sažeci radova su objedinjeni u zbornik sažetaka, a autori istaknutih predavanja bit će pozvani da svoje radove dostave u prateće časopise konferencije: Pomorstvo, Engineering review i Sustainability.

The fifth edition of the doctoral conference My First Conference was held at the Faculty of Maritime Studies on 23 September 2021 in cooperation with the Faculty of Engineering, Faculty of Maritime Studies, and Faculty of Civil Engineering. Students presented 30 papers, and there were three plenary and one introductory lecture by newly graduated doctors of science. As authors from Slovenia, Italy, Germany, Poland and Iran also participated this year, the conference had an international character.

The results of scientific research presented at the conference showed that doctoral research follows modern trends and topics currently represented in academic and research circles in the field of technical sciences. Doctoral students showed their self-initiative, creativity and independence in research, reflecting the versatility and interdisciplinarity of doctoral studies, as well as their high level of quality.

The abstracts are compiled as a book, and the authors of highlighted lectures invited to submit their papers to the supporting journals of the conference: Scientific Journal of Maritime Research, Engineering Review and Sustainability.



# MFC

## 5th My First Conference

PhD Conference on Engineering and Technology

MFC

Conference Topics & Scope

Organizers & Committees

Program

Publications

Venue

Important Dates

Login/Registration

Contact us

Previous Conferences



## 2.8.3 24. SIMPOZIJ SORTA

### 24<sup>th</sup> SORTA SYMPOSIUM



Simpozij SORTA dugi je niz godina najznačajniji znanstveni skup brodograđevnih, brodograđevnih i inženjera morskih tehnologija, ali i ostalih stručnjaka i znanstvenika vezanih za projektiranje, gradnju i korištenje brodova, pomorskih objekata i brodske opreme, s redovitim pokroviteljstvom HAZU.

24. Simpozij Teorija i praksa brodogradnje in memoriam prof. Leopold Sorta održan je online, od 15. do 16. listopada 2020. g. u organizaciji Tehničkog fakulteta u Rijeci, sa organizacijskom odborom: Marko Hadjina (pred.), Boris Ljubenković, Anton Turk, Dunja Legović, Tin Matulja, Ozren Bukovac, Davor Bolf and Joško Parunov. Radni dio započeo je pozvanim predavanjima istaknutih znanstvenika i stručnjaka iz relevantnih područja. Simpozij se nastavio izlaganjima radova, primarno iz područja Osnivanje broda i specijalnih objekata, Mala brodogradnja i plovni objekti unutarnjih voda, Organizacija i ekonomija brodograđevne industrije, Tehnologija, materijali, zaštita i održavanje, Brodsko strojarstvo, elektrotehnika, automatizacija i oprema broda, Brodska hidrodinamika, pomorstvenost i upravljivost, Čvrstoća, vibracije i konstrukcija broda, Morska tehnologija i zaštita okoliša i napredni brodograđevni softveri.

Na simpoziju je bilo registrirano više od 150 autora i sudionika sa 37 radova. Održane su 42 online prezentacije s prosječnom nazočnosti 70 sudionika. Simpozij SORTA2020 zaključen je svečanim zatvaranjem na kojem su svim sudionicima prezentirani rezultati simpozija, a svi radovi i pozvana predavanja simpozija objavljeni su u online Zborniku radova 24. Simpozija Teorija i praksa brodogradnje in memoriam prof. Leopold Sorta.

Simpozij SORTA2020 ispunio je svoj osnovni cilj: doprinijeti osnaživanju suradnje brodograđevne struke, gospodarstva, znanosti i visokog školstva iz Hrvatske i inozemstva s kvalitetnim, suvreme-

For many years, the SORTA Symposium has been the most important scientific gathering of shipbuilding, ship engineering and marine technology engineers, as well as other experts and scientists involved in the design, construction and use of ships, maritime facilities and ship equipment, regularly receiving the sponsorship of the Croatian Academy of Sciences and Arts.

The 24th Symposium on the Theory and Practice of Shipbuilding in memory of Professor Leopold Sorta, was held online from 15 to 16 October 2020, organised by the Technical Faculty in Rijeka and Organizing committee: Marko Hadjina (chair), Boris Ljubenković, Anton Turk, Dunja Legović, Tin Matulja, Ozren Bukovac, Davor Bolf and Joško Parunov, and began its work with invited lectures given by prominent scientists and experts from relevant fields. The symposium continued with presentations of papers in the following fields: ship and special facilities design; small shipbuilding and inland waterway vessels; the organisation and economics of the shipbuilding industry; technology, materials, protection and maintenance; ship engineering, electrical engineering, automation and ship equipment; ship hydrodynamics, seaworthiness and manoeuvrability; the strength, vibration and construction of ships; marine technology and environmental protection; advanced shipbuilding software.

More than 150 authors and participants, with 37 papers, registered for the symposium, and a total of 42 online presentations were held, with an average attendance of 70 participants. The SORTA2020 symposium concluded with a closing ceremony at which participants were presented with the results of the symposium, while all the papers and lectures were published in the online Proceedings of the 24th Symposium on the Theory and Practice of Shipbuilding in memory of Professor Leopold Sorta.

nim i globalno relevantnim sadržajima. Simpozij je doprinio i dodatnom prepoznavanju važnosti i potencijala brodograđevne struke i znanosti, odnosno broda, pomorskih objekata i morskih tehnologija kao interdisciplinarnog područja i tako pozitivno utjecao na interes za STEM područje u cjelini.

The SORTA2020 Symposium has fulfilled its main goal, which is to contribute to strengthening cooperation in the shipbuilding profession, economy, science and higher education in Croatia and abroad with high-quality, modern and globally relevant content. The symposium also contributed to the further recognition of the importance and potential of the shipbuilding profession and science, and also ship, maritime facilities and marine technologies as an interdisciplinary field, and thus positively influenced interest in the STEM field as a whole.



University of Rijeka  
FACULTY OF ENGINEERING



## 2.8.4 GNSS KONFERENCIJA 2021

### GNSS CONFERENCE 2021

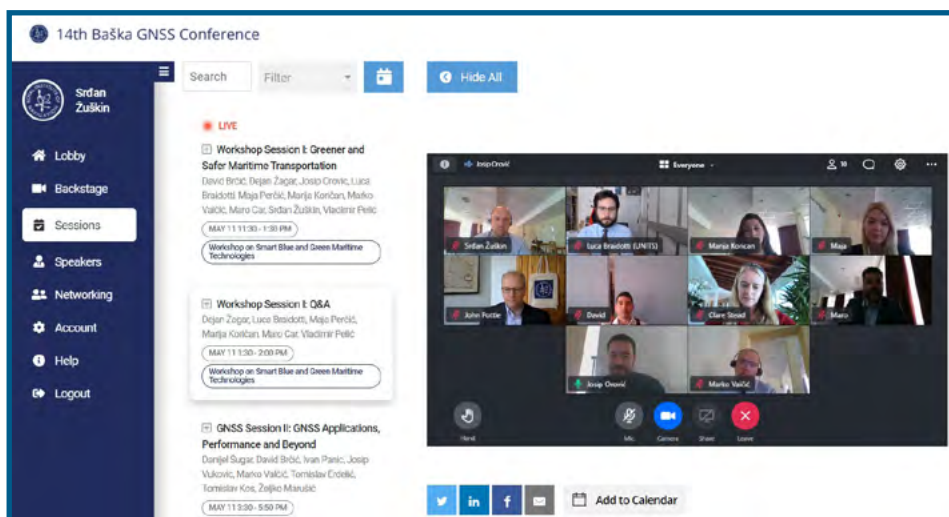

Tehnički fakultet u Rijeci sudjelovao je u organizaciji i provedbi 14. konferencije "Baška GNSS Conference", održanoj u Baški na otoku Krku, od 10. do 12. svibnja 2021. godine. Tradicionalnu konferenciju o satelitskoj navigaciji i ostalim morskim tehnologijama zajednički organiziraju Kraljevski institut za navigaciju (The Royal Institute of Navigation) iz Londona, Pomorski i Tehnički fakultet Sveučilišta u Rijeci i Fakultet prometnih znanosti Sveučilišta u Zagrebu.

Otvorenju skupa nazočili su i pozdravili sve prisutne: prof. dr. sc. Snježana Prijic-Samaržija, rektorica Sveučilišta u Rijeci, gosp. Toni Juranić, načelnik Općine Baška, izv. prof. dr. sc. Vlado Frančić, prodekan za stručno usavršavanje i razvoj Pomorskog fakulteta u Rijeci, prof. dr. sc. Duško Pavletić, dekan Tehničkog fakulteta u Rijeci i prof. dr. sc. Tomislav Josip Mlinarić, dekan Fakulteta prometnih znanosti u Zagrebu. Nakon pozdravnih govora, direktor Kraljevskog instituta za navigaciju, gosp. John R. Pottle, službeno je otvorio skup.

Ovogodišnja je konferencija imala posebnu konotaciju iz više razloga. Nakon prošlogodišnje pauze uslijed zatvaranja zbog globalne pandemije, a s obzirom na i dalje prisutne mjere na globalnoj razini, skup je održan korištenjem više komunikacijskih online platformi, u hibridnoj kombinaciji s djelomičnim održavanjem i u hotelu Corinthia u Baški. Kao i za svaki događaj ovakve hibridne vrste, organizacija i održavanje bili su prepuni izazova, no skup je proveden na nivou, kvalitetno i bez većih problema.

Također, ove godine je, u sklopu skupa, konač-

The Faculty of Engineering of the University of Rijeka helped to organise and also participated in the 14th Baška GNSS Conference, held in Baška on the island of Krk from 10 to 12 May 2021. The annual conference on satellite navigation and other maritime technologies is jointly organised by the Royal Institute of Navigation in London, the Faculty of Maritime Studies and Faculty of Engineering of the University of Rijeka, and the Faculty of Transport and Traffic Sciences of the University of Zagreb.

The opening of the meeting was attended by Professor Snježana Prijic-Samaržija, Rector of the University of Rijeka, Mr Toni Juranić, Mayor of Baška, Associate Professor Vlado Frančić, Vice Dean for Professional Development of the Faculty of Maritime Studies in Rijeka, Professor Duško Pavletić, Dean of the Faculty of Engineering in Rijeka, and Professor Tomislav Josip Mlinarić, Dean of the Faculty of Transport and Traffic Sciences in Zagreb, who welcomed participants. After the welcome speeches, the Director of the Royal Institute of Navigation, Mr John R Pottle, officially opened the conference.

This year's conference was significant for several reasons. After last year's break due to the lockdown caused by the global pandemic, and given the measures in place globally, the gathering was held using several online communication platforms in combination with a physical event at the Hotel Corinthia in Baška. Like every hybrid event of this kind, the organisation and holding of the conference presented challenges, but the gathering was a

no održana i prva radionica na temu pametnih, plavih i zelenih tehnologija u pomorstvu, koju je vodila prof. dr. sc. Jasna Prpić-Oršić s Tehničkog fakulteta Sveučilišta u Rijeci, inače i suvoditeljica cijele konferencije. Za organizaciju konferencije na lokalnoj razini ponajviše su se pobrinuli doc. dr. sc. David Brčić, suvoditelj konferencije s Pomorskog fakulteta u Rijeci i izv. prof. dr. sc. Marko Valčić, suvoditelj konferencije s Pomorskog odjela Sveučilišta u Zadru, donedavno djelatnik, a trenutno i vanjski suradnik Tehničkog fakulteta Sveučilišta u Rijeci.

Tijekom skupa, 22 istraživača izložila su rezultate svojih istraživanja. Održane su po dvije specijalističke sekcije u sklopu konferencije, odnosno radionice. Skupu je prisustvovalo sedamdesetak sudionika. Uz specijalističke sekcije, održano je osam pozvanih predavanja eminentnih svjetskih stručnjaka i znanstvenika iz područja satelitske navigacije i novih pomorskih tehnologija. Nakon svake sekcije održane su virtualne rasprave s predavačima i zainteresiranim sudionicima, što se pokazalo izvrsnim načinom komunikacije i daljnjeg umrežavanja. Rezultati bi već mogli ugledati svjetlo dana dogodine, na istom mjestu, u približno isto vrijeme.

high-quality one and passed without any major issues.

This year's conference at last saw the first workshop on smart, blue and green maritime technologies, which was led by Professor Jasna Prpić-Oršić of the Faculty of Engineering of the University of Rijeka, who was also the co-chair of the conference. The organisation of the conference at the local level was mostly taken care of by Assistant Professor David Brčić of the Faculty of Maritime Studies in Rijeka, who was also co-chair of the conference, and Associate Professor Marko Valčić of the Maritime Department of the University of Zadar, until recently a member of staff and currently an external associate of the Faculty of Engineering of the University of Rijeka, who was the other conference co-chair.

During the conference, 22 researchers presented the results of their research. Two specialist sections were held as part of the conference, and an additional two specialist sections were held as workshops. The gathering was attended by about 70 participants. In addition to the specialist sections, eight invitation/plenary lectures were given by international experts and researchers in the field of satellite navigation and new maritime technologies. After each section, virtual discussions were held with lecturers and interested participants, which proved to be an excellent opportunity for communication and further networking. Hopefully, the results might be seen as early as next year in the same place and at about the same time.



## 2.8.5 29<sup>th</sup> SUMMER SCHOOL ON IMAGE PROCESSING 2021

# 29<sup>th</sup> Summer School on Image Processing

The annual gathering of researchers and professionals dealing with image analysis and machine vision

Rijeka, Croatia, 8-17 July 2021

<https://SSIP2021.riteh.hr> ✉ [ssip2021@riteh.hr](mailto:ssip2021@riteh.hr)

The 29th Summer School on Image Processing will be held at the University of Rijeka Faculty of Engineering in Rijeka, Croatia, between 8 and 17 July 2021. Fifty students, mostly doctoral and young researchers will attend the lectures given by numerous world-renowned researchers, and will work on exciting hands-on projects under their mentorship. The students will also be given the opportunity to present their work through a poster session. The summer school is co-organised by the University of Rijeka Faculty of Engineering (RITEH) and the Center for Artificial Intelligence and Cybersecurity (AIRI).

### Speakers

- Péter Balázs, University of Szeged, HU
- Hrvoje Bogunović, Medical University of Vienna, AT
- Marina Ivašić Kos, University of Rijeka, HR
- Radu Tudor Ionescu, University of Bucharest, RO
- André Kaup, Friedrich-Alexander University Erlangen-Nuremberg, DE
- Tibor Lukić, University of Novi Sad, RS
- Matija Milanič, University of Ljubljana, SI
- Antal Nagy, University of Szeged, HU
- Kálmán Palágyi, University of Szeged, HU
- Ernst Schwartz, Medical University Vienna, AT
- Erich Sorantin, Medical University of Graz, AT
- Darko Štern, Medical University of Graz, AT
- Ilkay Oksuz, Istanbul Technical University, TR
- László Varga, University of Szeged, HU
- Janez Perš, University of Ljubljana, SI
- Alexander Bornik, Ludwig Boltzmann Institute for Archaeological Prospection and Virtual Archaeology, AT
- Jiri Matas, Czech Technical University in Prague, CZ



### School directors

Ivan Štajduhar  
Sandi Ljubić  
Jonatan Lerga  
Marina Ivašić-Kos

### School organizers

Franko Hrižić  
Ana Vranković  
Alen Salkanović

Denis Selimović  
Arian Skoki  
Luka Batistić



Ljetna škola na temu analize slike SSIP 2021 organizirana je i provedena na Tehničkom fakultetu u Rijeci između 8. i 17. srpnja 2021. Unatoč izazovima prouzročeni pandemijom koronavirusa, ova, dvadeset deveta po redu ljetna škola SSIP bila je jedna od najposjećenijih dosad. Program škole bio je strukturiran tako da su po predavanjima svjetski uvaženi znanstvenici u jutarnjim satima, studenti u poslijepodnevnom satima radili na svojim praktičnim projektnim zadacima u međunarodnim timovima. Zadnji dan škole timovi su prezentirali svoje projekte, koje je ocijenilo povjerenstvo sastavljeno od gostujućih predavača. Isto tako, zadnji dan škole studenti su polagali ispit kojim se provjerilo jesu li stekli znanja i vještine koje odgovaraju zadanim ishodima učenja programa. Službeni jezik ljetne škole bio je engleski. Svi su sudionici škole, njih 50-ak, izrazili veliko zadovoljstvo našom organizacijom doga-

The Summer School on Image Processing (SSIP 2021) was organised and held at the Faculty of Engineering in Rijeka from 8-17 July 2021. Despite the challenges posed by the coronavirus pandemic, the 29th SSIP was one of the best attended so far. The school programme was structured in such a way that following lectures given by world-renowned scientists in the morning, students worked on their practical project assignments in international teams in the afternoon. On the last day of the school, the teams presented their projects, which were evaluated by a committee composed of guest lecturers. In addition, on the last day of the school, students took an exam to check whether they had acquired the knowledge and skills that matched the given learning outcomes of the programme. The official language of the summer school was English. All participants of the school, about 50 of

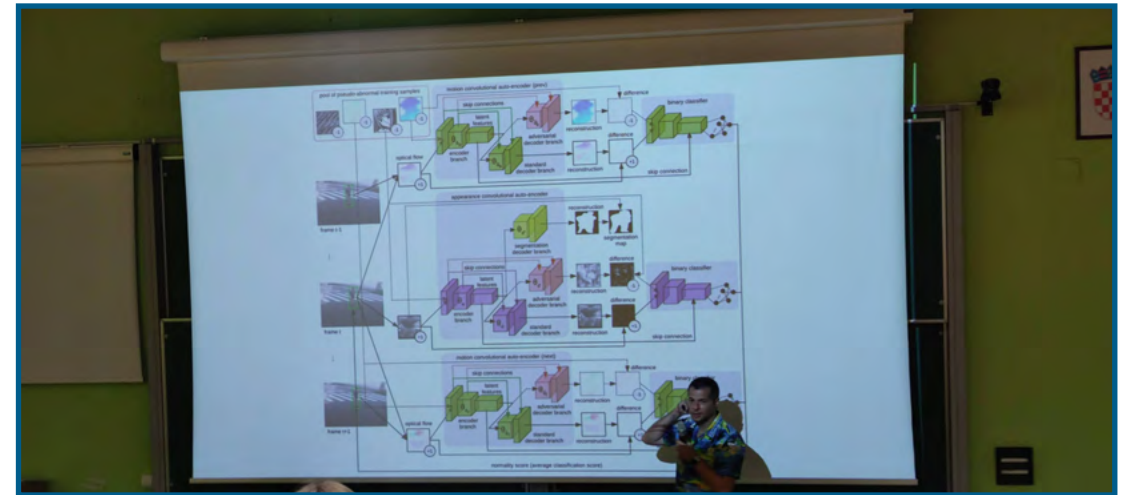

đaja te su obećali prenijeti pozitivne dojmove svojim matičnim institucijama.

Neke od širih tema koje su bile pokrivene ovom školom uključuju: (1) karakteristike odabranih suvremenih tehnika akvizicije slike (tomografija, magnetska rezonancija, optičko hiperspektralno i multispektralno snimanje i sl.); (2) karakteristike odabranih postupaka analize slike matematičkim modeliranjem, poput pripreme obrade slike, predstave oblika, morfologije oblika, opisa teksture, segmentacije oblika, prepoznavanja oblika, registracije slika i sl.; (3) karakteristike odabranih postupaka temeljenih na strojnom učenju za analizu slike, poput tradicionalnih (nasumična šuma, stroj potpornih vektora, grafički model i sl.) i postupaka dubokog učenja (konvolucijska neuronska mreža, pozorna mreža, generativni suparnički model i sl.) za zadaću klasifikacije i semantičke segmentacije oblika, restauracije, super rezolucije i sl.

them, expressed great satisfaction with our organisation of the event and promised to pass on their positive impressions to their home institutions.

Some of the broader topics covered by the school included: (1) characteristics of selected modern image acquisition techniques (tomography, magnetic resonance imaging, optical hyperspectral and multispectral imaging, etc.); (2) characteristics of selected image analysis procedures by mathematical modelling, such as preparatory image processing, shape representation, shape morphology, texture description, shape segmentation, shape recognition, image registration, etc.; (3) characteristics of selected machine learning-based procedures for image analysis, such as traditional (random forests, support vector machine, graphical model, etc.) and deep learning procedures (convolutional neural network, attention network, generative adversarial model,

Kao susret studenata i predavača koji se bave računalnom analizom slike, program SSIP uključivao je održavanje znanstvenih i stručnih predavanja, razmjenu iskustava među studentima i predavačima (metodološke rasprave i mentoriranje), rad na zanimljivim projektima iz stvarnog svijeta vezanim uz analizu slike, pod mentorstvom stručnjaka, rad u međunarodnim timovima, prijateljsko nadmetanje timova, prezentaciju i ocjenu rada na projektima, prezentaciju znanstvenog rada studenata (sekcija postera), završnu provjeru znanja i upoznavanje povijesnih, kulturnih, prirodnih i drugih znamenitosti grada domaćina i uže regije. Svi su aktivni polaznici ljetne škole dobili potvrdu o sudjelovanju, koja uključuje i postignutu ocjenu na ispitu. Najbolji studenti, oni koji su ostvarili najviši uspjeh na ispitu (90%, A) te studenti koji su bili članovi prva tri najviše rangirana studentska tima, dobili su dodatne nagrade. Nekoliko europskih sveučilišta priznaje sudjelovanje na SSIP-u kao izborne ECTS bodove na doktorskim studijima.

<https://ssip2021.riteh.hr/>

etc.) for the task of classification and semantic segmentation, restoration, super resolution, etc.

As a meeting of students and lecturers dealing with computer image analysis, the SSIP programme involved holding scientific and professional lectures, an exchange of experiences among students and lecturers (methodological discussions and tutoring), work on interesting real-world projects related to image analysis under the supervision of experts, work in international teams, friendly team competitions, presentation and evaluation of project work, presentation of students' scientific work (poster section), a final evaluation test and getting to know the historical, cultural, natural and other sights of the host city and region. All active participants of the summer school received a certificate of participation, which included the grade achieved in the exam. The best students, those who achieved the highest success in the exam (90%, A) and students who were members of the three highest ranked student teams, received additional awards. Several European universities recognise participation in the SSIP as elective ECTS credits in doctoral studies.

<https://ssip2021.riteh.hr/>

## 2.8.6 11. SUSRETI HRVATSKOG DRUŠTVA ZA MEHANIKU 11<sup>th</sup> MEETING OF THE CROATIAN SOCIETY OF MECHANICS



U organizaciji Hrvatskog društva za mehaniku (HDM) Podružnice u Rijeci, a pod pokroviteljstvom Sveučilišta u Rijeci i Tehničkog fakulteta, 16. i 17. rujna 2021. godine, na Tehničkom fakultetu Sveučilišta u Rijeci, održan je 11. susret HDM-a. Cilj Susreta je, u skladu sa Statutom HDM-a, okupljanje znanstvenika, stručnjaka, istraživača i nastavnika koji se bave svim područjima tehničke i teorijske mehanike i mehanike fluida radi populariziranja i širenja znanja i poticanja znanstvenoistraživačkog rada u području mehanike. Niz predavanja i izlaganja predstavila su interdisciplinarnu platformu za istraživače, praktičare i nastavnike s ciljem prezentacije najnovijih inovacija, teorija i praktičnih izazova s kojima se susreću, kao i rješenjima usvojenim u područjima klasične mehanike, mehanike čvrstih tijela i fluida, računalne mehanike i inženjerstva. Uz to, jedna od namjera skupa je promicanje unaprjeđenja sustava visokog obrazovanja u Republici Hrvatskoj kroz bolje povezivanje nastavnika i studenata diplomskih i poslijediplomskih studija putem izrade zajedničkih publikacija, čime se studenti pripremaju za znanstveni rad. Posebna pažnja posvećena je poticanju uspo-

Organised by the Rijeka Branch of the Croatian Society of Mechanics (CSM- HDM), and under the auspices of the University of Rijeka and the Faculty of Engineering, the 11th CSM meeting was held on 16-17 September 2021 at the Faculty of Engineering of the University of Rijeka. The aim of the Meeting was, in accordance with the Statute of the CSM, to bring together scientists, experts, researchers and teachers working in all fields of technical and theoretical mechanics, and fluid mechanics, to popularise and disseminate knowledge and encourage scientific research in mechanics. A series of lectures and presentations provided an interdisciplinary platform for researchers, practitioners and teachers, with the aim of presenting the latest innovations, theories and practical challenges they face and the solutions they have adopted in the fields of classical mechanics, solid and fluid mechanics, computational mechanics and engineering. In addition, one of the intentions of the conference is to promote the improvement of the higher education system in the Republic of Croatia through better networking of teachers and students at graduate and postgraduate



**HDM**   
**HRVATSKO DRUŠTVO ZA MEHANIKU**  
 ZAGREB - OSIJEK - RIJEKA - SL. BROD - SPLIT

# 11. susret Hrvatskog društva za mehaniku

Rijeka, 16. - 17. rujna 2021.

stavljajući suradnje znanstvenika i stručnjaka iz gospodarstva: doprinosimo društvu, naročito gospodarstvu, transferom znanja i tehnologija, razvijamo visoko obrazovanje, znanstvenoistraživački i stručni rad na visokim standardima izvrsnosti.

U dva dana trajanja Susreta, održano je 51 izlaganje, dok Zbornik radova 11. susreta HDMa broji ukupno 50 cjelovitih radova s ukupnim brojem 108 autora i koautora.

levels through the production of joint publications which prepare students for scientific work. Special attention is paid to encouraging the establishment of cooperation between scientists and experts from the economy. We contribute to society, especially the economy, and the transfer of knowledge and technology. We also develop higher education, scientific research and professional work to high standards of excellence.

In the two days of the Meeting, 51 presentations were held, while the Proceedings of the 11th CSM Meeting has a total of 50 complete papers, featuring a total of 108 authors and co-authors.



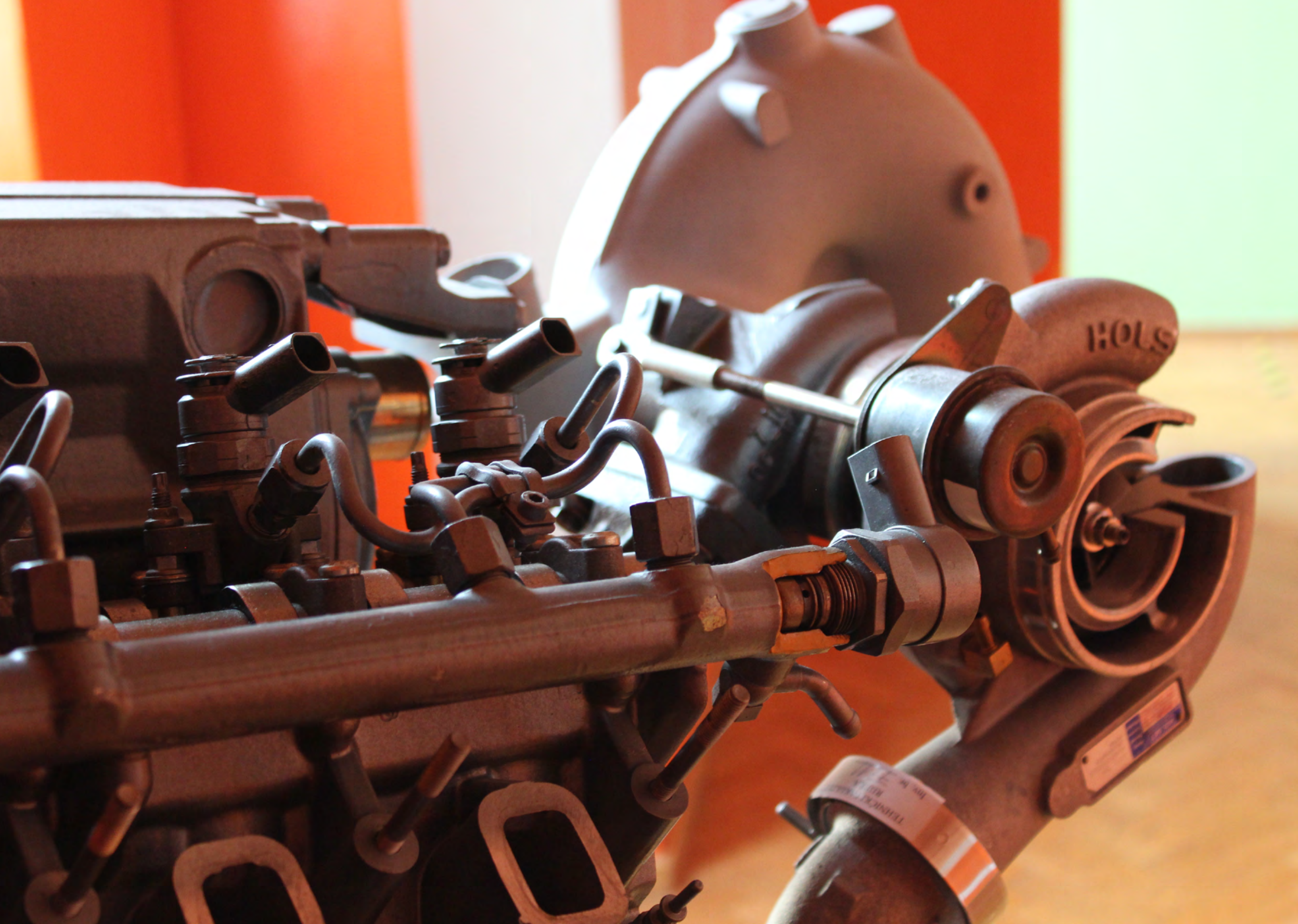

# 3 STUDIJSKI PROGRAMI NA FAKULTETU

## STUDY PROGRAMMES AT THE FACULTY



126

PREDDIPLOMSKI SVEUČILIŠNI STUDIJ 3-godišnji (180 ECTS)		UNDERGRADUATE UNIVERSITY STUDY 3 years (180 ECTS)	
Studij	Naziv	Study	Title
Strojarstvo	Sveučilišni prvostupnik inženjer strojarstva	Mechanical Engineering	University Bachelor Engineer of Mechanical Engineering
Brodogradnja	Sveučilišni prvostupnik inženjer brodogradnje	Naval Architecture	University Bachelor Engineer of Naval Architecture
Elektrotehnika	Sveučilišni prvostupnik inženjer elektrotehnike	Electrical Engineering	University Bachelor Engineer of Electrical Engineering
Računarstvo	Sveučilišni prvostupnik inženjer računarstva	Computing	University Bachelor Engineer of Computing

DIPLOMSKI SVEUČILIŠNI STUDIJ 2-godišnji (120 ECTS)		GRADUATE UNIVERSITY STUDY 2 years (120 ECTS)	
Studij	Naziv	Study	Title
Strojarstvo	Magistar inženjer strojarstva	Mechanical Engineering	Master of Mechanical Engineering
Brodogradnja	Magistar inženjer brodogradnje	Naval Architecture	Master of Naval Architecture
Elektrotehnika	Magistar inženjer elektrotehnike	Electrical Engineering	Master of Electrical Engineering
Računarstvo	Magistar inženjer računarstva	Computing	Master of Computing

POSLIJEDIPLOMSKI SVEUČILIŠNI (DOKTORSKI) STUDIJ 3-godišnji (180 ECTS)		POSTGRADUATE UNIVERSITY (DOCTORAL) STUDY 3 years (180 ECTS)	
Studij	Naziv	Study	Title
Strojarstvo, Brodogradnja, Temeljne tehničke znanosti i Interdisciplinarni tehničke znanosti	Doktor znanosti, područje Tehničkih znanosti	Mechanical Engineering, Naval Architecture, Fundamental Engineering Sciences and Interdisciplinary Engineering	D. Sc. in the area of Engineering Sciences
Elektrotehnika		Electrical Engineering	
Računarstvo		Computer Science	

PREDDIPLOMSKI STRUČNI STUDIJ 3-godišnji (180 ECTS)		UNDERGRADUATE VOCATIONAL STUDY 3 years (180 ECTS)	
Studij	Naziv	Study	Title
Strojarstvo	Stručni prvostupnik inženjer strojarstva	Mechanical Engineering	Bachelor Engineer of Mechanical Engineering
Brodogradnja	Stručni prvostupnik inženjer brodogradnje	Naval Architecture	Bachelor Engineer of Naval Architecture
Elektrotehnika	Stručni prvostupnik inženjer elektrotehnike	Electrical Engineering	Bachelor Engineer of Electrical Engineering

Studiji na Tehničkom fakultetu ustrojenu su prema Bolonjskom modelu 3 + 2 + 3, što znači da se obrazovanje provodi kroz preddiplomski sveučilišni studij u trajanju od tri godine kojim se stječe 180 ECTS bodova, zatim diplomski sveučilišni studij u trajanju od dvije godine kojim se stječe 120 ECTS bodova te poslijediplomski sveučilišni (doktorski) studij u trajanju od tri godine kojim se stječe 180 ECTS bodova.

Osim tih studija, obrazovanje se provodi i kroz preddiplomske stručne studije u trajanju od tri godine kojima se stječe također 180 ECTS bodova. Taj je sustav s vrstama pojedinih studija i stečenim nazivima prikazan u tablici. U nastavku su opisane osnovne značajke pojedinog studija.

### PREDDIPLOMSKI SVEUČILIŠNI STUDIJ STROJARSTVA

Preddiplomski sveučilišni studij strojarstva pripremat će studente za diplomski sveučilišni studij strojarstva, ali će im pružati i mogućnost zapošljavanja na odgovarajućim stručnim poslovima. Studij ima za cilj osposobljavanje studenata za primjenu temeljnih i specijalističkih znanja iz strojarstva, prepoznavanje, oblikovanje i rješavanje problema iz prakse, primjenu drugih stečenih znanja iz tehnike, matematike i računarstva, korištenje suvremenih inženjerskih alata, razumijevanje timskog rada i učinkovite komunikacije, razumijevanje etičnosti i etičke odgovornosti, te razumijevanje utjecaja inženjerskih rješenja na društvo i okolinu. Završeni student ovog studija mora biti sposoban uključiti se u kontinuirano obrazovanje i profesionalni razvoj, te posjedovati šire obrazovanje (poznavanje tema izvan tehnike).

Odluči li se student za nastavak studija, on će moći upisati diplomski sveučilišni studij strojarstva na Tehničkom fakultetu Sveučilišta u Rijeci, odnosno isti takav studij na ostalim sveučilištima u Republici Hrvatskoj.

Studies at the Faculty of Engineering are set according to the Bologna model 3 + 2 + 3, which means that education continues through a three year long undergraduate university study resulting in 180 ECTS credits obtained, followed by a two year graduate university study resulting in 120 ECTS credits obtained and a postgraduate university (doctoral) study which lasts three years and results in 180 ECTS credits obtained.

Apart from these studies, education is accomplished through a three year undergraduate vocational study that results in 180 ECTS credits. The curricula with the respective types of studies and obtained titles are shown in the following table. The basic characteristics of each study are described below.

### UNDERGRADUATE UNIVERSITY STUDY OF MECHANICAL ENGINEERING

Undergraduate university study in Mechanical Engineering shall prepare students for the graduate university study in Mechanical Engineering, and shall also provide opportunities for employment at appropriate professional positions. The aim of the study is to train students to apply basic and specialist knowledge in mechanical engineering, to recognise, form, and solve practical problems, to apply other acquired knowledge in engineering, mathematics, and computer engineering, to use modern engineering tools, to understand teamwork and effective communication, to understand ethics and ethical responsibility, and to understand the influence of engineering solutions on the society and the surroundings. Graduating students must be capable of pursuing lifelong learning and professional development, and they must have a broad education (being familiar with topics outside engineering). If students decide to continue their study, they shall be able to enrol into the graduate university study in Mechanical Engineering at the University of Rijeka, Faculty of Engineering, or same study at other universities in Croatia.



127



Prediplomski sveučilišni studij		S		Brodogradnja		S		Elektrotehnika		S		Računarstvo	
S Strojarstvo		N	B	Predmet		N	B	Predmet		N	B	Predmet	
I	Matematika I	6	7	I	Matematika I	6	7	I	Matematika I	6	7	I	Matematika I
	Statika	5	6		Statika	5	6		Fizika I	4	5		Uvod u modernu fiziku
	Materijali I	4	4		Materijali I	4	4		Osnove elektrotehnike I	6	7		Elektrotehnika R
	Elektrotehnika	3	5		Elektrotehnika	3	5		Programska podrška u inženjerstvu	4	6		Programiranje I
	Primjena računala u inženjerstvu	3	4		Primjena računala u inženjerstvu	3	4		Inženjerska grafika i dokumentiranje	4	5		Računalne vještine
	Inženjerska grafika	4	4		Inženjerska grafika	4	4		Engleski jezik I	6	7		Engleski jezik I
II	Matematika II	6	7	II	Matematika II	6	7	II	Matematika II	6	7	II	Matematika II
	Kinematika	5	6		Kinematika	5	6		Fizika II	4	5		Elektrotehnika
	Čvrstoća konstrukcija I	6	7		Čvrstoća konstrukcija	6	7		Osnove elektrotehnike II	6	7		Programiranje II
	Materijali II	3	5		Materijali II	3	5		Programiranje	4	6		Digitarna logika
	Dinamika	4	5	III	Dinamika	4	5	III	Tehnologija materijala	3	5		Engleski jezik II
	Oblikovanje pomoću računala	4	5		Oblikovanje pomoću računala	4	5		Inženjerska matematika R	5	7		Inženjerska matematika R
III	Mehanika fluida	5	5	III	Mehanika fluida	5	5	III	Mjerenja u elektrotehnici	5	7		Algoritmi i strukture podataka
	Termodinamika I	6	7		Završavanje I	3	4		Elektrotehnika I	4	6		Grafica računala
	Mjerenja i kontrola kvalitete	3	5		Termodinamika BG	4	5		Elektrone mreže	4	7		Signalni sustavi
	Računarske metode	4	5		Uvod u plovidne objekte	3	4		Strani jezik I	2	3		Uvod u objektno orj. programiranje
	Strani jezik I	2	3		Osnove konstrukcijskih elemenata	4	4		Engleski jezik I	2	3		
					Engleski jezik I	2	3						
IV	Inženjerska statistika	4	5	IV	Inženjerska statistika	4	5	IV	Digitalna elektronika	4	6	IV	Operacijski sustavi
	Konstrukcijski elementi I	5	7		Brodске forme	5	6		Elektronika II	4	6		Računalne mreže
	Hydraulički strojevi	4	5		Osnove gradnje broda	3	5		Osnove regulacijske tehnike	4	6		Računalna grafika
	Proizvodne tehnologije	4	5		Konstrukcija broda I	4	6		Izborni kolegij I	4	4		Izborni kolegij I
	Strani jezik II	2	3		Strani jezik II	2	3		Strani jezik II	2	3		Stručna praksa I
	Stručna praksa I	5	5		Stručna praksa I	5	5		Stručna praksa I	5	5		
V	Konstrukcijski elementi II	6	7	V	Plovidni i stabilitet broda	6	7	V	Električni strojevi	5	6	V	Ugradbeni računalni sustavi
	Toplinski strojevi i uređaji	4	5		Oprema broda	4	6		Energetska elektronika	5	6		Baze podataka
	Proizvodni strojevi, alati i naprave	4	5		Konstrukcija broda II	4	6		Signalni sustavi	4	6		Razvoj web aplikacija
	Kolegij izborne skupine	4	4		Tehnologija brodogradnje	4	6		Kolegij izborne skupine	4	7		Izborni kolegij II
	Tehnološki procesi	4	4		Izborni projekt	3	5		Izborni projekt	3	5		Izborni projekt
	Izborni projekt	3	5										
VI	Energetski sustavi	4	4	VI	Organizacija i ekonomika posl. sust.	3	4	VI	Elektromotorni pogoni	4	5	VI	Programsko inženjerstvo
	Automatizacija	3	4		Hydrodinamika plovnih objekata I	6	8		Organizacija i ekonomika posl. sust.	3	4		Organizacija i ekonomika posl. sust.
	Kolegij izborne skupine	4	4		Slobodni kolegij I	3	4		Kolegij izborne skupine	5	7		Uvod u umjetnu inteligenciju
	Organizacija i ekonomika posl. sust.	3	4		Slobodni kolegij II	3	4		Slobodni kolegij	3	4		Slobodni kolegij
	Slobodni kolegij	3	4		Završni rad	10	10		Završni rad	10	10		Završni rad
	Završni rad	10	10										

(Studijski programi pojedinih studija prikazani su na gornjoj i na tablicama koje slijede: sa S je označen semestar u kojem se predmet predaje, s N su označeni sati nastave tjedno, a s B broj ECTS bodova pripadnog predmeta.)

Undergraduate University Studies		S		Naval Architecture		S		Electrical Engineering		S		Computing	
S Mechanical Engineering		N	B	Course		N	B	Course		N	B	Course	
I	Mathematics I	6	7	I	Mathematics I	6	7	I	Mathematics I	6	7	I	Mathematics I
	Statics	5	6		Statics	5	6		Physics I	4	5		Introduction to Modern Physics
	Materials I	4	4		Materials I	4	4		Fundamentals of Electrical Engineering I	6	7		Electrical Engineering CE
	Electrical Engineering	3	5		Electrical Engineering	3	5		Computer Software in Engineering	4	6		Programming I
	Computer Applications in Engineering	3	4		Computer Applications in Engineering	3	4		Engineering Graphics and Documenting	4	5		Computer Skills
	Engineering Graphics	4	4		Engineering Graphics	4	4		Mathematics II	6	7	II	Mathematics II
	Kinematics	5	6		Kinematics	5	6		Physics II	4	5		Electronics
	Strength of Materials I	6	7		Strength of Materials	6	7		Fundamentals of Electrical Engineering II	6	7		Programming II
	Materials II	3	5		Materials II	3	5		Programming	3	5		Digital Logic
	Modelling by Computer	4	5		Modelling by Computer	4	5		Materials Technology	3	5		English Language II
	Dynamics	4	5	III	Dynamics	4	5	III	Mathematics for Engineers EE	5	7	III	Mathematics for Engineers CE
	Fluid Mechanics	5	5		Fluid Mechanics	5	5		Measurements in the Electrical Engineering	5	7		Algorithms and Data Structures
	Thermodynamics I	3	5		Welding Engineering I	3	4		Electronics I	4	6		Computer Architecture
	Measurements and Quality Control	3	5		Thermodynamics NA	4	5		Electrical Circuits	4	7		Signals and Systems
	Computational Methods	4	5		Introduction to Marine Vessels	3	4		Foreign Language I	2	3		Introduction to Object Oriented Programming
	Foreign Language I	2	3		Basics of Machine Elements Design	4	4						
					English Language I	2	3						
IV	Engineering Statistics	4	5	IV	Engineering Statistics	4	5	IV	Digital Electronics	4	6	IV	Operating Systems
	Machine Elements Design I	4	5		Machine Elements Design I	4	5		Electronics II	4	6		Computer Networks
	Hydraulic Machines	4	5		Ship Hull Forms	3	5		Fundamentals of Automatic Control	4	6		Computer Graphics
	Production Technologies	4	5		Basics of Ship Production	4	6		Elective Subject	4	4		Elective Subject I
	Foreign Language II	2	3		Ship Structure I	2	3		Foreign Language II	2	3		Professional practice I
	Professional practice I	5	5		Professional Practice I	5	5		Professional Practice I	5	5		
	Machine Elements Design II	6	7	V	Seaworthiness and Stability of the Ship	6	7	V	Electrical Machines	5	6	V	Embedded Systems
	Heat Engines and Devices	4	5		Ship Equipment	4	6		Power Electronics	5	6		Database Systems
	Production Machines, Tools, Jigs and Fixtures	4	5		Ship Structure II	4	6		Signals and Systems	4	6		Web Application Development
	Elective group course	4	4		Shipbuilding Technology	4	6		Elective group course	4	7		Elective Subject II
	Technological Processes	4	4		Elective project	3	5		Elective project	3	5		Elective project
	Elective project	3	5										
VI	Energy Systems	4	4	VI	Organization and Economics of Business System	3	4	VI	Electrical Drives	4	5	VI	Software Engineering
	Automation	3	4		Marine Hydrodynamics I	6	8		Organization and Economics of Business System	3	4		Organization and Economics of Business System
	Elective group course	4	4		Free Elective Subject I	3	4		Elective group course	5	7		Introduction to Artificial Intelligence
	Organization and Economics of Business System	3	4		Free Elective Subject II	3	4		Free Elective Subject	3	4		Free Elective Subject
	Free Elective Subject	3	4		Final Work	10	10		Final work	10	10		Final work
	Final work	10	10										

(Curricula of the described studies are presented above and in the tables below: S signifies the semester in which the course is placed, with N lecturing hours per week, and B the number representing ECTS credits.)

**PREDDIPLOMSKI SVEUČILIŠNI STUDIJ BRODOGRADNJE**

Preddiplomski sveučilišni studij brodogradnje pripremat će studente za diplomski sveučilišni studij brodogradnje, ali će im pružati i mogućnost zapošljavanja na odgovarajućim stručnim poslovima. Na preddiplomskom studiju brodogradnje polaznicima će se u razumnoj količini i na dovoljno visokoj razini davati znanje iz temeljnih tehničkih sadržaja s jedne strane, te iz glavnih brodograđevnih sadržaja s druge strane, kako bi u svojoj radnoj praksi, kao i u svom daljnjem stručnom i znanstvenom usavršavanju, uvijek bili na razini postavljenih zadataka. Svojim opsegom i sadržajem ovaj će studij polazniku davati potrebnu širinu stručnih znanja koja ga po završetku studija osposobljava za samostalan rad, odnosno za rad u stručnim timovima u bilo kojem segmentu brodograđevne struke. Završeni student ovog studija mora biti sposoban uključiti se u kontinuirano obrazovanje i profesionalni razvoj, te posjedovati šire obrazovanje (poznavanje tema izvan tehnike).

Odluči li se student za nastavak studija, on će moći upisati diplomski sveučilišni studij brodogradnje na Tehničkom fakultetu Sveučilišta u Rijeci, odnosno isti takav studij na ostalim sveučilištima u Republici Hrvatskoj.

**PREDDIPLOMSKI SVEUČILIŠNI STUDIJ ELEKTROTEHNIKE**

Preddiplomski sveučilišni studij elektrotehnike pripremat će studente za diplomski sveučilišni studij elektrotehnike, ali će im pružati i mogućnost zapošljavanja na odgovarajućim stručnim poslovima. Studij ima za cilj osposobljavanje studenata za primjenu temeljnih i specijalističkih znanja iz elektrotehnike, prepoznavanje, oblikovanje i rješavanje problema iz prakse, primjenu drugih stečenih znanja iz tehnike, matematike i računarstva, korištenje suvremenih inženjerskih alata, razumijevanje timskog rada i učinkovite komunikacije, razumijevanje etičnosti i etičke odgovornosti, te razumijevanje utjecaja inženjerskih rješenja na društvo i okolinu. Završeni student ovog studija mora biti sposoban uključiti se u kontinuirano obrazovanje i profesionalni razvoj, te posjedovati šire obrazovanje (poznavanje tema izvan tehnike).

Odluči li se student za nastavak studija, on će moći upisati diplomski sveučilišni studij elektrotehnike na Tehničkom fakultetu Sveučilišta u Rijeci, odnosno isti takav studij na ostalim sveučilištima u Republici Hrvatskoj.

**UNDERGRADUATE UNIVERSITY STUDY OF NAVAL ARCHITECTURE**

Undergraduate university study in Naval Architecture shall prepare students for the graduate university study in Naval Architecture, and shall also provide opportunities for employment at appropriate professional positions. In the undergraduate study in Naval Architecture, the students shall be provided in a reasonable amount and at a sufficiently high level with knowledge in basic engineering on the one hand, and on the other, in main subjects of naval architecture, so that in their student practice, as well as in their further professional development, they shall meet the demands of the given tasks. In its scope and content, the study shall provide students with the necessary breadth of professional knowledge that shall enable them at the end of their study to carry out work independently and in professional teams in any segment of naval architecture. Graduating students must be capable of pursuing lifelong learning and professional development, and they must have a broad education (being familiar with topics outside engineering). If students decide to continue their study, they shall be able to enrol into the graduate university study in Naval Architecture at the University of Rijeka, Faculty of Engineering, or same study at other universities in Croatia.

**UNDERGRADUATE UNIVERSITY STUDY OF ELECTRICAL ENGINEERING**

Undergraduate university study in Electrical Engineering shall prepare students for the graduate university study in Electrical Engineering, and shall also provide opportunities for employment at appropriate professional positions. The aim of the study is to train students to apply basic and specialist knowledge in electrical engineering, to recognise, form, and solve practical problems, to apply other acquired knowledge in engineering, mathematics, and computer engineering, to use modern engineering tools, to understand teamwork and effective communication, to understand ethics and ethical responsibility, and to understand the influence of engineering solutions on the society and the surroundings. Graduating students must be capable of pursuing lifelong learning and professional development, and they must have a broad education (being familiar with topics outside engineering). If students decide to continue their study, they shall be able to enrol into the graduate university study in Electrical Engineering at the University of Rijeka, Faculty of Engineering, or same study at other universities in Croatia.

**PREDDIPLOMSKI SVEUČILIŠNI STUDIJ RAČUNARSTVA**

Preddiplomski sveučilišni studij računarstva pripremat će studente za diplomski sveučilišni studij računarstva, ali će im pružati i mogućnost zapošljavanja na odgovarajućim stručnim poslovima. Studij ima za cilj osposobljavanje studenata za primjenu temeljnih i specijalističkih znanja iz računarstva za karakterizaciju, projektiranje, izvedbu, eksploatiranje i održavanje informacijskih i računalnih sustava i procesa, oblikovanje i rješavanje problema iz prakse, primjenu informacijske i komunikacijske tehnologije u privrednim i društvenim subjektima, korištenje suvremenih inženjerskih alata, razumijevanje timskog rada i učinkovite komunikacije, razumijevanje etičnosti i etičke odgovornosti, vrednovanje informacijsko-komunikacijske tehnologije na osnovi kritičkog razmišljanja i intelektualnog poštenja te razumijevanje utjecaja inženjerskih rješenja na društvo i okolinu. Završeni student ovog studija mora biti sposoban uključiti se u kontinuirano obrazovanje i profesionalni razvoj, te posjedovati šire obrazovanje (poznavanje tema izvan tehnike).

Odluči li se student za nastavak studija, on će moći upisati diplomski sveučilišni studij računarstva na Tehničkom fakultetu Sveučilišta u Rijeci, odnosno isti takav studij na ostalim sveučilištima u Republici Hrvatskoj.

**DIPLOMSKI SVEUČILIŠNI STUDIJ STROJARSTVA**

Diplomskim sveučilišnim studijem strojarstva studenti stječu potrebna usko-specijalistička znanja iz navedenih područja te su time osposobljeni za obavljanje najsloženijih inženjerskih zadaća temeljenih na znanstvenom pristupu rješavanju problema. Stječu se nova specijalistička znanja iz strojarstva i sposobnost njegove primjene, kao i poznavanje i primjenu drugih specijalističkih znanja iz tehnike, matematike i računarstva. Studenti usvajaju sposobnost kontinuiranog obrazovanja i samoobrazovanja, sposobnosti samostalnog istraživanja, otkrivanja novih znanja, pripreme i izvođenja eksperimenata, te tumačenja podataka. Studijem se stječu znanja i kompetencije potrebne za projektiranje novih sustava, komponenata ili procesa, te učinkovito djelovanje u ulozi vođe tima. Studijski program sličan je programima studija na inozemnim visokim učilištima uz postizanje specifičnih zahtjeva sredine za koju se prvenstveno školuju kadrovi na Tehničkom fakultetu Sveučilišta u Rijeci. U studijski program ukomponirane su preporuke iz Bolonjske deklaracije koje se odnose na način osiguranja kvalitete studijskog

**UNDERGRADUATE UNIVERSITY STUDY OF COMPUTING**

Undergraduate university study in Computing shall prepare students for the graduate university study in Computing, and shall also provide opportunities for employment at appropriate professional positions. The aim of the study is to train students to apply basic and specialist knowledge in computer engineering to characterise, design, execute, exploit, and maintain information and computer systems and processes, to form and solve practical problems, to apply information and communication technology in economic and social entities, to use modern engineering tools to understand teamwork and effective communication, to understand ethics and ethical responsibility, to evaluate information and communication technology on the basis of critical thinking and intellectual integrity, and to understand the influence of engineering solutions on the society and the surroundings. Graduating students must be capable of pursuing lifelong learning and professional development, and they must have a broad education (being familiar with topics outside engineering). If students decide to continue their study, they shall be able to enrol into the graduate university study in Computing at the University of Rijeka, Faculty of Engineering, or same study at other universities in Croatia.

**GRADUATE UNIVERSITY STUDY OF MECHANICAL ENGINEERING**

Graduate university study in Mechanical Engineering enables students to acquire highly specialist knowledge in the field and to be trained to perform the most complex engineering tasks based on the scientific approach to problem-solving. New specialist knowledge is acquired in mechanical engineering, and students are able to apply that knowledge; the same is true for other specialist knowledge in engineering, mathematics, and computer engineering. Students gain the ability to engage in continuing education and professional development, the ability to carry out independent research, to discover new knowledge, to prepare and conduct experiments, and to interpret data. The study enables the acquisition of knowledge and competencies needed for designing new systems, components, or processes, and to act effectively in the role of a team leader. The study programme is similar to those at higher education institutions abroad, but meeting the specific demands of the community and region in which the University of Rijeka, Faculty of Engineering operates. The study programme incorporates recommendations from the



programa, mobilnost pri studiranju i priznavanju diploma.

Na ovom studiju omogućena je specijalizacija u jednom od sljedećih područja:

- » Konstruiranje i mehatronika
- » Računarska mehanika i inženjerstvo
- » Tehnološko-informatičko inženjerstvo
- » Industrijsko inženjerstvo i management
- » Termotehnika
- » Procesno i energetsko strojarstvo
- » Brodostrojarstvo
- » Inženjerstvo materijala

#### DIPLOMSKI SVEUČILIŠNI STUDIJ BRODOGRADNJE

Na diplomskom sveučilišnom studiju brodogradnje osposobljavat će se budući stručnjaci koji će raditi na poslovima i zadacima projektiranja i konstruiranja različitih vrsta i tipova plovni objekata, razvoja i vođenja tehnoloških procesa, poglavito gradnje i održavanja plovni objekata i objekata morske tehnologije, zatim na poslovima klasifikacijskih i nadzornih institucija, te drugim poslovima u širem području brodogradnje i inženjerstva morske tehnologije, odnosno pomorstva.

Ovaj studijski program nudi specijalizaciju u sljedećim područjima:

- » Projektiranje i konstrukcija plovni objekata
- » Tehnologija i organizacija brodogradnje

Studijski program slijedi preporuke iz Bolonjske deklaracije koje se odnose na način osiguranja kvalitete studijskog programa, mobilnosti pri studiranju te postupke priznavanja diploma.

#### DIPLOMSKI SVEUČILIŠNI STUDIJ ELEKTROTEHNIKE

Diplomskim sveučilišnim studijem elektrotehnike studenti stječu potrebna usko-specijalistička znanja iz navedenih područja te su time osposobljeni za obavljanje najsloženijih inženjerskih zadataka temeljenih na znanstvenom pristupu rješavanju problema. Stječu se nova specijalistička znanja iz elektrotehnike i sposobnost njegove primjene, kao i poznavanje i primjenu drugih specijalističkih znanja iz tehnike, matematike i računarstva. Studenti usvajaju sposobnost kontinuiranog obrazovanja i samoobrazovanja, sposobnosti samostalnog istraživanja, otkrivanja novih znanja, pripreme i izvođenja eksperimenata, te tumačenja podataka. Studijem se stječu znanja i kompetencije potrebne za projektiranje novih sustava, komponenata ili procesa, te učinkovito djelovanje u ulozi vođe tima. Studijski program sličan je programima studija na inozemnim visokim učilištima uz postizanje specifičnih zahtjeva sredine za koju se prvenstveno školuju kadrovi

Bologna Declaration that refer to programme quality assurance, mobility, and diploma recognition.

This study programme enables specialisation in one of the following areas:

- » Mechanical Engineering Design and Mechatronics
- » Computational Mechanics and Engineering
- » Technology Computational Engineering
- » Industrial Engineering and Management
- » Thermal Engineering
- » Process and Energy Engineering
- » Marine Engineering
- » Materials Engineering

#### GRADUATE UNIVERSITY STUDY OF NAVAL ARCHITECTURE

Graduate university study in Naval Architecture trains future experts who will work on jobs and tasks of designing and building different kinds and types of ships, developing and supervising technological processes, especially concerning construction and maintenance of ships and marine technology objects, jobs related to classification and inspection institutions, and other jobs in the broader field of naval architecture and marine technology engineering, that is, maritime affairs.

This study programme enables specialisation in the following areas:

- » Design and Construction of Ships
- » Technology and Organization of Shipbuilding

The study programme follows recommendations from the Bologna Declaration that refer to programme quality assurance, mobility, and diploma recognition.

#### GRADUATE UNIVERSITY STUDY OF ELECTRICAL ENGINEERING

Graduate university study in Electrical Engineering enables students to acquire highly specialist knowledge in the field and to be trained to perform the most complex engineering tasks based on the scientific approach to problem-solving. New specialist knowledge is acquired in electrical engineering, and students are able to apply that knowledge; the same is true for other specialist knowledge in engineering, mathematics, and computer engineering. Students gain the ability to engage in continuing education and professional development, the ability to carry out independent research, to discover new knowledge, to prepare and conduct experiments, and to interpret data. The study enables the acquisition of knowledge and competencies needed for designing new

na Tehničkom fakultetu Sveučilišta u Rijeci. U studijski program ukomponirane su preporuke iz Bolonjske deklaracije koje se odnose na način osiguranja kvalitete studijskog programa, mobilnost pri studiranju i priznavanju diploma.

Na ovom studiju omogućena je specijalizacija u jednom od sljedećih područja:

- » Automatika
- » Elektroenergetika

#### DIPLOMSKI SVEUČILIŠNI STUDIJ RAČUNARSTVA

Diplomskim sveučilišnim studijem računarstva studenti stječu potrebna usko-specijalistička znanja iz navedenih područja te su time osposobljeni za obavljanje najsloženijih inženjerskih zadataka temeljenih na znanstvenom pristupu rješavanju problema. Studenti usvajaju sposobnost interdisciplinarnog pristupa integraciji sustava, obrade informacija i traženja inovativnih rješenja. Samostalno će projektirati, upravljati, analizirati problem i predlagati rješenja vezana uz razvoj sklopovske i programske podrške i umrežavanja sustava. Znat će učinkovito birati i primjenjivati odgovarajuće suvremene alate i metode iz struke na kompleksne inženjerske aktivnosti. Steći će znanja i vještine za projektiranje sustava, komponenata i procesa koji odgovaraju specifičnim potrebama određenih područja.

Studijski program sličan je programima studija na inozemnim visokim učilištima uz postizanje specifičnih zahtjeva sredine za koju se prvenstveno školuju kadrovi na Tehničkom fakultetu Sveučilišta u Rijeci. U studijski program ukomponirane su preporuke iz Bolonjske deklaracije koje se odnose na način osiguranja kvalitete studijskog programa, mobilnost pri studiranju i priznavanju diploma.

Na ovom studiju omogućena je specijalizacija u jednom od sljedeća dva područja:

- » Programsko inženjerstvo
- » Računalni sustavi

systems, components, or processes, and to act effectively in the role of a team leader. The study programme is similar to those at higher education institutions abroad, but meeting the specific demands of the community and region in which the University of Rijeka Faculty of Engineering operates. The study programme incorporates recommendations from the Bologna Declaration that refer to programme quality assurance, mobility, and diploma recognition.

This study programme enables specialisation in one of the following areas:

- » Automation
- » Power Engineering

#### GRADUATE UNIVERSITY STUDY OF COMPUTING

Graduate university study in Computing enables students to acquire highly specialist knowledge in the field and to be trained to perform the most complex engineering tasks based on the scientific approach to problem-solving. Students develop the ability of an interdisciplinary approach to system integration, information processing, and to the search for innovative solution. Student independently design, manage, and analyse problems and offer solutions related to the development of circuit and software support and system networks. They efficiently choose and apply modern tools and methods from the profession to complex engineering activities. They acquire knowledge and skills needed for designing systems, components, and processes that meet specific demands of a given field. The study programme is similar to those at higher education institutions abroad, but meeting the specific demands of the community and region in which the University of Rijeka, Faculty of Engineering operates. The study programme incorporates recommendations from the Bologna Declaration that refer to programme quality assurance, mobility, and diploma recognition.

This study programme enables specialisation in one of the following two areas:

- » Software Engineering
- » Computer Systems



Diplomski sveučilišni studij			S Brodogradnja			S Elektrotehnika			S Računarstvo																																																																																																																																			
S	N	B	N	B	N	N	B	N	B	N	B																																																																																																																																	
I Inženjerska matematika	5	7	I	Inženjerska matematika	5	6	I	Numerička i stohastička matematika	4	6	I	Stohastička matematika	4	6																																																																																																																														
															II	5	7	II	Cvrstota broda	4	5	Upravljanje elektromotornim pogonima	4	6	II	Teorija informacija i kodiranje	4	6																																																																																																																
																													III	5	7	III	Brodska elektrotehnika	3	4	Kolegij izborne skupine	4	6	III	Izborni kolegij Z	8	12																																																																																																		
																																											IV	5	7	IV	Metodologija gradnje plovnih objekata	4	5	Kolegij izborne skupine	4	6	IV	Kolegij izborne skupine	4	6																																																																																				
																																																									V	5	7	V	Računarske metode u brodogradnji	4	4	Kolegij izborne skupine	4	6	V	Kolegij izborne skupine	4	6																																																																						
																																																																							VI	5	7	VI	Kolegij izborne skupine	5	6	Kolegij izborne skupine	4	6	VI	Kolegij izborne skupine	4	6																																																								
																																																																																					VII	5	7	VII	Kolegij izborne skupine	4	5	Kolegij izborne skupine	2	5	VII	Inženjersko kompleksnih programskih sustava	6	7																																										
																																																																																																			VIII	5	7	VIII	Kolegij izborne skupine	4	5	Kolegij izborne skupine	2	5	VIII	Projekt I	6	7																												
																																																																																																																	IX	5	7	IX	Kolegij izborne skupine	4	5	Kolegij izborne skupine	4	5	IX	Projekt II	5	7														
																																																																																																																															X	5	7	X	Kolegij izborne skupine	4	5	Kolegij izborne skupine	4	5	X	Stručna praksa II	5	7
XII	5	7	XII	Kolegij izborne skupine	4	5	Kolegij izborne skupine	4	5	XII	Kolegij izborne skupine	4	7																																																																																																																															
														XIII	5	7	XIII	Kolegij izborne skupine	4	5	Kolegij izborne skupine	4	5	XIII	Kolegij izborne skupine	4	7																																																																																																																	
																												XIV	5	7	XIV	Kolegij izborne skupine	4	5	Kolegij izborne skupine	4	5	XIV	Kolegij izborne skupine	4	7																																																																																																			
																																										XV	5	7	XV	Kolegij izborne skupine	4	5	Kolegij izborne skupine	4	5	XV	Kolegij izborne skupine	4	7																																																																																					
																																																								XVI	5	7	XVI	Kolegij izborne skupine	4	5	Kolegij izborne skupine	4	5	XVI	Kolegij izborne skupine	4	7																																																																							
																																																																						XVII	5	7	XVII	Kolegij izborne skupine	4	5	Kolegij izborne skupine	4	5	XVII	Kolegij izborne skupine	4	7																																																									
																																																																																				XVIII	5	7	XVIII	Kolegij izborne skupine	4	5	Kolegij izborne skupine	4	5	XVIII	Kolegij izborne skupine	4	7																																											
																																																																																																		XIX	5	7	XIX	Kolegij izborne skupine	4	5	Kolegij izborne skupine	4	5	XIX	Kolegij izborne skupine	4	7																													
																																																																																																																XX	5	7	XX	Kolegij izborne skupine	4	5	Kolegij izborne skupine	4	5	XX	Kolegij izborne skupine	4	7															
																																																																																																																														XXI	5	7	XXI	Kolegij izborne skupine	4	5	Kolegij izborne skupine	4	5	XXI	Kolegij izborne skupine	4	7	
																																																																																																																																												XXII
XXIII	5	7	XXIII	Kolegij izborne skupine	4	5	Kolegij izborne skupine	4	5	XXIII	Kolegij izborne skupine	4	7																																																																																																																															
														XXIV	5	7	XXIV	Kolegij izborne skupine	4	5	Kolegij izborne skupine	4	5	XXIV	Kolegij izborne skupine	4	7																																																																																																																	
																												XXV	5	7	XXV	Kolegij izborne skupine	4	5	Kolegij izborne skupine	4	5	XXV	Kolegij izborne skupine	4	7																																																																																																			
																																										XXVI	5	7	XXVI	Kolegij izborne skupine	4	5	Kolegij izborne skupine	4	5	XXVI	Kolegij izborne skupine	4	7																																																																																					
																																																								XXVII	5	7	XXVII	Kolegij izborne skupine	4	5	Kolegij izborne skupine	4	5	XXVII	Kolegij izborne skupine	4	7																																																																							
																																																																						XXVIII	5	7	XXVIII	Kolegij izborne skupine	4	5	Kolegij izborne skupine	4	5	XXVIII	Kolegij izborne skupine	4	7																																																									
																																																																																				XXIX	5	7	XXIX	Kolegij izborne skupine	4	5	Kolegij izborne skupine	4	5	XXIX	Kolegij izborne skupine	4	7																																											
																																																																																																		XXX	5	7	XXX	Kolegij izborne skupine	4	5	Kolegij izborne skupine	4	5	XXX	Kolegij izborne skupine	4	7																													
																																																																																																																XXXI	5	7	XXXI	Kolegij izborne skupine	4	5	Kolegij izborne skupine	4	5	XXXI	Kolegij izborne skupine	4	7															
																																																																																																																														XXXII	5	7	XXXII	Kolegij izborne skupine	4	5	Kolegij izborne skupine	4	5	XXXII	Kolegij izborne skupine	4	7	
																																																																																																																																												XXXIII
XXXIV	5	7	XXXIV	Kolegij izborne skupine	4	5	Kolegij izborne skupine	4	5	XXXIV	Kolegij izborne skupine	4	7																																																																																																																															
														XXXV	5	7	XXXV	Kolegij izborne skupine	4	5	Kolegij izborne skupine	4	5	XXXV	Kolegij izborne skupine	4	7																																																																																																																	
																												XXXVI	5	7	XXXVI	Kolegij izborne skupine	4	5	Kolegij izborne skupine	4	5	XXXVI	Kolegij izborne skupine	4	7																																																																																																			
																																										XXXVII	5	7	XXXVII	Kolegij izborne skupine	4	5	Kolegij izborne skupine	4	5	XXXVII	Kolegij izborne skupine	4	7																																																																																					
																																																								XXXVIII	5	7	XXXVIII	Kolegij izborne skupine	4	5	Kolegij izborne skupine	4	5	XXXVIII	Kolegij izborne skupine	4	7																																																																							
																																																																						XXXIX	5	7	XXXIX	Kolegij izborne skupine	4	5	Kolegij izborne skupine	4	5	XXXIX	Kolegij izborne skupine	4	7																																																									
																																																																																				XL	5	7	XL	Kolegij izborne skupine	4	5	Kolegij izborne skupine	4	5	XL	Kolegij izborne skupine	4	7																																											
																																																																																																		XLI	5	7	XLI	Kolegij izborne skupine	4	5	Kolegij izborne skupine	4	5	XLI	Kolegij izborne skupine	4	7																													
																																																																																																																XLII	5	7	XLII	Kolegij izborne skupine	4	5	Kolegij izborne skupine	4	5	XLII	Kolegij izborne skupine	4	7															
																																																																																																																														XLIII	5	7	XLIII	Kolegij izborne skupine	4	5	Kolegij izborne skupine	4	5	XLIII	Kolegij izborne skupine	4	7	
																																																																																																																																												XLIV
XLV	5	7	XLV	Kolegij izborne skupine	4	5	Kolegij izborne skupine	4	5	XLV	Kolegij izborne skupine	4	7																																																																																																																															
														XLVI	5	7	XLVI	Kolegij izborne skupine	4	5	Kolegij izborne skupine	4	5	XLVI	Kolegij izborne skupine	4	7																																																																																																																	
																												XLVII	5	7	XLVII	Kolegij izborne skupine	4	5	Kolegij izborne skupine	4	5	XLVII	Kolegij izborne skupine	4	7																																																																																																			
																																										XLVIII	5	7	XLVIII	Kolegij izborne skupine	4	5	Kolegij izborne skupine	4	5	XLVIII	Kolegij izborne skupine	4	7																																																																																					
																																																								XLIX	5	7	XLIX	Kolegij izborne skupine	4	5	Kolegij izborne skupine	4	5	XLIX	Kolegij izborne skupine	4	7																																																																							
																																																																						L	5	7	L	Kolegij izborne skupine	4	5	Kolegij izborne skupine	4	5	L	Kolegij izborne skupine	4	7																																																									
																																																																																				LI	5	7	LI	Kolegij izborne skupine	4	5	Kolegij izborne skupine	4	5	LI	Kolegij izborne skupine	4	7																																											
																																																																																																		LII	5	7	LII	Kolegij izborne skupine	4	5	Kolegij izborne skupine	4	5	LII	Kolegij izborne skupine	4	7																													
																																																																																																																LIII	5	7	LIII	Kolegij izborne skupine	4	5	Kolegij izborne skupine	4	5	LIII	Kolegij izborne skupine	4	7															
																																																																																																																														LIV	5	7	LIV	Kolegij izborne skupine	4	5	Kolegij izborne skupine	4	5	LIV	Kolegij izborne skupine	4	7	
																																																																																																																																												LV
LVI	5	7	LVI	Kolegij izborne skupine	4	5	Kolegij izborne skupine	4	5	LVI	Kolegij izborne skupine	4	7																																																																																																																															
														LVII	5	7	LVII	Kolegij izborne skupine	4	5	Kolegij izborne skupine	4	5	LVII	Kolegij izborne skupine	4	7																																																																																																																	
																												LVIII	5	7	LVIII	Kolegij izborne skupine	4	5	Kolegij izborne skupine	4	5	LVIII	Kolegij izborne skupine	4	7																																																																																																			
																																										LX	5	7	LX	Kolegij izborne skupine	4	5	Kolegij izborne skupine	4	5	LX	Kolegij izborne skupine	4	7																																																																																					
																																																								LXI	5	7	LXI	Kolegij izborne skupine	4	5	Kolegij izborne skupine	4	5	LXI	Kolegij izborne skupine	4	7																																																																							
																																																																						LXII	5	7	LXII	Kolegij izborne skupine	4	5	Kolegij izborne skupine	4	5	LXII	Kolegij izborne skupine	4	7																																																									
																																																																																				LXIII	5	7	LXIII	Kolegij izborne skupine	4	5	Kolegij izborne skupine	4	5	LXIII	Kolegij izborne skupine	4	7																																											
																																																																																																		LXIV	5	7	LXIV	Kolegij izborne skupine	4	5	Kolegij izborne skupine	4	5	LXIV	Kolegij izborne skupine	4	7																													
																																																																																																																LXV	5	7	LXV	Kolegij izborne skupine	4	5	Kolegij izborne skupine	4	5	LXV	Kolegij izborne skupine	4	7															
																																																																																																																														LXVI	5	7	LXVI	Kolegij izborne skupine	4	5	Kolegij izborne skupine	4	5	LXVI	Kolegij izborne skupine	4	7	
																																																																																																																																												LXVII

**POSlijEDIPLOMSKI SVEUČILIŠNI (DOKTORSKI) STUDIJ IZ PODRUČJA TEHNIČKIH ZNANOSTI, POLJA STROJARSTVA, BRODOGRADNJE, TEMELJNIH TEHNIČKIH ZNANOSTI, INTERDISCIPLINARNIH TEHNIČKIH ZNANOSTI, ELEKTROTEHNIKE I RAČUNARSTVA**

Na Tehničkom fakultetu izvode se tri poslijediplomska sveučilišna (doktorska) studija iz tehničkih znanosti - polja strojarstva, brodogradnje, temeljnih tehničkih znanosti i interdisciplinarnih tehničkih znanosti, polja elektrotehnike te polja računarstva.

Završetkom ovih studija student stječe stupanj doktora znanosti što podrazumijeva superiorno poznavanje određenog znanstvenog područja unutar tehničkih znanosti i dokazanu sposobnost originalnog znanstvenog istraživanja. Njegove kompetencije obuhvaćaju vrsno poznavanje literature i nerazjašnjenih problema iz određenog područja te sposobnost osmišljavanja i provođenja znanstvenoistraživačkog projekta do kraja, objavljivanja rezultata istraživanja te prezentiranja tih rezultata drugim znanstvenicima, izražavanja svojih stavova u prisutnosti eksperta u području (na kongresima, seminarima, gostovanjima na drugim institucijama itd.). Njegove osobine obuhvaćaju i želju za dijeljenjem svojega znanja i iskustva mlađim generacijama studenata, kritičnost, u prvom redu prema vlastitom istraživanju, ali i radu drugih te sposobnost prilagođavanja dolazećim promjenama.

Nakon završetka doktorskog studija otvaraju se brojne mogućnosti nastavka znanstveno-istraživačkog rada na matičnoj instituciji ili srodnim institucijama u Hrvatskoj ili inozemstvu, kao i postdoktorskog usavršavanja. Otvaraju se i mogućnosti zapošljavanja u javnom i privatnom sektoru, posebno u onim gospodarskim subjektima s kojima Fakultet ima razvijenu suradnju, ali i drugdje u Hrvatskoj i inozemstvu.

Doktorski studij sastoji se od:

- » provedbe znanstvenoistraživačkog rada pod nadzorom i uz pomoć mentora, odnosno sumentora koja rezultira izradom doktorske disertacije (90 ECTS bodova),
- » polaganja obveznih i izbornih predmeta propisanih studijskim programom doktorskog studija (42 ECTS bodova),
- » boravka na drugim domaćim ili inozemnim sveučilišnim ili znanstvenim institucijama u trajanju od najmanje 3 mjeseca (20 ECTS bodova),

**POSTGRADUATE DOCTORAL STUDIES IN THE FIELD OF ENGINEERING SCIENCES, IN THE SUBJECTS OF MECHANICAL ENGINEERING, NAVAL ARCHITECTURE, FUNDAMENTAL ENGINEERING SCIENCES, INTERDISCIPLINARY ENGINEERING SCIENCES, ELECTRICAL ENGINEERING AND COMPUTER SCIENCE**

At the Faculty of Engineering there are three postgraduate doctoral studies in the field of Engineering Sciences, first one in the subjects of Mechanical Engineering, Naval Architecture, Fundamental Engineering Sciences and Interdisciplinary Engineering Sciences; second one in the subject of Electrical Engineering, and the third one in the subject of Computer Science.

With the completion of the studies, the student gains the academic degree of Doctor of Science, has a superior knowledge of a particular scientific field within the engineering sciences and he will have proven to have the capability to and has proven to have original scientific research. His competences cover comprehension of literature and unsolved problems of a particular area and the ability to conduct a scientific project up to its completion, to publish the research results and to present these results to other scientists, the ability to express his opinion in the presence of experts in the research area (at conferences and similar gatherings). His characteristics include the desire to transfer his knowledge to the younger generations, criticism, in the first place towards his own work, but also towards the work of others and the ability to adapt to imminent changes.

Upon completion of the doctoral study, numerous possibilities for the continuation scientific work are present at the Faculty Engineering or other institutions in Croatia and abroad, as well as the possibility to continue education in postdoctoral study. Also, the possibility of finding an occupation in the public as well as in the private business sector becomes available (e.g., entities with whom the Faculty of Engineering has developed collaboration) as well as in other enterprises in Croatia and abroad.

The doctoral study consists of:

- » scientific research work under the guidance and help of a mentor and possibly a co-mentor, which results in the completion of a doctoral dissertation (90 ECTS credits),
- » sitting examinations for all obligatory and elective courses prescribed by the curriculum of the doctoral study (42 ECTS credits),

- » drugih aktivnosti koje obuhvaćaju prezentaciju znanstvenih rezultata na domaćim i međunarodnim znanstvenim skupovima, objavljivanje znanstvenih radova (28 ECTS bodova).

Nastava doktorskog programa iz područja tehničkih znanosti, polja strojarstva, brodogradnje, temeljnih tehničkih znanosti i interdisciplinarnih tehničkih znanosti organizirana je u sedam modula:

1. Proizvodno strojarstvo
2. Termoeenergetika
3. Računarska mehanika
4. Projektiranje i gradnja plovni objekata
5. Konstruiranje u strojarstvu
6. Osiguranje kvalitete i vođenje tehničkih sustava
7. Ekološko inženjerstvo i zaštita okoliša

Nastava doktorskog programa iz područja tehničkih znanosti, polja elektrotehnike organizirana je u dva modula:

1. Elektroničko-informacijski sustavi
2. Elektroenergetika i nove tehnologije

Nastava doktorskog programa iz područja tehničkih znanosti, polja računarstva organizirana je unutar modula Računarstvo.

- » visiting other Croatian or foreign universities or scientific institutions in the duration of at least three months (20 ECTS credits),
- » other activities that include the presentation of scientific research results at national or international scientific gatherings or the writing of scientific papers (28 ECTS credits).

The curriculum of the doctoral study the area of Engineering Sciences, in the fields of Mechanical Engineering, Naval Architecture, fundamental Engineering Sciences and Interdisciplinary Sciences comprises seven modules:

1. Production Technologies in Mechanical Engineering
2. Thermal Energy Engineering
3. Computational Mechanics
4. Design and Building of Naval Vessels
5. Mechanical Engineering Design
6. Quality Assurance and Technical System Management
7. Ecological Engineering and Environmental Protection

The curriculum of the doctoral study in the area of Engineering Sciences, in the field of Electrical Engineering comprises two modules:

1. Electronic and information systems
2. Power Engineering and New Technologies

The curriculum of the doctoral study in the area of Engineering Sciences, in the field of Computer Science comprises the module Computer Science.





Poslijediplomski sveučilišni (doktorski) studij							
Područje tehničke znanosti, polje strojarstvo, brodogradnja, temeljne tehničke znanosti i interdisciplinarne tehničke znanosti							
Metodologija znanstvenistraživačkog rada							
Matematičko modeliranje i numeričke metode							
Statističke metode i stohastički procesi							
Slobodni kolegiji							
Modul	Proizvodno strojarstvo	Termoenergetika	Računarska mehanika	Projektiranje i gradnja plovinskih objekata	Konstruiranje u strojarstvu	Osiguranje kvalitete i vođenje tehničkih sustava	
	CAM, CAP, CAD/NC-CIM	Numeričko modeliranje procesa izgaranja	Elastomehanika i plastomehanika	Opremanje plovinih i pučinskih objekata	Specijalni mehanički prijenosnici	Osiguranje kvalitete i vođenje tehničkih sustava	Ehološko inženjstvo i zaštita okoliša
	Deformabilnost i suvremeno oblikovanje deformiranjem	Numeričko modeliranje prijelaza topline	Ne-linearna analiza konstrukcija	Metodologija projektiranja plovinskih objekata	Principi konstrukcija visokih i ultravisokih preciznosti	Planiranje i vođenje proizvodnje	Upravljanje održivim razvojem i zaštita okoliša
	Toplinska obrada i inženjstvo površina	Ekperimentalne metode u toplinskoj tehnici i termoenergetici	IP iz termomehanike	Pomorstvenost i upravljivost plovinskih objekata	Modeliranje oštećenja i analiza nosivosti elemenata i sklopova	Statistička kontrola procesa	Zaštita mora i priobalja
	Metode simulacije u proizvodnji	Numeričko modeliranje u tehnici hlađenja	IP iz otpora plovinskih objekata	IP iz otpora plovinskih objekata	IP iz znanosti o konstruiranju	Projektiranje baze podataka	Ispitivanje materijala
	Inteligentni roboti i manipulatori	IP iz izmjerljivača topline	Zaštita od buke i vibracija	Modeliranje nestacionarnog strujanja u cevovodima	Modeliranje naprednih inženjerskih konstrukcija iz inovativnih materijala	Poslovno odlučivanje	Gospodarenje otpadom
	IP iz mehaničkog ponašanja i zamora materijala	IP iz grijanja i klimatizacije	Modeliranje nestacionarnog strujanja u cevovodima	IP iz propulzije plovinskih objekata	Napredne metode regulacije u preciznom inženjstvu	Pouzdanost tehničkih sustava	Onečišćenje bukom
	Mehanika oštećenja i prijeloma materijala	Primjena mjera energetske učinkovitosti	Strujanje slobodnom površinom	IP iz dinamike plovinskih objekata	IP iz transportnih sredstava u industriji	Projektni menadžment u razvoju proizvoda i proizvodnih sustava	Računaino modeliranje širenja onečišćenja
	Korozija i zaštita od korozije	IP iz motora s unutarnjim izgaranjem	Turbulentno strujanje	IP iz osnivanja plovinskih objekata	Podatljivi elementi i mehanizmi	Inteligentni sustavi	Numeričko modeliranje strujanja u okolišu
	Razvojni i proizvodni management	IP iz obnovljivih izvora energije	Mehanika kompozitnih konstrukcija	IP iz projektiranja strukture pomorskih konstrukcija	IP iz konstrukcijskih elemenata	Strateški menadžment i konkurentnost	Zaštita okoliša u tehnici hlađenja
	IP iz fleksibilnih proizvodnih sustava	Trajnost i pouzdanost termoenergetskih sustava	Nanomehanika		Viebrinski mehaniki pretvarači	Inženjstvo kvalitete	Inženjstvo zaštite okoliša u energetici i industriji
	IP iz konvencionalne obrade odvajanjem čestica	IP iz brodskih energetskih postrojenja	Dinamika nelinearnih mehaničkih sustava		IP iz hidrosustavskih i pneumatskih prijenosnika	Sigurnost tehničkih sustava	Mikrobiološko onečišćenje u vodama
	IP iz nekonvencionalnih postupaka obrade	IP iz brodskih strojnih kompleksa	Cjelovitost konstrukcija				
	Optimizacija tehnoloških procesa	IP iz toplinskih turbostrojeva	Računarska analiza stabilnosti konstrukcija				
	Planiranje i vođenje proizvodnje	Termodinamička analiza procesa	Računarska mehanika fluida				
	Održiva proizvodnja	IP iz tehnike hlađenja	Hidrodinamika turbostrojeva				
	Inteligentni proizvodni sustavi	Suvremene konstrukcije motora					
	Ispitivanje materijala	IP iz toplinskih znanosti					
	Optimizacija energetske sustava						

Predmeti po modulima



Postgraduate University (Doctoral) Study									
Faculty of Engineering Sciences, Faculty of Mechanical Engineering, Naval Architecture, Fundamental Engineering Sciences and Interdisciplinary Sciences									
Mechanics of Structures, Mechanics of Machines and Mechanisms, Mathematical Modelling and Numerical Methods									
Optimization Methods and Stochastic Processes									
Freely selected course									
Common courses	Production Engineering	Thermal Power Engineering	Computational Mechanics	Design and Building of Naval Vessels	Mechanical Engineering Design	Quality Assurance and Engineering System Control	Ecological Engineering and Environmental Protection		
	CAM, CAP, CAD/NC-CIM	Numerical modelling of combustion processes	Elastomechanics and Plastomechanics	Outfitting of marine vessels and offshore structures	Special mechanical transmissions	Total quality management	Selected Topics on Environment Protection		
	Formability and modern forming technology	Numerical Modelling of Heat Transfer	Nonlinear structural analysis	Ship's design methodology	Principles of High- and Ultra-high Precision Devices	Production planning and control	Sustainable development management and environmental protection		
	Heat treatment and surface engineering	Experimental methods in heating and energy engineering	Selected chapters on thermomechanics	Seakeeping and maneuverability	Damage modeling and load carrying capacity analysis of elements and components	Statistical Process Control	Protection of marine and coastal environments		
	Simulation methods in production	Numerical modelling in refrigeration	Vibrations and durability of machines and structures	Selected chapters on ship resistance	Selected Chapters on Design Science	Design of Data Base	Materials testing		
	Intelligent robots and manipulators	Selected chapters on heat exchangers	Protection from noise and vibrations	Selected chapters on shipbuilding methodology	Design of advanced engineering constructions made of innovative materials	Business Decision-making	Waste management		
	Selected Chapters on Mechanical Behaviour and Fatigue of Materials	Selected chapters on heating and air conditioning	Unsteady Pipe Flow Modeling	Selected chapters on ship propulsion	Advanced control methods in precision engineering	Project management in product and production systems development	Noise pollution		
	Damage and fracture mechanics	Implementation of energy efficiency measures	Free surface flow	Selected topics in marine dynamics	Selected chapters on industrial transport equipment and devices	Reliability of Technical Systems	Computational modelling of pollution dispersion		
	Corrosion and corrosion protection	Selected chapters on internal combustion engines	Turbulent flow	Selected chapters on ship's design	Compliant Elements and Mechanisms	Intelligent Systems	Numerical modelling of environmental flow		
	Development and operations management	Selected chapters on renewable energy sources	Mechanics of composite structures	Selected chapters on marine structural design	Selected chapters on machine elements design	Strategic management and competitiveness	Environmental Refrigeration		
	Selected chapters on flexible manufacturing systems	Durability and reliability of thermal energy systems	Nanomechanics	Multi-speed mechanical converters	Selected chapters on gear transmissions	Quality Engineering	Environment protection in energy and process industry		
	Conventional Machining Processes	Selected chapters on marine energy systems	Dynamics of nonlinear mechanical systems	Selected chapters on gear transmissions	Selected chapters on fluid power	Technical systems safety	Microbiological pollution of water		
	Selected Chapters on Non-Conventional Machining Processes	Selected chapters on marine machinery systems	Structural integrity	Selected chapter on fluid power					
	Processes plans optimization	Selected chapters on thermal turbomachines	Computational structural stability analysis						
	Production Planning and Control	Thermodynamic analysis of processes	Computational fluid mechanics						
	Sustainable manufacturing	Selected chapters on refrigeration	Turbomachinery hydrodynamics						
	Intelligent manufacturing systems	Modern engine design							
	Materials testing	Selected Topics on Thermal Sciences							
	Optimization of energy systems								

Poslijediplomski sveučilišni (doktorski) studij		
Područje tehničke znanosti, polje elektrotehnika		
Zajednički predmeti	Metodologija znanstvenoistraživačkog rada	
	Matematičko modeliranje i numeričke metode	
	Metode optimizacije	
	Statističke metode i stohastički procesi	
	Slobodni kolegij	
Moduli	Elektroničko-informacijski sustavi	Elektroenergetika i nove tehnologije
Predmeti po modulima	Mješovita obrada signala	Energetska efikasnostelektroenergetici
	Elektromagnetsko modeliranje	Modeliranje sustava za distribuciju i potrošnju električne energije
	Fotoničke komponente	Pouzdanost tehničkih sustava
	Mjerenje i analiza kvalitete električne energije	Sustavi upravljanja sinkronim strojevima
	Inteligentni proizvodni sustavi	Optimiranje u elektroenergetskom sustavu
	Inteligentni roboti i manipulatori	Aktivne distribucijske mreže
	Analiza i obrada nestacionarnih signala	Inteligentni elektroenergetski sustavi – Smart Grids
	Ambijentalna inteligencija	Izabrana poglavlja iz energetske komponenti i sustava obnovljivih izvora energije
	Napredne metode digitalne obrade signala	Elementi energetske tranzicije
	Industrijski digitalni sustava upravljanja	
	Uslužna robotika	

Poslijediplomski sveučilišni (doktorski) studij	
Područje tehničke znanosti, polje računarstvo	
Zajednički predmeti	Metodologija znanstvenoistraživačkog rada
	Matematičko modeliranje i numeričke metode
	Metode optimizacije
	Statističke metode i stohastički procesi
	Slobodni kolegij
Modul	Računarstvo
Predmeti	Teorija informacija s primjenama
	Primijenjeno strojno učenje
	Oblikovanje i vrednovanje naprednih interaktivnih sustava
	Odabrana poglavlja iz komunikacijskih mreža
	Računalna percepcija
	Nosivo računarstvo
	Inteligentni sustavi
	Uslužna robotika
Uvod u meko računarstvo i primjene	



Postgraduate University (Doctoral) Study		
Area of Engineering Sciences, Field of Electrical Engineering		
Common courses	Methodology of Scientific Work and Research	
	Mathematical Modelling and Numerical Methods	
	Optimization Methods	
	Statistical Methods and Stochastic Processes	
	Freely selected course	
Modules	Electronic-Information Systems	Electric Power Systems and New Technologies
Module courses	Mixed signal processing	Energy efficiency in electrical systems
	Electromagnetic Modelling	Modelling of Electrical Power Transmission and Distribution Systems
	Photonic Devices	Reliability of Technical Systems
	Measurement and Analysis of Electric Power Quality	Control of Synchronous Machines
	Intelligent manufacturing systems	Power system optimization
	Intelligent robots and manipulators	Active Distribution Networks
	Nonstationary Signal Analysis and Processing	Intelligent Power Systems - Smart Grids
	Ambient intelligence	Selected Chapters on Energy Components and Systems of Renewable Energy Sources
	Advanced Digital Signal Processing Methods	The elements of energy transition
	Industrial digital control system	
	Service robotics	



Postgraduate University (Doctoral) Study	
Area of Engineering Sciences, Field of Computer Science	
Common courses	Methodology of Scientific Work and Research
	Mathematical Modelling and Numerical Methods
	Optimization Methods
	Statistical Methods and Stochastic Processes
	Freely selected course
Module	Computer Science
Courses	Information Theory with Applications
	Applied Machine Learning
	Advanced Interactive Systems Design and Evaluation
	Selected Chapters from Communication Networks
	Computer Perception
	Wearable Computing
	Intelligent Systems
	Service Robotics
Introduction to Soft Computing and Applications	

**PREDDIPLOMSKI STRUČNI STUDIJ STROJARSTVA**

Preddiplomski stručni studij strojarstva ima za cilj osposobljavanje stručnjaka strojarstva za rad na izvršavanju složenih operativnih poslova kod razrade projekata strojarstvenih konstrukcija, odnosno složenih operativnih poslova planiranja, pripreme, unapređenja i kontrole tehnoloških i proizvodnih procesa i planiranja, organiziranja i vođenja proizvodnih, odnosno energetskih postrojenja. Pri tome je njihovo radno mjesto prvenstveno u pogonu, odnosno terenu, a u manjoj mjeri u uredu.

Odluči li se student za nastavak studija, on će biti moguć na onim ustanovama koje nude diplomski stručni studij strojarstva. Također, bit će moguć nastavak na diplomskom sveučilišnom studiju strojarstva Tehničkog fakulteta Sveučilišta u Rijeci prema posebnim uvjetima upisa koje određuje Fakultetsko vijeće.

**PREDDIPLOMSKI STRUČNI STUDIJ BRODOGRADNJE**

Preddiplomski stručni studij brodogradnje ima za cilj osposobljavanje stručnjaka brodogradnje za rad na izvršavanju složenih operativnih poslova kod razrade projekata plovih objekata i objekata morske tehnologije i njihovih elemenata, odnosno složenih operativnih poslova planiranja, pripreme, unapređenja i kontrole procesa gradnje plovih objekata. Pri tome je njegovo radno mjesto prvenstveno u proizvodnji, a u manjoj mjeri u uredu.

Odluči li se student za nastavak studija, on će biti moguć na onim ustanovama koje nude diplomski stručni studij brodogradnje. Također, bit će moguć nastavak na diplomskom sveučilišnom studiju brodogradnje Tehničkog fakulteta Sveučilišta u Rijeci prema posebnim uvjetima upisa koje određuje Fakultetsko vijeće.

**PREDDIPLOMSKI STRUČNI STUDIJ ELEKTROTEHNIKE**

Preddiplomski stručni studij elektrotehnike ima za cilj osposobljavanje stručnjaka elektrotehnike za sudjelovanje u projektiranju i konstruiranju elemenata postrojenja, za ispitivanje i održavanje električnih strojeva i uređaja, elektroničkih industrijskih uređaja i uređaja industrijske automatizacije, te industrijskih i elektroenergetskih postrojenja. Pri tome je njegovo radno mjesto prvenstveno u pogonu, odnosno terenu, a u manjoj mjeri u uredu.

Odluči li se student za nastavak studija, on će biti moguć na onim ustanovama koje nude diplomski stručni studij elektrotehnike. Također, bit će moguć nastavak na diplomskom sveučilišnom studiju elektrotehnike Tehničkog fakulteta Sveučilišta u Rijeci prema posebnim uvjetima upisa koje određuje Fakultetsko vijeće.

**UNDERGRADUATE VOCATIONAL STUDY OF MECHANICAL ENGINEERING**

The aim of the undergraduate vocational study in Mechanical Engineering is to train experts in mechanical engineering to carry out complex operational tasks in technical systems projects, that is, complex operational tasks of planning, preparing, improving, and controlling technological and production processes, and planning, organising, and overseeing production and power facilities. The job position is primarily in the plant room, in the field, and to a lesser extent, in the office. If students decide to continue their studies, they can do this at those institutions offering graduate vocational study in mechanical engineering. In addition, they can continue their studies at the graduate university study of mechanical engineering at the Faculty of Engineering in Rijeka in line with special admission requirements set by the Faculty Council.

**UNDERGRADUATE VOCATIONAL STUDY OF NAVAL ARCHITECTURE**

The aim of the undergraduate vocational study in naval architecture is to train experts in naval architecture to carry out complex operational tasks in the projects of ships and marine technology objects and their elements, that is, complex operational tasks of planning, preparing, improving, and controlling the process of building ships. The job position is primarily in production and to a lesser extent in the office. If students decide to continue their studies, they can do this at those institutions offering graduate vocational study in naval architecture. In addition, they can continue their studies at the graduate university study of naval architecture at the Faculty of Engineering in Rijeka in line with special admission requirements set by the Faculty Council.

**UNDERGRADUATE VOCATIONAL STUDY OF ELECTRICAL ENGINEERING**

The aim of the undergraduate vocational study in electrical engineering is to train experts in electrical engineering to participate in designing and building plant parts, to inspect and maintain electrical machines and devices, electronic industrial devices and industrial automation devices, and industrial and electric power plants. The job position is primarily in the plant room, in the field, and to a lesser extent, in the office. If students decide to continue their studies, they can do this at those institutions offering graduate vocational study in electrical engineering. In addition, they can continue their studies at the graduate university study of electrical engineering at the Faculty of Engineering in Rijeka in line with special admission requirements set by the Faculty Council.

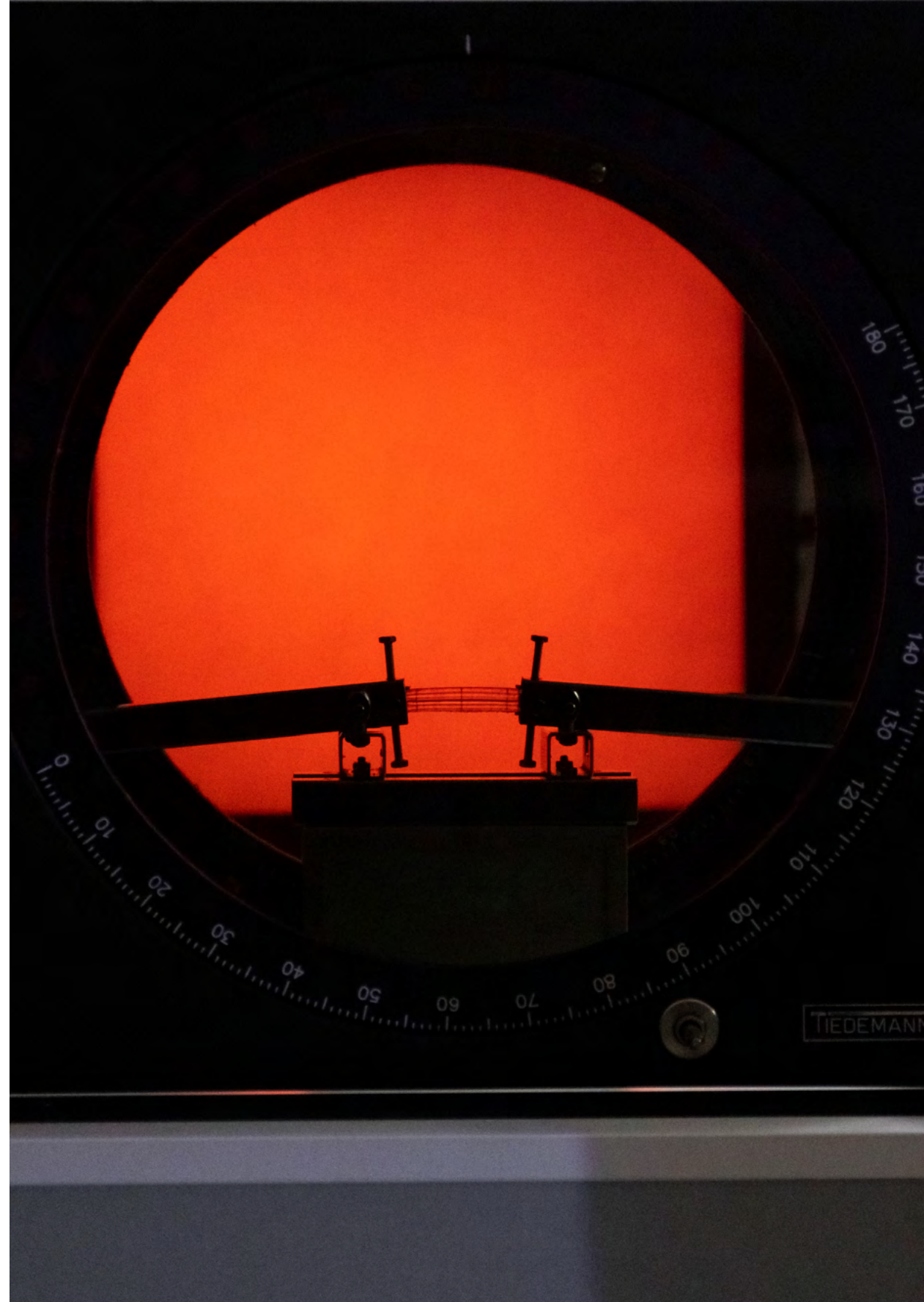



Preddiplomski stručni studiji											
S	Strojlarstvo			S			Brodogradnja			S	
	Predmet	N	B	Predmet	N	B	Predmet	N	B	Predmet	N
I	Matematika I	5	7	I	Matematika I	5	7	I	Matematika I	5	7
	Mehanika I	5	7	I	Mehanika I	5	7	I	Fizika	5	7
	Materijali	4	6	I	Materijali	4	6	I	Osnove elektrotehnike ST I	5	8
	Osnove elektrotehnike	3	5	I	Osnove elektrotehnike	3	5	I	Materijali i tehnološki postupci	3	4
	Primjena računala ST	3	5	I	Primjena računala ST	3	5	I	Primjena računala ST	3	5
	Matematika II	5	7	II	Matematika II	5	7	II	Matematika II	5	7
	Mehanika II	4	6	II	Mehanika II	4	6	II	Osnove elektrotehnike ST II	5	7
	Čvrstoća	4	6	II	Čvrstoća	4	6	II	Digitalna logika ST	4	6
	Tehničko crtanje	4	6	II	Tehničko crtanje	4	6	II	Mehanika i elementi konstrukcija ST	3	5
	Tehnologija obrade I	3	5	III	Plovnih objekti	3	5	III	Tehničko dokumentiranje	3	5
II	Organizacija i ekonomika	3	4	III	Organizacija i ekonomika	3	4	III	Mjerenja u elektrotehnici ST	5	7
	Mehanika fluida ST	3	5	III	Mehanika fluida ST	3	5	III	Elekt. komp. i osnovni sklopovi	5	7
	Toplina	4	6	III	Toplina	4	6	III	Linearne električne mreže	4	7
	Tehnologija obrade II	4	6	III	Brodске forme ST	4	7	III	Mehatronika	4	6
	Elementi strojeva I	4	6	III	Zavarivanje	3	5	III	Strani jezik I	2	3
	Strani jezik I	2	3	III	Strani jezik I	2	3	III			
	Elementi strojeva II	4	6	IV	Hidrostatika broda	4	6	IV	Osnove energetske elektronike	5	7
	Obradni strojevi	3	5	IV	Strukturalni elementi broda	4	6	IV	Osnove automatske regulacije	4	7
	Toplinski strojevi i uređaji I	3	5	IV	Tehnologija brodogradnje I	3	5	IV	Kolegij izborne skupine	5	8
	Strani jezik II	2	3	IV	Elementi strojeva I BG	3	5	IV	Strani jezik II	2	3
III	Stručna praksa I	4	6	IV	Stručna praksa I	4	6	IV	Stručna praksa I	5	
	Kolegij izborne skupine	4	6	IV	Stručna praksa I	4	6	IV			
	Mjerna tehnika ST	3	5	V	Mjerna tehnika ST	3	5	V	Organizacija i ekonomika	3	4
	Toplinski strojevi i uređaji II	3	5	V	Tehnologija brodogradnje II	3	5	V	Kolegij izborne skupine	5	7
	Hidraulički strojevi	3	5	V	Tehn. procesi gradnje i remonta broda	3	5	V	Kolegij izborne skupine	4	7
	Zavarivanje	3	5	V	Konstrukcija broda	4	6	V	Kolegij izborne skupine	4	6
	Kolegij izborne skupine	4	5	V	Oprema broda ST	4	7	V	Kolegij izborne skupine	4	6
	Kolegij izborne skupine	4	5	V							
	Slobodni kolegij	4	5	VI	Gradnja i održavanje malih plovnih objekata	4	5	VI	Slobodni kolegij	4	5
	Stručna praksa II	4	5	VI	Slobodni kolegij	4	5	VI	Stručna praksa II	10	10
IV	Kolegij izborne skupine	4	5	VI	Stručna praksa II	4	5	VI	Kolegij izborne skupine	4	5
	Završni rad	4	5	VI	Završni rad	4	5	VI	Završni rad	10	10

Undergraduate Vocational Studies											
S	Mechanical Engineering			S			Naval Architecture			S	
	Course	N	B	Course	N	B	Course	N	B	Course	N
I	Mathematics I	5	7	I	Mathematics I	5	7	I	Mathematics I	5	7
	Mechanics I	5	7	I	Mechanics I	5	7	I	Physics	4	6
	Materials	4	6	I	Materials	4	6	I	Fundamentals of Electrical Engineering VO I	5	8
	Fundamentals of Electrical Engineering	3	5	I	Fundamentals of Electrical Engineering	3	5	I	Materials and Production Processes	3	4
	Applied Computing VO	3	5	I	Applied Computing VO	3	5	I	Applied Computing VO	3	5
	Mathematics II	5	7	II	Mathematics II	5	7	II	Mathematics II	5	7
	Mechanics II	4	6	II	Mechanics II	4	6	II	Fundamentals of Electrical Engineering VO II	5	7
	Strength of Materials	4	6	II	Strength of Materials	4	6	II	Digital Logic VO	4	6
	Technical Drawing	4	6	II	Technical Drawing	4	6	II	Mechanics and Structural Elements VO	3	5
	Manufacturing Technology I	3	5	III	Marine Vessels	3	5	III	Technical Documenting	3	5
II	Organization and Economics	3	4	III	Organization and Economics	3	4	III	Measurements in Electrical Engineering VO	5	7
	Fluid Mechanics VO	3	5	III	Fluid Mechanics VO	3	5	III	Semiconductor Devices and Basic Microel. Circu.	5	7
	Thermodynamics	4	6	III	Thermodynamics	4	6	III	Linear Electrical Circuits	4	7
	Manufacturing Technology II	4	6	III	Ship Hull Forms VO	4	7	III	Mechatronics	4	6
	Machine Elements I	4	6	III	Welding Engineering	3	5	III	Foreign Language I	2	3
	Foreign Language I	2	3	III	Foreign Language II	2	3	III			
	Machine Elements II	4	6	IV	Ship Hydrostatics	4	6	IV	Fundamentals of Power Electronics	5	7
	Machine Tools	3	5	IV	Ship Structure	4	6	IV	Fundamentals of Automatic Regulation	4	7
	Heat Engines and Devices I	3	5	IV	Shipbuilding Technology I	4	6	IV	Elective group course	5	8
	Foreign Language II	2	3	IV	Machine Elements I NA	3	5	IV	Foreign Language II	2	3
III	Professional Practice I	5		IV	Foreign Language II	2	3	IV	Professional Practice I	5	
	Elective group course	4	6	IV	Professional Practice I	4	6	IV			
	Measuring Technology VO	3	5	V	Measuring Technology VO	3	5	V	Organization and Economics	3	4
	Heat Engines and Devices II	3	5	V	Shipbuilding Technology II	5	6	V	Elective group course	5	7
	Hydraulic Machines VO	3	5	V	Technological Processes of Ship Production and Rep	5	6	V	Elective group course	4	7
	Welding Engineering	3	5	V	Ship Construction	4	6	V	Elective group course	4	6
	Elective group course	4	5	V	Ship Equipment VO	4	7	V	Elective group course	4	6
	Elective group course	4	5	V							
	Free Elective Course	4	5	VI	Small Craft Building and Maintenance	4	5	VI	Free Elective Course	4	5
	Professional Practice II	4	5	VI	Free Elective Course	4	5	VI	Professional Practice II	10	10
IV	Elective group course	4	5	VI	Professional Practice II	4	5	VI	Elective group course	4	5
	Final Work	4	5	VI	Final Work	4	5	VI	Final Work	10	10

# 4 DEKANAT DEAN'S OFFICE

Sveučilište u Rijeci, Tehnički fakultet  
University of Rijeka, Faculty of Engineering,  
Croatia

Vukovarska 58, 51000 Rijeka  
Hrvatska | Croatia

[www.riteh.uniri.hr](http://www.riteh.uniri.hr) | [dekanat@riteh.hr](mailto:dekanat@riteh.hr)



## PRODEKANI | VICE-DEANS:

prof. dr. sc. / Prof. D. Sc. **Anica Trp**  
nastava | academics

prof. dr. sc. / Prof. D. Sc. **Marina Franulović**  
znanstvena djelatnost | research activities

izv. prof. dr. sc. / Assoc. Prof. D. Sc. **Ivan Štajduhar**  
poslovni odnosi | business affairs

## DEKAN | DEAN:

prof. dr. sc. / Prof. D. Sc.  
**Duško Pavletić**

## POMOĆNICI DEKANA | DEAN'S ASSISTANTS:

izv. prof. dr. sc. / Assoc. Prof. D. Sc. **Neven Bulić**

izv. prof. dr. sc. / Assoc. Prof. D. Sc. **Marino Brčić**

## URED DEKANA | DEAN'S OFFICE:

**Sanja Prpić**, dipl. oec. / grad. economist  
voditeljica | head

**Tomo Vergić**, dipl. iur. / grad. law.  
glavni tajnik | secretary general

**Željka Gulić**, mag. oec  
tajnica prodekana | vice dean secretary

ZAVOD ZA AUTOMATIKU  
I ELEKTRONIKU

ZAVOD ZA  
BRODOGRADNJU  
I INŽENJERSTVO MORSKE  
TEHNOLOGIJE

ZAVOD ZA  
ELEKTROENERGIJU

ZAVOD ZA  
FIZIKU, STRUKTURNU  
KINEZIOLOGIJU

ZAVOD

ZAVOD  
FU

# 5 ZAVODI DEPARTMENTS



# 5.

## ZAVOD ZA AUTOMATIKU I ELEKTRONIKU DEPARTMENT OF AUTOMATION AND ELECTRONICS





## DJELATNICI FACULTY AND STAFF

### PREDSTOJNIK ZAVODA | DEPARTMENT HEAD:



Prof. dr. sc. / Prof. D. Sc. **Zlatan Car**

*umjetna inteligencija; inteligentni sustavi; robotika; CNC/NC obradni strojevi i robotika; konstrukcija i optimizacija alata i naprava; simulacija i optimizacija rada sustava i strojeva*

*artificial intelligence; intelligent systems; CNC/NC machines & robotics; design of tools & fixtures; modeling, simulation and optimization of systems and machines*

### REDOVITI PROFESOR U TRAJNOM ZVANJU | TENURED PROFESSOR



**Nino Stojković**

*analogna obrada signala; analogni filtri  
analog signal processing; analog filters*

### REDOVITI PROFESORI | PROFESSORS



**Viktor Sučić**

*analiza i obrada signala  
signal analysis and processing*



**Saša Vlahinić**

*mjerenja u elektrotehnici; mjerenja kvalitete električne energije; elektronička i virtualna instrumentacija; obrada EEG signala; BCI  
electrical measurements; power quality measurements; electronic and virtual instrumentation; EEG signal processing; BCI*



**Miroslav Vrankić**

*digitalna obrada signala i slike; asistivna tehnologija; sučelja mozak-računalo  
digital signal and image processing; assistive technology; brain-computer interfaces*

### IZVANREDNI PROFESORI | ASSOCIATE PROFESSORS

**Neven Bulić**

*automatizacija; elektromotorni pogoni; sustavi digitalnog upravljanja  
automation; electrical drives; digital control systems*



**Vera Gradišnik**

*poluvodička elektronika; optoelektronika; poluvodički elementi; fotosenzori iz amorfnog silicija; tankoslojni fotosenzori u biotehnologiji; digitalna logika  
semiconductor electronics; optoelectronics; semiconductor devices; amorphous silicon photosensors; thin film photosensors in biotechnology; digital logic*



### DOCENT | ASSISTANT PROFESSOR

**Ivan Volarić**

*vremensko-frekvencijska obrada signala; obrada prorijeđenih signala  
time-frequency signal processing; sparse signal processing*



### ASISTENTI | ASSISTANTS

**Nikola Anđelić**

*automatika; umjetna inteligencija; molekularna dinamika; nanomehanika; analogna obrada signala  
automation, artificial intelligence, molecular dynamics, nanomechanics, analog signal processing*



**Sebastijan Blažević**

*automatika  
automation*



**Dominik Cikač**

*automatizacija; elektromotorni pogoni; sustavi digitalnog upravljanja  
automation; electrical drives; digital control systems*



**Vedran Jurdana**

*vremensko-frekvencijska obrada signala; statistička analiza signala  
time-frequency signal processing, statistical signal analysis*



**Ivan Lorencin**

*umjetna inteligencija; automatika; digitalna obrada slika*  
artificial intelligence; automation; digital image processing

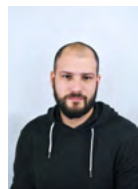
**Ivan Markovinović**

*obrada EEG signala; sučelje mozak-računalo; ICA*  
EEG signal processing; brain-computer interface; ICA

**Zoran Šverko**

*obrada EEG signala; neurofeedback*  
EEG signal processing; neurofeedback

**Nikola Turk**

*automatika; upravljanje elektromotornim pogonima;*  
*bezležajni motori*  
automation; control of electrical drives; bearingless drives

**Nardi Verbanac**

*automatika; upravljanje elektromotornim pogonima;*  
*bezležajni motori*  
automation; control of electrical drives; bearingless drives

**STRUČNI SURADNICI - MLADI ISTRAŽIVAČI | JUNIOR RESEARCHERS****Sandi Baressi Šegota**

*umjetna inteligencija; evolucijska robotika; znanost o podacima*  
artificial intelligence; evolutionary robotics; data science

**Jelena Musulin**

*umjetna inteligencija; digitalna obrada slika; znanost o podacima*  
artificial intelligence; digital image processing; data science

**Daniel Štifanić**

*umjetna inteligencija; znanost o podacima; obrada signala*  
artificial intelligence; data science; signal processing

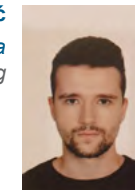
**VANJSKI SURADNICI | ASSOCIATES****Dario Matika**

Ministarstvo obrane

*automatika*  
automation

*Nastava se izvodi iz područja automatike, robotike, elektronike, mjerenja u elektrotehnici, mjerne instrumentacije te obrade signala.*

*Program razlikovne edukacije za upis na diplomski sveučilišni studij elektrotehnike.*

**KOLEGIJI NA PREDDIPLOMSKIM SVEUČILIŠNIM STUDIJIMA**

| UNDERGRADUATE UNIVERSITY COURSES

- Automatizacija
- Automatsko upravljanje
- Digitalna logika
- Električne mreže
- Elektronika
- Elektronika I
- Elektronika II
- Elementi automatizacije postrojenja
- Mjerenja u elektrotehnici
- Modeliranje i simuliranje sustava
- Osnove regulacijske tehnike
- Računalom podržana mjerenja
- Signali i sustavi
- Stručna praksa I

- Automation
- Automatic Control
- Digital Logic
- Electrical Circuits
- Electronics
- Electronics I
- Electronics II
- Elements of Plant Automation
- Electrical Measurements
- System Modelling and Simulation
- Basic of Automatic Control
- Computer Aided Measurement
- Signals and Systems
- Industrial Practice I

**KOLEGIJI NA DIPLOMSKIM SVEUČILIŠNIM STUDIJIMA**

| GRADUATE UNIVERSITY COURSES

- Analogna obrada signala
- Asistivna tehnologija
- Automatizacija postrojenja i procesa
- Automatizirana instrumentacija
- Digitalna obrada signala
- Digitalna obrada slike
- Industrijska robotika
- Mehatronički sustavi
- Optoelektronika
- Osnove robotike
- Primjena umjetne inteligencije

- Analog Signal Processing
- Assistive Technology
- Automation of Plants and Processes
- Automatic Instrumentation
- Digital Signal Processing
- Digital Image Processing
- Industrial robotics
- Mechatronic Systems
- Optoelectronics
- Fundamentals of Robotics
- AI Implementation

**NASTAVA I ZNANOST**  
EDUCATION AND SCIENCE

*Lectures in the field of automatic control, robotics, electronics, electrical measurements, instrumentation and signal processing.*

*Program of lifelong learning for admission to the graduate university study of electrical engineering.*



- Sustavi digitalnog upravljanja
- Sustavi kontrole
- Stručna praksa II
- Evolucijska robotika
- Statistička analiza signala
- Digital Control Systems
- Control Systems
- Industrial Practice II
- Evolutionary Robotics
- Statistical Signal Analysis

**KOLEGIJI NA PREDDIPLOMSKIM STRUČNIM STUDIJIMA**

| UNDERGRADUATE VOCATIONAL COURSES

- Automatizacija ST
- Digitalna logika ST
- Elektroničke komponente i osnovni sklopovi
- Linearne električne mreže
- Mehatronika
- Mjerenja u elektrotehnici ST
- Osnove automatske regulacije
- Automation ST
- Digital Logic ST
- Semiconductors Devices and Basic Electronic Circuits
- Linear Electrical Circuits
- Mechatronics
- Electrical Measurements ST
- Fundamentals of Automatic Regulation

**KOLEGIJI NA POSLIJEDIPLOMSKIM (DOKTORSKIM) SVEUČILIŠNIM STUDIJIMA**

| POSTGRADUATE UNIVERSITY (DOCTORAL) COURSES

- Analiza i obrada nestacionarnih signala
- Fotoničke komponente
- Mjerenje i analiza kvalitete električne energije
- Mješovita obrada signala
- Nelinearni sustavi automatskog upravljanja
- Ambijentalna inteligencija
- Projektiranje digitalnih sustava
- Pouzdanost tehničkih sustava
- Intelligentni proizvodni sustavi
- Roboti i manipulatori
- Nonstationary Signal Analysis and Processing
- Photonic Devices
- Measurement and Analysis of Electric Power Quality
- Mixed Signal Processing
- Nonlinear Control Systems
- Ambient Intelligence
- Digital System Design
- Reliability of Technical Systems
- Intelligent Manufacturing Systems
- Robots and Manipulators

**ZNANSTVENOISTRAŽIVAČKI RAD | SCIENTIFIC RESEARCH**

- Obrada signala  
Signal Processing
- Elektronika  
Electronics
- Mjerenje kvalitete električne energije  
Power quality measurements
- Robotika  
Robotics
- Umjetna inteligencija  
Artificial intelligence
- Automatizacija  
Automation
- Korištenje umjetne inteligencije u modeliranju utjecaja i širenja COVID-19  
Use of Artificial Intelligence in modeling the effects and spread of COVID-19
- Primjena umjetne inteligencije u medicini  
Application of Artificial Intelligence in medicine
- Poluvodički elementi i optoelektronika  
Semiconductor devices and Optoelectronics

**PROJEKTI | PROJECTS**

- CEEPUS; CIII-HR-0108-06-1112 - Concurrent Product and Technology Development - Teaching, Research and Implementation of Joint Programs Oriented in Production and Industrial Engineering ; (EU projekt mobilnosti/voditelj projekta);  
CEEPUS; CIII-HR-0108-06-1112 - Concurrent Product and Technology Development - Teaching, Research and Implementation of Joint Programs Oriented in Production and Industrial Engineering ; (EU mobility project; project manager);
- CEEPUS; CIII-RO-0202-05-1112 - Implementation and utilization of e-learning systems in study area of production engineering in Central European Region; (EU projekt mobilnosti/suradnik na projektu)  
CEEPUS; CIII-RO-0202-05-1112 - Implementation and utilization of e-learning systems in study area of production engineering in Central European Region; (EU mobility project; associate member)
- CEEPUS; CIII-CZ-0201-04-1112 - Knowledge Bridge for Students and Teachers in Manufacturing Technologies; (EU projekt mobilnosti/suradnik na projektu)  
CEEPUS; CIII-CZ-0201-04-1112 - Knowledge Bridge for Students and Teachers in Manufacturing Technologies; (EU mobility project; associate member)
- CEEPUS; CIII-PL-0007-07-1112 - Modern Methods of the Constitution and Measurement of Geometrical Surface Structure; (EU projekt mobilnosti/suradnik na projektu)  
CEEPUS; CIII-PL-0007-07-1112 - Modern Methods of the Constitution and Measurement of Geometrical Surface Structure; (EU mobility project; associate member)
- Q-grid, znanstveno-istraživački projekt financiran od strane industrije Danieli-Systec, Neven Bulić, Dominik Cikać, Nikola Turk, 2014-.
- Q-grid, R&D project financed by industry Danieli-Systec, Neven Bulić, Dominik Cikać, Nikola Turk, 2014-.
- Napredne metode i tehnologije u znanosti o podacima i kooperativnim sustavima (DATACROSS), Znanstveni centar izvrsnosti za znanost o podacima i kooperativne sustave, Sveučilište u Zagrebu, Zagreb, Hrvatska  
Advanced Methods and Technologies in Data Science and Cooperative Systems (DATACROSS), Centre of Research Excellence for Data Science and Advanced Cooperative Systems, University of Zagreb, Zagreb, Croatia
- Rekonstrukcija vremensko-frekvencijske distribucije iz komprimirano uzorkovane domene neodređenosti analiziranog signala, Sveučilište u Rijeci, Rijeka, Hrvatska  
Time-Frequency Distribution Reconstruction from the Signal Compressively Sensed Ambiguity Function, University of Rijeka, Rijeka, Croatia
- HAMAG-BICRO, Program provjere inovativnog koncepta, Sinergijski učinak neurofeedback-a i fotobiomodulacije, Vlahinić Saša, 2020.  
HAMAG-BICRO, Proof of Concept Programme, Synergistic effect of neurofeedback and photobiomodulation, Vlahinić Saša, 2020.
- Znanstvena potpora Sveučilišta u Rijeci, „Razvoj inteligentnog ekspertnog sustava za online dijagnostiku raka mokraćnog mjehura“, potpore 2018., Zlatan Car  
University of Rijeka Scientific Support, "Development of an intelligent expert system for online diagnosis of bladder cancer", grants 2018., Zlatan Car
- Centar Kompetencija za pametne gradove - CEKOM, SmartRI; SmartCity.4DII (KK.01.2.2.03.0004)  
Competence Center for Smart Cities - CEKOM, SmartRI; SmartCity.4DII (KK.01.2.2.03.0004)



- *Centralna Europska inicijativa, "Use of Regressive Artificial Intelligence (AI) and Machine Learning (ML) Methods in Modelling of COVID-19 spread – COVIDAI" (305.6019-20) Central European initiative, "Use of Regressive Artificial Intelligence (AI) and Machine Learning (ML) Methods in Modelling of COVID-19 spread – COVIDAI" (305.6019-20)*
- *Razvojno-edukacijski centar za metalsku industriju – Metalska jezgra Čakovec Development and Educational Centre for the Metal Industry – Metal Centre Čakovec*
- *UNIRI multidisciplinarni COVID-19 projekt, Razvoj inteligentnih sustava za predviđanje medicinskog i ekonomskog utjecaja COVID-19, 2020. - 2021. UNIRI multidisciplinary COVID-19 project, Development of intelligent systems for the prediction of medical and economical effect of COVID-19, 2020. - 2021.*
- *Napredne upravljačke strukture u suvremenim reguliranim elektromotornim pogonima" – Istraživačke potpore Sveučilišta u Rijeci, 2018.- uniri-tehnic-18-74 1207, University of Rijeka Scientific Support, "Advanced control structures for modern electrical drives" .- uniri-tehnic-18-74 1207,*
- *Magnetic geared motor, Multi-firm project (MFP), Basic research part, LCM – Linz, 2019.- Magnetic geared motor, Multi-firm project (MFP), Basic research part, LCM – Linz, 2019.-*
- *Calculation of Transient Voltage Effects in Electric Machines, Multi-firm project (MFP), Basic research part, LCM – Linz 2019.- Calculation of Transient Voltage Effects in Electric Machines ", Multi-firm project (MFP), Basic research part, LCM – Linz 2019.-*

## PUBLIKACIJE | PUBLICATIONS

## RADovi U ČASOPISIMA | JOURNAL PAPERS

- *Šverko, Z.; Stojković, N.; Vlahinić, S.; Markovinović I., Noise and sensitivity comparison for different BP filter designs, Automatika: časopis za automatiku, mjerenje, elektroniku, računarstvo i komunikacije, 0005-1144, 62 (3), 319-330, 2021, Hrvatska*
- *Vlahinić, S.; Franković, D.; Juriša, B.; Zbunjak, Z., Back up Protection Scheme for High Impedance Faults Detection in Transmission Systems based on Synchrophasor Measurements IEEE Transactions on Smart Grid, 1949-3053, 12 (2), 1736 - 1746, 2021, USA*
- *Cikač, D.; Turk, N.; Bulić, N.; Barbanti, S., Pulse Pattern Optimization Based on Brute Force Method for Medium-Voltage Three-Level NPC Converter with Active Front End Electronics ISSN: 20799292, 9 (10), 1-20, 2020, Švicarska*
- *Anđelić, N.; Baressi Šegota, S.; Lorencin, I.; Car, Z., Estimation of gas turbine shaft torque and fuel flow of a CODLAG propulsion system using genetic programming algorithm, Pomorstvo 1332-0718, 34(2), 1-31, 2020, Hrvatska*
- *Baressi Šegota, S.; Lorencin, I.; Anđelić, N.; Mrzljak, V.; Car, Z., Improvement of Marine Steam Turbine Conventional Exergy Analysis by Neural Network Application, Journal of Marine Science and Engineering, 2077-1312, 8(11), 1-38, 2020, Švicarska*
- *Lorencin, I.; Baressi Šegota, S.; Anđelić, N.; Blagojević, A.; Šušteršič, T.; Protić, A.; Arsenijević, M.; Čabov, T.; Filipović, N.; Car, Z., Automatic Evaluation of the Lung Condition of COVID-19 Patients Using X-ray Images and Convolutional Neural Networks, Journal of Personalized Medicine, 2075-4426, 11(1), 1-28, 2021, Švicarska*
- *Anđelić, N.; Baressi Šegota, S.; Lorencin, I.; Mrzljak, V.; Car, Z., Estimation of COVID-19 epidemic curves using genetic programming algorithm, Health Informatics Journal, 1460-4582 27(1) sij.40, 2021, Ujedinjeno Kraljevstvo*

- *Anđelić, N.; Baressi Šegota, S.; Lorencin, I.; Jurilj, Z.; Šušteršič, T.; Blagojević, A.; Protić, A.; Čabov, T.; Filipović, N.; Car, Z., Estimation of covid-19 epidemiology curve of the united states using genetic programming algorithm, International Journal of Environmental Research and Public Health, 1660-4601, 18(3), 1-26, 2021, Švicarska*
- *Lorencin, I.; Baressi Šegota, S.; Anđelić, N.; Mrzljak, V.; Čabov, T.; Španjol, J.; Car, Z.; On Urinary Bladder Cancer Diagnosis: Utilization of Deep Convolutional Generative Adversarial Networks for Data Augmentation, Biology, 2079-7737, 10(3), 1-27, 2021, Švicarska*
- *Blagojević, A.; Šušteršič, T.; Lorencin, I.; Baressi Šegota, S.; Milovanović, D.; Baskić, D.; Baskić, D.; Car, Z.; Filipović, N., Combined machine learning and finite element simulation approach towards personalized model for prognosis of COVID-19 disease development in patients, AI Endorsed Transactions on Bioinformatics and Bioengineering, 2709-4111, 21(2), 1-10, 2021, Belgium*
- *Musulin, J.; Baressi Šegota, S.; Štifanić, D.; Lorencin, I.; Anđelić, N.; Šušteršič, T.; Blagojević, A.; Filipović, N.; Čabov, T.; Markova-Car, E., Application of Artificial Intelligence-Based Regression Methods in the Problem of COVID-19 Spread Prediction: A Systematic Review International Journal of Environmental Research and Public Health, 1660-4601, 18(8), 1-39, 2021, Švicarska*
- *Baressi Šegota, S.; Lorencin, I.; Anđelić, N.; Štifanić, D.; Musulin, J.; Vlahinić, S.; Šušteršič, T.; Blagojević, A.; Car, Z., Automated Pipeline for Continual Data Gathering and Retraining of the Machine Learning-Based COVID-19 Spread Models, EAI Endorsed Transactions on Bioinformatics and Bioengineering, 2709-4111, 21(3), 1-9, 2021, Belgium*
- *Anđelić, N.; Baressi Šegota, S.; Lorencin, I.; Poljak, I.; Mrzljak, V.; Car, Z., Use of Genetic Programming for the Estimation of CODLAG Propulsion System Parameters Journal of Marine Science and Engineering, 2077-1312, 9(6), 1-31, 2021, Švicarska*
- *Štifanić, D.; Musulin, J.; Jurilj, Z.; Baressi Šegota, S.; Lorencin, I.; Anđelić, N.; Vlahinić, S.; Šušteršič, T.; Blagojević, A.; Filipović, N., Semantic segmentation of chest X-ray images based on the severity of COVID-19 infected patients, EAI Endorsed Transactions on Bioinformatics and Bioengineering, 2709-4111, 21(3), 1-8, 2021, Belgium*
- *Baressi Šegota, S.; Anđelić, N.; Car, Z.; Šercer, M., Neural Network-Based Model for Classification of Faults During Operation of a Robotic Manipulator, Technical Gazette, 1330-3651, 28(4), 1380-1387, 2021, Hrvatska*
- *Baressi Šegota, S.; Anđelić, N.; Mrzljak, V.; Lorencin, I.; Kuric, I.; Car, Z., Utilization of multilayer perceptron for determining the inverse kinematics of an industrial robotic manipulator, International Journal of Advanced Robotic Systems, 1729-8814, 18(4), 1-11, 2021, Ujedinjeno Kraljevstvo*
- *Mrzljak, V.; Baressi Šegota, S.; Meštrić, H.; Car, Z., Comparison of Power Distribution, Losses and Efficiencies of a Steam Turbine with and without Extractions, Technical Journal, 1846-6168, 14(4), 480-487, 2020, Hrvatska*
- *Anđelić, N.; Mrzljak, V.; Lorencin, I.; Baressi Šegota, S., Comparison of Exergy and Various Energy Analysis Methods for a Main Marine Steam Turbine at Different Loads, Pomorski Zbornik, 0554-6397, 59(1), 9-34, 2021, Hrvatska*
- *Mrzljak, V.; Anđelić, N.; Lorencin, I.; Baressi Šegota, S., The influence of various optimization algorithms on nuclear power plant steam turbine exergy efficiency and destruction, Pomorstvo 1332-0718, 35(1), 69-86, 2021, Hrvatska*
- *Mrzljak, V.; Kudlaček, J.; Baressi Šegota, S.; Medica-Viola, V., Energy and Exergy Analysis of Waste Heat Recovery Closed-Cycle Gas Turbine System while Operating with Different Medium, Pomorski Zbornik, 0554-6397, 60(1), 21-48, 2021, Hrvatska*





- Musulin, J.; Štifanić, D.; Zuljani, A.; Čabov, T.; Dekanić, A.; Car, Z., An enhanced histopathology analysis: An ai-based system for multiclass grading of oral squamous cell carcinoma and segmenting of epithelial and stromal tissue, *Cancers*, 2072-6694, 13(8), sij.21, 2021, Švicarska
- Štifanić, D.; Musulin, J.; Car, Z.; Čep, R., Use of Convolutional Neural Network for Fish Species Classification, *Pomorski Zbornik*, 0554-6397, 59 (1), 131-142, 2021, Hrvatska
- Musulin, J.; Lorencin, I.; Meštrić, H.; Car, Z., Intelligent Automation System for Vessels Recognition: Comparison of SIFT and SURF Methods, *Technical Journal*, 1846-6168, 28 (4), 1221-1226, 2020, Hrvatska
- Mrzljak, V.; Lorencin, I.; Anđelić, N.; Car, Z., Thermodynamic Analysis of a Condensate Heating System from a Marine Steam Propulsion Plant with Steam Reheating, *Journal of Marine Science and Application*, 1993-5048 20, (1), 117-127, 2020, Njemačka

#### MEDUNARODNI KONGRESI | INTERNATIONAL CONGRESSES

- Šverko, Z.; Vlahinić, S.; Vrankić, M.; Markovinović, I., Delta/Alpha Ratio for Diagnosis of Autism Spectrum Disorder, *Proceedings of the 2020 43rd International Convention on Information, Communication and Electronic Technology (MIPRO)*, 158-162, 2020, Opatija, Hrvatska
- Cetkovic, D.; Vlahinic, S.; Frankovic, D.; Komen, V., Analysis of justification for using capacitor banks in distribution networks with low power demand, *Proceedings of the 2020 43rd International Convention on Information, Communication and Electronic Technology (MIPRO)*, 923-927, 2020, Opatija, Hrvatska
- Bogunović, N.; Vlahinić, S.; Franković, D.; Komen, V., Application of PandaPower Tool in Evaluating the Potential of Using PV Distributed Generation for Voltage Regulation in Electrical Power Networks, *Proceedings of the 2020 43rd International Convention on Information, Communication and Electronic Technology (MIPRO)*, 912-917, 2020, Opatija, Hrvatska
- Gradišnik, V., Analysis of a-Si:H p-i-n photodiode detection of HeLa cells luminescence, *MIPRO 2020 43rd International Convention September 28, 2020 – October 2, 2020 Opatija, Croatia, Proceedings*, ISSN 1847-3946, 2209-2213, 2020, Rijeka, Croatia
- Jurdana, V.; Volarić, I.; Sučić, V., A Sparse TFD Reconstruction Approach Using the S-method and Local Entropies Information, *12TH INT'L SYMPOSIUM ON IMAGE AND SIGNAL PROCESSING AND ANALYSIS (ISPA 2021)*, 2021, Zagreb, Hrvatska
- Šušteršič, T.; Blagojević, A.; Cvetković, D.; Cvetković, A.; Lorencin, I.; Baressi Šegota, S.; Car, Z.; Filipović, N.; Epidemiological Predictive Modelling of Covid-19 Spread, *8th International Congress of the Serbian Society of Mechanics* 978-86-909973, 8(1), 186-201, 2021, Kragujevac, Serbia
- Car, Z.; Baressi Šegota, S.; Anđelić, N.; Lorencin, I.; Musulin, J.; Štifanić, D.; Mrzljak, V.; Determining Inverse Kinematics of a Serial Robotic Manipulator Through the Use of Genetic Programming Algorithm, *8th International Congress of the Serbian Society of Mechanics* 978-86-909974, 8(1), 500-505, 2021, Kragujevac, Serbia
- Mrzljak, V.; Prpić-Oršić, J.; Poljak, I.; Baressi Šegota, S.; Efficiencies and losses comparison of three steam turbines—from conventional, nuclear and marine power plant, *Machines. Technologies. Materials.*, 1313-0226, 15(4), 44444, 2021, Borovets, Bulgaria
- Mrzljak, V.; Lorencin, I.; Anđelić, N.; Baressi Šegota, S.; Comparison of three methods for the pump energy analysis, *Mathematical Modeling*, 2535-0986, 4(3), 82-85, 2020, Borovets, Bulgaria
- Baressi Šegota, S.; Štifanić, D.; Musulin, J.; Car, Z., A Brief Note on the Influence of Storage Choices on Machine Learning Algorithm Training Times, *Ri-STEM-2021*, 978-953-8246-22-7, 1(1), 19-26, 2021, Rijeka, Croatia

- Baressi Šegota, S.; Anđelić, N.; Lorencin, I.; Štifanić, D.; Musulin, J.; Car, Z., Z4 HPC Cluster RI-STEM-2021, 978-953-8246-22-7, 1(1), 51-56, 2021, Rijeka, Croatia
- Mioč, A.; Fabulić, B.; Musulin, J.; Štifanić, D.; Markova-Car, E., Investigation of the association between polymorphisms in the circadian CLOCK and NPAS2 genes and cancer by using methods of AI, *Ri-STEM-2021*, 978-953-8246-22-7, 1(1), 91-94, 2021, Rijeka, Croatia
- Musulin, J.; Štifanić, D.; Zuljani, A.; Car, Z., Multiclass Classification of Oral Squamous Cell Carcinoma, *Ri-STEM-2021*, 978-953-8246-22-7, 1(1), 44537, 2021, Rijeka, Croatia
- Blagojević, A.; Šušteršič, T.; Lorencin, I.; Filipović, N., Use of Regressive Artificial Intelligence and Machine Learning Methods in Modelling of COVID-19 Spread (COVIDAi): Project Review, *Ri-STEM-2022*, 978-953-8246-22-8, 1(1), 44348, 2021, Rijeka, Croatia
- Štifanić, D.; Miočević, A.; Car, Z., Forecasting Stock Index Movement Using Stationary Wavelet Transform and Long Short-Term Memory network, *My First Conference*, 978-953-8246-18-0, 4(1), 34-35, 2020, Rijeka, Croatia
- Baressi Šegota, S.; Anđelić, N.; Mrzljak, V.; Car, Z., Fault Detection in Robotic Manipulators using Support Vector Machines, *My First Conference*, 978-953-8246-18-1, 4(1), 44289, 2020, Rijeka, Croatia
- Musulin, J.; Smolić, K.; Car, Z., Bladder Cancer Recognition Using SIFT and SURF Features My First Conference, 978-953-8246-18-2, 4(1), 24-25, 2020, Rijeka, Croatia
- Musulin, J.; Smolčić, K.; Štifanić, D.; Španjol, J.; Car, Z., Bladder cancer detection: Integration of feature extraction algorithms and MLP, *5th International Workshop on Data Science, Book of abstracts*, 5(1), 43-44, 2020, Rijeka, Croatia
- Štifanić, D.; Jukić, A.; Musulin, J.; Car, Z., Forecasting Dow Jones Industrial Average Index Movement Using Long Short-Term Memory network, *5th International Workshop on Data Science, Book of abstracts*, 5(1), 45-47, 2020, Zagreb, Croatia
- Baressi Šegota, S.; Anđelić, N.; Lorencin, I.; Mrzljak, V.; Car, Z., On the Application of Artificial Intelligence in the Problem of COVID-19 Spread Prediction, *5th International Workshop on Data Science, Book of abstracts*, 35-37, 2020, Zagreb, Croatia
- Mrzljak, V.; Prpić-Oršić, J.; Lorencin, I.; Anđelić, N., Exergy analysis of three cylinder steam turbine from supercritical coal-fired power plant, *trans&MOTAUTO '21*, 1313-5031, 4(8), 92-95, 2021, Varna, Bulgaria
- Mrzljak, V.; Prpić-Oršić, J.; Poljak, I.; Baressi Šegota, S., Efficiency and loss analysis of main steam condenser from nuclear power plant at various loads and ambient temperatures *INDUSTRY 4.0* 2535-0153, 1(11), 45-48, 2021, Borovets, Bulgaria
- Lysdahlgaard, S.; Baressi Šegota, S.; Antulov, R.; Hess, S.; Weber Kusk, M.; Car, Z., Validation of deep learning algorithms for quality assesment of lateral knee x-ray examinations, *"World Congress of International Society of Radiographers and Radiological Technologists"*, 978-1-909802-63-6, 21(1), 80-81, 2021, Dublin, Ireland

#### MEDUNARODNA SURADNJA | INTERNATIONAL COLLABORATIONS

- RMIT University, Melbourne, Australija, Australia
- University of Queensland, Brisbane, Australija, Australia
- Elektrotehnički fakultet, Univerzitet Crne Gore, Podgorica, Crna Gora, Montenegro
- University in Prague Faculty Mechanical Engineering University, Republika Češka, Czech Republic



- *Tomas Bata University in Zlin, Republika Češka, Czech Republic*
- *Technical University in Ostrava, Republika Češka, Czech Republic*
- *Vienna University of Technology, Austrija, Austria*
- *University in Miskolc, Mađarska, Hungary*
- *Budapest University of Technology and Economics, Mađarska, Hungary*
- *University of Žilina, Slovačka, Slovakia*
- *Poznan University of Technology, Poljska, Poland*
- *Kielce University of Technology, Poljska, Poland*
- *University of Ljubljana, Slovenija, Slovenia*
- *University of Novi Sad, Srbija, Serbia*
- *North University of Baia Mare, Rumunjska, Romania*
- *University of Kragujevac, Srbija, Serbia*
- *Danieli Automation, Italija, Italy*
- *Texas Instruments, SAD USA*
- *Linz Center of Mechatronics GmbH, Austrija, Austria*
- *Johannes Kepler Universität Linz, Austrija, Austria*
- *Hiroshima University, Japan, Japan*
- *The International Science And Technology Conference Institute - ISTCI, Kina, China*



5<sup>2</sup>

**ZAVOD ZA BRODOGRADNJU I  
INŽENJERSTVO MORSKE TEHNOLOGIJE**  
DEPARTMENT OF NAVAL ARCHITECTURE AND  
OCEAN ENGINEERING





## DJELATNICI FACULTY AND STAFF

### PREDSTOJNIK ZAVODA | DEPARTMENT HEAD:



Prof. dr. sc. / Prof. D. Sc. **Roko Dejhalla**

*otpor i propulzija plovnih objekata; brodski propulzori; gradnja i održavanje malih plovnih objekata; projektiranje malih plovnih objekata; osnivanje broda*  
ship resistance and propulsion; ship propulsion devices; small craft building and maintenance; small craft design; ship design

### REDOVITI PROFESORI U TRAJNOM ZVANJU | TENURED PROFESSORS



**Jasna Prpić-Oršić**

*pomorstvenost; njihanje i opterećenje plovnih objekata na morskim valovima; modeliranje okoliša i okolišnih opterećenja; dinamika pomorskih objekata*  
seakeeping; motions and sea loads of ships and off-shore structures; modeling of environment and environmental loads; marine structures dynamics

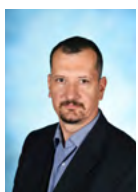

**Albert Zamarin**

*konstrukcija broda; čvrstoća broda; strukturalna analiza broda; opterećenje plovnih objekata na morskim valovima; projektiranje strukture plovnih objekata; konstrukcija malih plovnih objekata*  
ship structure; ship strength; ship structural analysis; ship structural design; sea loads of ships and off-shore structures; small craft construction

### IZVANREDNI PROFESORI | ASSOCIATE PROFESSORS



**Marko Hadjina**

*metodologija gradnje i opremanja plovnih objekata; tehnologija i organizacija brodogradnje; projektiranje tehnologije gradnje broda; računalno integrirana gradnja broda; simulacijsko modeliranje brodograđevnih procesa; osnivanje brodogradilišta i proizvodnih procesa; ugovaranje plovnih objekata*  
ship production methodology and outfitting; shipbuilding technology and organisation; ship construction technology design; computer integrated ship construction; shipyards' production processes simulation modelling; shipyard and production process design; market analysis; ship contracting

**Tin Matulja**



*gradnja i opremanje plovnih objekata; tehnologija i organizacija brodogradnje; osnivanje brodogradilišta i proizvodnih procesa; oprema plovnih objekata*  
ship production and outfitting; shipbuilding technology and organisation; shipyard and production process design; floating objects equipment and outfitting;

### DOCENTI | ASSISTANT PROFESSORS

**Dunja Legović**



*otpor i propulzija plovnih objekata; dinamika broda; brodski propulzori; pomorstvenost plovnih objekata; brodske forme; zaštita okoliša*  
ship resistance and propulsion; ship dynamics; ship propulsion devices; seakeeping; ship hull forms; environment protection;

**Anton Turk**



*plovnost i stabilitet broda; brodske forme; hidrostatika broda; stabilitet broda u eksploataciji*  
seaworthiness and stability; ship hull forms; ship hydrostatics; ship stability in exploitation

**Marko Valčić**



*dinamika i pomorstvenost plovnih objekata; objekti morske tehnologije; odobalne operacije; vođenje i upravljanje plovnim objektima; dinamičko pozicioniranje; autonomna navigacija*  
ship dynamics and seakeeping; ocean mobile and fixed structures; offshore operations; guidance and control of marine vehicles; dynamic positioning; autonomous navigation

### ASISTENTI | ASSISTANTS

**Davor Bolf**



*konstrukcija broda; čvrstoća broda; strukturalna analiza broda; konstrukcija malih plovnih objekata; kompozitni materijali u brodskim strukturama*  
ship structure; ship strength; ship structural analysis; small craft construction; composite materials in ship structures

**Ivan Sulovsky**



*pomorstvenost plovnih objekata; objekti morske tehnologije; odobalne operacije; njihanje i opterećenje plovnih objekata na morskim valovima*  
seakeeping; ocean mobile and fixed objects; offshore operations; motions and sea loads of ships and off-shore structures

### STRUČNI SURADNICI | ASSOCIATES

**Darin Majnarić**



*strukturalna analiza broda*  
ship structural analysis



**Lino Josip Novak**

*računarska dinamika fluida  
computational fluid dynamics*



**Sara Volarić**

*EU projekti - administratorica  
EU projects - administrator*

**VANJSKI SURADNICI | ASSOCIATES**

**Mirela Marin**

Brodogradilište Viktor Lenac | Shipyard Viktor Lenac  
*osnivanje plovniha objekata  
ship design*

**Ivan Margić**

School of Fish d.o.o.  
*osnivanje plovniha objekata  
ship design*

**Alan Klanac**

as2con - Alveus d.o.o., Rijeka  
*strukturna analiza broda  
ship structural analysis*

**Branko Radil**

Hrvatski registar brodova | Croatian Register of Shipping  
*konstrukcija broda  
ship structures*

**Rajko Rubeša**

Brodogradilište "3.MAJ" | Shipyard "3.MAJ"  
*tehnološki proces gradnje i opremanja broda;  
upravljanje projektima u brodogradnji  
ship construction and outfitting technological process;  
project management in shipbuilding*

*Lectures in the field of: marine vessel design, technology and organization of shipbuilding, marine vessel construction, marine hydromechanics.*

*Program of lifelong learning for admission to the graduate university study of naval architecture.*

**NASTAVA I ZNANOST  
EDUCATION AND SCIENCE**

*Nastava iz područja: projektiranje plovniha objekata, tehnologija i organizacija brodogradnje, konstrukcija plovniha objekata, hidromehanika plovniha objekata.*

*Program razlikovne edukacije za upis na diplomski sveučilišni studij brodogradnje.*

**KOLEGIJI NA PREDDIPLOMSKIM SVEUČILIŠNIM STUDIJIMA**

| UNDERGRADUATE UNIVERSITY COURSES

- Brodske forme
- Gradnja i održavanje malih plovniha objekata SV
- Hidrodinamika plovniha objekata I
- Konstrukcija broda I
- Konstrukcija broda II
- Oprema broda
- Osnove dinamike broda
- Osnove gradnje broda
- Plovnost i stabilitet broda
- Stručna praksa I
- Tehnologija brodogradnje
- Ship Hull Forms
- Small Craft Building and Maintenance UN
- Marine Hydrodynamics I
- Ship Structure I
- Ship Structure II
- Ship Equipment
- Basic Ship Dynamics
- Basics of Ship Production
- Seaworthiness and Stability of the Ship
- Industrial practice I
- Shipbuilding Technology

- Tehnološki procesi brodogradnje
- Uvod u plovne objekte
- Uvod u vođenje i upravljanje plovniha objektima
- Zaštita okoliša

- Technology Processes of Shipbuilding
- Introduction to Marine Vessels
- Introduction to guidance and control of marine vehicles
- Environmental protection

**KOLEGIJI NA DIPLOMSKIM SVEUČILIŠNIM STUDIJIMA**

| GRADUATE UNIVERSITY COURSES

- Brodski propulzori
- Osnivanje brodogradilišta
- Čvrstoća broda
- Dinamika pomorskih konstrukcija
- Hidrodinamika plovniha objekata II
- Konstrukcija malih plovniha objekata
- Metodologija gradnje plovniha objekata
- Objekti morske tehnologije
- Odobalne operacije
- Oprema malih plovniha objekata
- Opremanje i remont broda
- Organizacija i poslovanje brodogradilišta
- Osnivanje plovniha objekata I
- Osnivanje plovniha objekata II
- Pomorstvenost plovniha objekata
- Projektiranje malih plovniha objekata
- Stabilitet broda u eksploataciji
- Stručna praksa II
- Strukturna analiza broda
- Tehnološki proces gradnje broda
- Ugovaranje plovniha objekata
- Upravljanje projektima u brodogradnji
- Ship Propulsion Devices
- Shipyard Design
- Ship Strength
- Dynamics of Off Shore Structures
- Marine Hydrodynamics II
- Small Craft Construction
- Methodology of Ship Production
- Offshore structures and vehicles
- Offshore operations
- Small Crafts Equipment
- Ship Outfitting and Repair
- Shipyards Organisation and Management
- Ship Design I
- Ship Design II
- Seakeeping
- Small Craft Design
- Ship Stability in Exploitation
- Industrial practice II
- Ship Structural Analysis
- Technological Process of Shipbuilding
- Ship Negotiation Process
- Project Management in Shipbuilding

**KOLEGIJI NA PREDDIPLOMSKIM STRUČNIM STUDIJIMA**

| UNDERGRADUATE VOCATIONAL COURSES

- Brodske forme ST
- Gradnja i održavanje malih plovniha objekata
- Hidrostatika broda
- Konstrukcija broda
- Oprema broda ST
- Osnivanje plovniha objekata
- Plovni objekti
- Stručna praksa I
- Stručna praksa II
- Strukturni elementi broda
- Tehnologija brodogradnje I
- Tehnologija brodogradnje II
- Tehnološki procesi gradnje i remonta broda
- Ship Hull Forms VO
- Small Craft Building and Maintenance
- Ship Hydrostatics
- Ship Construction
- Ship Equipment ST
- Ship Design
- Marine Vessels
- Professional practice I
- Professional practice II
- Ship Structure
- Shipbuilding Technology I
- Shipbuilding Technology II
- Technological Processes of Shipbuilding and Repair

**KOLEGIJI NA POSLIJEDIPLOMSKIM (DOKTORSKIM) SVEUČILIŠNIM STUDIJIMA**

| POSTGRADUATE UNIVERSITY (DOCTORAL) COURSES

- Integralna tehnologija gradnje broda
- Izabrana poglavlja iz metodologije gradnje plovniha objekata
- Metodologija projektiranja plovniha objekata
- Izabrana poglavlja iz osnivanja plovniha objekata
- Pomorstvenost i upravljivost plovniha objekata
- Izabrana poglavlja iz dinamike plovniha objekata
- Integrated Ship Production Technology
- Selected Topics in Floating Objects Production Methodology
- Methodology of Ship Design
- Selected Topics in Ship Design
- Seakeeping and Manoeuvrability
- Selected Topics in Marine Dynamics



- Izabrana poglavlja iz otpora plovnih objekata
- Izabrana poglavlja iz propulzije plovnih objekata
- Projektiranje strukture plovnih objekata
- Opremanje plovni i pučinskih objekata
- Selected Topics in Ship Resistance
- Selected Topics in Ship Propulsion
- Ship Structural Design
- Outfitting of marine vessels and offshore structures

## ZNANSTVENOISTRAŽIVAČKI RAD | SCIENTIFIC RESEARCH

- hidrodinamičko opterećenje i odziv pomorskih objekata na morskim valovima  
hydrodynamic loads and response of marine objects
- projektiranje strukture broda, nove tehnologije kod projektiranja i preinaka brodskih konstrukcija, tehnološkičnost kod projektiranja i izrade brodskih konstrukcija  
ship structural design, new technologies in ship structural design and conversions, technologicality in ship structure design and construction
- otpor i propulzija plovnih objekata, hidrodinamičke optimizacije  
ship resistance and propulsion, hydrodynamic optimizations
- primjena naprednih tehnologija i metoda gradnje i opremanja plovnih objekata; organizacija brodograđevnog poslovnog i proizvodnog procesa; osnivanje i unapređenje brodograđilišta i proizvodnih procesa, primjena simulacijskog modeliranja, višekriterijskog odlučivanja i LEAN metodologije za unapređenje brodograđevnog procesa, analiza tržišta; ugovaranje i tehnološko prognoziranje  
application of advanced technology and methods in ship construction and outfitting; organization of shipbuilding business and production process, the establishment and improvement of the shipyards and manufacturing processes, the application of simulation modeling, multicriteria decision making and LEAN methodologies to improve the shipbuilding process, market analysis, contracting and technological forecasting
- primjena kompozitnih materijala na pomorskim konstrukcijama, analiza sudara malih kompozitnih plovila  
application of composite materials on marine structures, Small composites crafts collision analysis
- utjecaj opterećenja okoliša na značajke sustava dinamičkog pozicioniranja plovnih objekata  
the impact of environmental loads on the characteristics of dynamic positioning systems for marine vessels

## PROJEKTI | PROJECTS

- Nesigurnosti procjene brzine broda u pri realnim vremenskim uvjetima, uniri-tehnic-18-18 1146, Sveučilište u Rijeci, Jasna Prpić-Oršić, 2018. -, znanstvenoistraživački  
Uncertainties of ship speed loss evaluation under real weather conditions, uniri-tehnic-18-18 1146, University of Rijeka, Jasna Prpić-Oršić, 2018.-, research and scientific project
- Sustav potpore odlučivanju za zeleniju i sigurniju plovidbu brodova (DESSERT) IP-2018-01-3739, Hrvatska zaklada za znanost, Jasna Prpić-Oršić, 2018-2022, znanstvenoistraživački  
DEcision Support System for green and safe ship Routing (DESSERT) IP-2018-01-3739, Croatian Science Foundation, Jasna Prpić-Oršić, 2018-2022
- Utjecaj opterećenja okoliša na značajke sustava dinamičkog pozicioniranja plovnih objekata. Šifra projekta: uniri-tehnic-18-266. Financiranje: Sveučilište u Rijeci. Voditelj: Marko Valčić. Trajanje: 2018.-2021. Vrsta projekta: znanstveno-istraživački projekt.  
The impact of environmental loads on the characteristics of dynamic positioning systems for marine vessels. Project ID: uniri-tehnic-18-266. Funding: University of Rijeka. Head: Marko Valčić. Period: 2018-2021. Project type: research project.

- Unapređenje metodologije projektiranja i gradnje broda prema konceptu Industrija 4.0; Potpora znanstvenim istraživanjima za 2018. g. Sveučilišta u Rijeci, Voditelj istraživačkog tima: prof. dr. sc. Albert Zamarin, dipl. ing., 2018.-2021.  
Development of Methodology for Ship Design and Production towards Industry 4.0. Concept; Support for scientific research in 2018., University of Rijeka, Head of the research team: prof. dr. sc. Albert Zamarin, 2018.-2021.
- Maritime Environment-friendly TRanspOrt systems (METRO), 2014 - 2020 Interreg V-A Italy - Croatia CBC Programme, razdoblje: 01.01.2019.- 31.12.2021., voditelj (Tehnički fakultet u Rijeci): prof. dr. sc. Roko Dejhalla  
Maritime Environment-friendly TRanspOrt systems (METRO), 2014 - 2020 Interreg V-A Italy - Croatia CBC Programme, period: January 1, 2019.- December 31, 2021, head (Faculty of Engineering): prof. Roko Dejhalla
- NEREAS - Numerička rekonstrukcija u arheologiji pomorstva, Hrvatska zaklada za znanost, 2020-2024, Nositelj: UNIZD Odjel za arheologiju, voditelj prof.dr.sc. Irena Radić Rossi, znanstvenoistraživački, Partner UNIRI RITEH, prof.dr.sc. Albert Zamarin, asist. Davor Bolf  
Numerical Reconstruction in the Archaeology of Seafaring, HRZZ, 2020-2024, UNIZD Irena Radić Rossi

## PUBLIKACIJE | PUBLICATIONS

## RADovi U ČASOPISIMA | JOURNAL PAPERS

- Chen, C.; Sasa, K.; Prpić-Oršić, J.; Mizojiri, T., A statistical approach to wave effects on ship navigation using high-resolution numerical wave simulation and shipboard measurements  
Ocean Engineering, ISSN 0029-8018, 229, 2021, Oxford, United Kingdom, USA
- Braidotti, L.; Valčić, M.; Prpić-Oršić, J., Exploring a Flooding-Sensors-Agnostic Prediction of the Damage Consequences Based on Machine Learning, Journal of Marine Science and Engineering, 2077-1312, 9 (3), 271, 20, 2021, Basel, Switzerland
- Pelić, V.; Mrakovčić, T.; Radonja, R.; Valčić, M., Analysis of the Impact of Split Injection on Fuel Consumption and NOx Emissions of Marine Medium-Speed Diesel Engine, Journal of Marine Science and Engineering, 2077-1312, 8 (10), 820, 23, 2020, Basel, Switzerland
- Pelić, V.; Mrakovčić, T.; Medica-Viola, V.; Valčić, M., Effect of Early Closing of the Inlet Valve on Fuel Consumption and Temperature in a Medium Speed Marine Diesel Engine Cylinder  
Journal of Marine Science and Engineering, 2077-1312, 8 (10), 747, 18, 2020, Basel, Switzerland
- Kučić, M.; Valčić, M., Stereo Visual Odometry for Indoor Localization of Ship Model, Pomorski zbornik: Journal of Maritime and Transportation Sciences, 0554-6397, 58 (1), 57-75, 2020, Rijeka, Hrvatska
- Pelić, V.; Mrakovčić, T.; Bukovac, O.; Valčić, M., Development and Validation of 4 Stroke Marine Diesel Engine, Pomorski zbornik: Journal of Maritime and Transportation Sciences, 0554-6397, Special Edition, 359-372, 2020, Rijeka, Hrvatska
- Gaiotti, M, Zamarin, Josefson, L.; Matulja, T., A Numerical Sensitivity Analysis on the Cohesive Parameters of a Carbon-Steel Single Lap Joint  
Ocean Engineering ISSN 0029-8018, 198, 2020, Oxford, United Kingdom, USA
- Rubeša, R.; Matulja, T.; Hadjina, M.; Fafandjel, N., New Approach for Ship Drawing Planning Based on Their Reliability  
Journal of Ship Production and Design, ISSN 2158-2866, 36(4), 280-290, 2020, SNAME, USA



## MEĐUNARODNI KONGRESI | INTERNATIONAL CONGRESSES

- Braidotti, L.; Prpić-Oršić, J.; Valčić, M., *Application of decision trees to predict damage onsequences during the progressive flooding MARSTRUCT 2021 Conference, 2021, Trondheim, Norveška*
- Braidotti, L.; Prpić-Oršić, J.; Valčić, M.; Mauro, F.; Bucci, V., *The ship safety from seafarers perspective: application of fuzzy AHP for decision support, 14th Annual RIN Baška GNSS Conference - Workshop on Smart Blue and Green Maritime Technologies, 2021, Baška, Hrvatska*
- Mauro, F.; Nabergoj, R.; Prpić-Oršić, J., *Effect of optimal thruster location on DP operability of an offshore vessel MARTECH 2020, 2020, Lisabon, Portugal*
- Sasa, K.; Uchiyama, R.; Chen, C.; Terada, D.; Prpić-Oršić, J., *Multiple Evaluations of Speed Loss in Rough Sea Voyages for 28,000DWT Bulk Carrier, MARTECH 2020, 2020, Lisabon, Portugal*
- Dell'Acqua, A.; Braidotti, L.; Mauro, F.; Prpić-Oršić, J., *Two solutions for vertical motions assessment during concept design, 14th Annual RIN Baška GNSS Conference - Workshop on Smart Blue and Green Maritime Technologies, 2021, Baška, Hrvatska*
- Pelić, V.; Mrakovčić, T.; Medica-Viola, V.; Valčić, M., *Reducing Environmental Impact and Fuel Costs by Installing a Photovoltaic Power Plant On Board Book of Proceedings of the 24th Symposium on Theory and Practice of Shipbuilding, In Memoriam of prof. Leopold Sorta, 978-953-8246-20-3, 389-402, 2020, Rijeka, Hrvatska*
- Valčić, M.; Prpić-Oršić, J.; Čarija, Z., *An Artificial Neural Network Approach to Wind Loads Estimation, Book of Proceedings of the 24th Symposium on Theory and Practice of Shipbuilding, In Memoriam of prof. Leopold Sorta, 978-953-8246-20-3, 143-153, 2020, Rijeka, Hrvatska*
- Legović, D.; Vojnić, D., *Advantages and Challenges of Additive Manufacturing in Maritime Industry, Book of Proceedings of the 24th Symposium on Theory and Practice of Shipbuilding, In Memoriam of prof. Leopold Sorta, 978-953-8246-20-3, 539-548, 2020, Rijeka, Hrvatska*
- Majnarić, D.; Novak, L.J.; Dejhalla, R., *An Overview of Measures for Improving the Energy Performance of Ships, Book of Proceedings of the 24th Symposium on Theory and Practice of Shipbuilding, In Memoriam of prof. Leopold Sorta, 978-953-8246-20-3, 116-126, 2020, Rijeka, Hrvatska*
- Smilović M.; Turk, A.; Duletić, T.; Vuković A., *Centre of gravity envelope effect on intact and damage stability for high speed crafts, Book of proceedings 24. simpozija Teorija i praksa brodogradnje, in memoriam prof. Leopold Sorta (Sorta 2020)., 978-953-8246-20-3, 127-144, 2020, Rijeka, Hrvatska*
- Bolf, D.; Hadjina, M.; Zamarin, A.; Matulja, T., *Methodology of Integrated Design of the Ship Structure and Production Using the 3D Experience Platform, Book of proceedings 24. simpozija Teorija i praksa brodogradnje, in memoriam prof. Leopold Sorta (Sorta 2020). 978-953-8246-20-3, 335-342, 2020, Rijeka, Hrvatska*

## MEĐUNARODNA SURADNJA | INTERNATIONAL COLLABORATIONS

- AALTO University School of Engineering, Helsinki, Finska, Finland
- Norwegian University of Science and Technology, Center of Ships and Ocean Structures, Norwegian Center of Excellence, Trondheim, Norveška, Norway
- Technical University of Lisbon, Instituto Superior Tecnico, Lisabon, Portugal, Portugal
- University of Trieste, Department of Naval Architecture and Ocean Engineering, Trieste, Italija Italy
- University of Washington, Department of Industrial and Systems Engineering, Seattle, SAD, USA

- University of Naples, Naples, Italija, Italy
- University of Kobe, Japan, Japan
- University of Ljubljana, Faculty of Maritime Studies and Transport, Portorož, Slovenija, Slovenia
- Chalmers University of Technology, Švedska, Sweden



5<sup>3</sup>

ZAVOD ZA ELEKTROENERGETIKU  
DEPARTMENT OF  
ELECTRIC POWER SYSTEMS





## DJELATNICI FACULTY AND STAFF

### PREDSTOJNIK ZAVODA | DEPARTMENT HEAD:



Izv. prof. dr. sc. / Assoc. Prof. D. Sc. **Dubravko Franković**  
vođenje elektroenergetskog sustava; elektrane; projektiranje električnih postrojenja; obnovljivi izvori energije  
electric power systems control; power plants; power installations design; renewable energy sources

### REDOVITI PROFESOR | PROFESSOR



**Alfredo Višković**  
elektroenergetski sustavi; tržište električne energije; razvoj energetske projekata  
electric power systems; electricity markets; power generation project development

### IZVANREDNI PROFESOR | ASSOCIATE PROFESSOR



**Saša Sladić**  
energetska elektronika; elektromotorni pogoni; mehatronika; nove tehnologije i obnovljivi izvori energije  
power electronic; electric drives; mechatronics  
new technologies and renewable energy sources

### DOCENTI | ASSISTANT PROFESSORS



**Vedran Kirinčić**  
nadzor, zaštita i vođenje elektroenergetskog sustava; napredne mreže; električna postrojenja; održiva mobilnost  
power system monitoring; protection and control; smart grids; electric facilities, sustainable mobility



**Rene Prenc**  
elektroenergetski sustavi; projektiranje; distribuirani izvori  
electric power systems; electrical design; distributed generation

### VIŠI PREDAVAČI | SENIOR LECTURERS

#### Branka Dobraš

nadzor i vođenje elektroenergetskog sustava; modeliranje procesnih informacija; objektno orijentirano modeliranje  
electric power system control; process information modelling; object oriented modeling



#### Marijana Živić-Đurović

kvaliteta električne energije; pouzdanost; mikromreže  
quality of electricity supply; reliability; microgrids



### POSLIJEDOKTORAND | POSTDOCTORAL RESEARCH ASSISTANT

#### Vladimir Franki

elektroenergetski sustavi; tržište električne energije; razvoj energetske projekata  
electric power systems; electrical engineering fundamentals

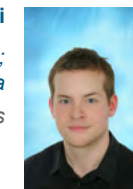

### ASISTENTI | ASSISTANTS

#### Alen Jakoplić

elektroenergetski sustavi; projektiranje; elektrane  
electric power systems; power plants; electrical design; renewable energy sources; photovoltaic systems



#### Petra Miletić

upravljanje elektromotornim pogonima; automatizacija  
control of electrical drives; automation



#### Michelle Rojnić

elektroenergetski sustavi; električni strojevi  
electric power systems; electrical machines





## VANJSKI SURADNICI | ASSOCIATES

Dino Mađar HOPS | HEP TSO  
 Vitomir Komen HEP ODS | HEP DSO  
 Vladimir Valentić HEP OPS | HEP TSO  
 Tomislav Plavšić HEP OPS | HEP TSO

Goran Klobučar  
 Srednja škola za elektrotehniku i računalstvo  
 | High School of Electrical Engineering and Computing

Ranko Lončarić  
 Hrvatski telekom d.d.  
 | Hrvatski telekom dd

## NASTAVA I ZNANOST

### EDUCATION AND SCIENCE

Nastava se izvodi iz područja osnova elektrotehnike, elektroenergetike i elektrostrojarstva.

CO: Elektroenergetika

Lectures in the field of electrical engineering fundamentals, power engineering and electrical machines and drives.

LLL: Power Systems

## KOLEGIJI NA PREDDIPLOMSKIM SVEUČILIŠNIM STUDIJIMA

| UNDERGRADUATE UNIVERSITY COURSES

- Električna postrojenja
- Električni strojevi
- Elektroenergetske mreže
- Elektromotorni pogoni
- Elektrotehnika R
- Energetska elektronika
- Modeliranje procesnih informacijskih sustava
- Osnove elektrotehnike I
- Osnove elektrotehnike II
- Electric Facilities
- Electrical Machines
- Electric Power Networks
- Electrical Drives
- Electrical Engineering R
- Power Electronics
- Modeling of Process Informatics in Power System
- Fundamentals of Electrical Engineering I
- Fundamentals of Electrical Engineering II

## KOLEGIJI NA PREDDIPLOMSKIM STRUČNIM STUDIJIMA

| UNDERGRADUATE VOCATIONAL COURSES

- Električne energetske mreže
- Elektroenergetska postrojenja
- Elementi elektroenergetskih postrojenja
- Izgradnja i održavanje elektroenergetskih postrojenja
- Osnove električnih strojeva
- Osnove elektrotehnike
- Osnove elektrotehnike ST I
- Osnove elektrotehnike ST II
- Osnove energetske elektronike
- Osnove projektiranja elektroenergetskih postrojenja
- Stručna praksa I
- Stručna praksa II
- Zaštita električnih postrojenja
- Electrical Power Networks
- Electric Power Plants
- Electrical Power Facilities Equipment
- Construction and Maintenance of Power Plants
- Fundamentals of Electrical Machines
- Fundamentals of Electrical Engineering
- Fundamentals of Electrical Engineering ST I
- Fundamentals of Electrical Engineering ST II
- Fundamentals of Power Electronics
- Fundamentals of Electric Power Facilities Design
- Professional practice I
- Professional practice II
- Power System Protection

## KOLEGIJI NA DIPLOMSKIM SVEUČILIŠNIM STUDIJIMA

| GRADUATE UNIVERSITY COURSES

- Brodska elektrotehnika
- Elektrane
- Elektroenergetski sustavi
- Modeliranje procesne informatike električnih postrojenja
- Ships Electrical Engineering
- Power Plants
- Electric Power Systems
- Modeling of Process Informatics in Power System

- Numerička analiza u elektromagnetizmu
- Prijenos i distribucija električne energije
- Projektiranje električnih postrojenja
- Elektromagnetizam
- Vođenje elektroenergetskog sustava
- Zaštita i automatika električnih postrojenja
- Urbani energetske sustavi
- Tehnika visokog napona
- Tržište električne energije
- Numerical Analysis in Electromagnetism
- Transmission and Distribution of Electrical Energy
- Electric Power Substation Design
- Electromagnetics
- Power System Control
- Protection and Automation of Electrical Installations
- Urban Energy Systems
- High Voltage Engineering
- Electricity Market

## KOLEGIJI NA POSLIJEDIPLOMSKIM (DOKTORSKIM) SVEUČILIŠNIM STUDIJIMA

| POSTGRADUATE UNIVERSITY (DOCTORAL) COURSES

- Energetska efikasnost u elektroenergetici
- Modeliranje sustava za distribuciju i potrošnju električne energije
- Aktivne distribucijske mreže
- Inteligentni elektroenergetski sustavi – Smart Grids
- Izabrana poglavlja iz energetske komponenti i sustava obnovljivih izvora energije
- Elementi energetske tranzicije
- Optimiranje u elektroenergetskom sustavu
- Energy efficiency in electrical systems
- Modeling of Electrical Power Distribution Systems
- Active Distribution Networks
- Intelligent Power Systems - Smart Grids
- Selected Chapters on Energy Components and Systems of Renewable Energy Sources
- The elements of energy transition
- Power system optimization

## ZNANSTVENOISTRAŽIVAČKI RAD | SCIENTIFIC RESEARCH

- Automatsko vođenje elektroenergetskog sustava; Napredne mreže; Mikromreže; Modeliranje elektroenergetskog sustava u stvarnom vremenu; Nadzor, zaštita i upravljanje elektroenergetskog sustava u stvarnom vremenu; Sinkronizirana mjerenja
- System Integrity protection Scheme; Smart Transmission Grid; Microgrids; Power System Modelling in Real Time; Wide Area Monitoring, Protection and Control of the Power System in Real Time; Synchronized Measurement
- Estimacija stanja elektroenergetskog sustava; Nadzor, zaštita i upravljanje elektroenergetskog sustava u realnom vremenu; Tehnologija sinkroniziranih mjerenja fazora
- Power System State Estimation; Wide Area Monitoring, Protection and Control of the Power System in Real Time; Synchronized Measurement Technology
- Razvoj suvremenih učinkovitih DC/DC i DC/AC pretvarača
- Design of modern power DC/DC and DC/AC converters
- Obnovljivi izvori energije, Fotonaponski sustavi, Napredne mreže
- Renewable energy systems, Photovoltaic systems, Smart grid

## PUBLIKACIJE | PUBLICATIONS

## RADOVI U ČASOPISIMA | JOURNAL PAPERS

- Bulat, H.; Franković, D.; Vlahinić, S., Enhanced Contingency Analysis—A Power System Operator Tool Energies, 1996-1073, 14, 2021
- Jakoplić, A.; Franković, D.; Kirinčić, V.; Plavšić, T., Benefits of short-term photovoltaic power production forecasting to the power system, Optimization and Engineering, 1389-4420, 22, 9-27, 2021
- Vlahinić, S.; Franković, D.; Juriša, B.; Zbunjak, Z., Back up protection scheme for high impedance faults detection in transmission systems based on synchrophasor measurements, IEEE Transactions on smart grid, 1949-3053, 12, 1736-1746, 2021



- Vlahinić, S.; Franković, D.; Đurović, M. Ž., Stojković, N., *Measurement uncertainty evaluation of transmission line parameters, IEEE Transactions on Instrumentation and Measurement, 0018-9456, 70, 1-7, 2021*
- Franki, V.; Višković, A.; Pavlović, D., *Emisije stakleničkih plinova elektroenergetskog sektora Jugoistočne Europe, Nafta i Plin, 1330-2434, 40, 33-41, 2020, Zagreb*
- Franki, V.; Višković, A.; Valentić, V., *Dynamic Stability Enhancement Through the Application of Stabilizers of Electromechanical Oscillations, Journal of Energy, 1849-0751, 70, 14-21, 2021*

**MEDUNARODNA SURADNJA** | INTERNATIONAL COLLABORATIONS

- KIOS Research Center for Intelligent Systems and Networks, Cipar, Cyprus
- University of Cyprus, Electrical and Computer Engineering Department, Cipar, Cyprus
- The University of Manchester, The School of Electrical and Electronic Engineering, Velika Britanija, United Kingdom



# 5.4

## ZAVOD ZA INDUSTRIJSKO INŽENJERSTVO I MENADŽMENT

DEPARTMENT OF INDUSTRIAL ENGINEERING  
AND MANAGEMENT





## DJELATNICI FACULTY AND STAFF

### PREDSTOJNIK ZAVODA | DEPARTMENT HEAD:



Prof. dr. sc. / Prof. D. Sc. **Zoran Jurković**

*alatni strojevi i oprema; CAD/CAM/CAE; dizajn alata i naprava; modeliranje, simulacija i optimizacija procesa obrade; planiranje eksperimenta*

*machine tools & equipment; CAD/CAM/CAE; design of tools and fixtures; modeling, simulation and optimization of machining processes; design of experiments*

### REDOVITI PROFESORI U TRAJNOM ZVANJU | TENURED PROFESSORS



**Goran Cukor**

*napredni obradni sustavi i tehnologije; modeliranje i optimiranje obradnih procesa*

*advanced manufacturing systems and technology; modelling and optimisation of machining processes*



**Milan Ikonić**

*proizvodno strojarstvo; projektiranje proizvodnih sustava; CIM; planiranje i upravljanje proizvodnjom; proizvodni management; projektni management; organizacija i ekonomika poslovnih sustava*

*production engineering; designing of manufacturing systems; CIM; production planning and control; production management; project management; organization of manufacturing and business systems*



**Duško Pavletić**

*upravljanje kvalitetom; osiguranje i nadzor kvalitete; sustavi kvalitete; zavarivačko inženjerstvo; spajanje materijala; mjeriteljstvo; mjerenje i kontrola kvalitete*

*quality management; quality assurance and control; quality systems; welding engineering; joining of materials; metrology; measurements and quality control*



**Mladen Perinić**

*projektiranje tehnoloških procesa; CAM, CAP, CAD/NC-CIM; modeliranje, simulacija i optimizacija tehnoloških procesa*

*process planning; CAM, CAP, CAD/NC-CIM; modeling, simulation and processes plans optimization*

### DOCENTI | ASSISTANT PROFESSORS

**Sandro Doboviček**

*organizacija proizvodnje; proizvodni management; projektiranje proizvodnih sustava  
operations and process management;  
manufacturing system design*



**Graciela Šterpin Valić**

*napredni proizvodni sustavi i tehnologije; alatni strojevi i oprema; modeliranje i optimiranje obradnih procesa  
advanced manufacturing systems and technology; machine tools and equipment; modeling and optimization of machining processes*



**Samir Žic**

*planiranje i upravljanje proizvodnjom; organizacija i ekonomika poslovnih sustava; management i organizacijski razvoj  
production planning and control; organization and economics of business systems; management and organizational development*



### ASISTENTI | ASSISTANTS

**David Ištoković**

*projektiranje tehnoloških procesa; CAM, CAP, CAD/NC-CIM; modeliranje, simulacija i optimizacija tehnoloških procesa  
process planning; CAM, CAP, CAD/NC-CIM; modeling, simulation and processes plans optimization*



**Maja Vlatković**

*upravljanje kvalitetom; osiguranje i nadzor kvalitete; mjerenje i kontrola kvalitete  
quality management; quality assurance and control; measurements and quality control*



### PROFESOR EMERITUS | PROFESSOR EMERITUS

**Elsó Kuljanić**  
Akademik HAZU  
HAZU academician



## STRUČNI SURADNIK | ASSOCIATE



Ivana Čabrijan

rad na projektu; eksperimentalna ispitivanja  
work on the project; experimental research

## VANJSKI SURADNICI | ASSOCIATES

## Marko Fabić

Sveučilište u Rijeci  
| University of Rijeka

održavanje  
maintenance

## Valter Uran

TEH-CUT d.o.o.

organizacija proizvodnje  
operations management

## Toni Vidolin

Brodogradilište Viktor Lenac d.d., Rijeka  
| Viktor Lenac Shipyard, Rijeka

zavarivačko inženjerstvo;  
spajanje materijala  
welding engineering;  
joining of materials

## NASTAVA I ZNANOST

### EDUCATION AND SCIENCE

Nastava iz područja: mjerne tehnike i sustava kvalitete, organizacije i operacijskog menadžment, proizvodne tehnologije, proizvodne opreme i robotike, projektiranja procesa, održavanje tehničkih sustava

Lectures in the field of: measuring technique and quality systems, organization and operational management, manufacturing technologies, manufacturing equipments and robotics, process planning, maintenance of technical systems

## KOLEGIJI NA PREDDIPLOMSKIM SVEUČILIŠNIM STUDIJIMA

| UNDERGRADUATE UNIVERSITY COURSES

- Proizvodne tehnologije
- Mjerenja i kontrola kvalitete
- Osiguranje kvalitete
- Zavarivanje I
- Proizvodni strojevi, alati i naprave
- Organizacija i ekonomika poslovnih sustava
- Planiranje i upravljanje proizvodnjom
- Tehnološki procesi
- Manufacturing Technologies
- Measurements and Quality Control
- Quality Assurance
- Zavarivanje I
- Production Machines, Tools, Jigs and Fixtures
- Organization and Economics of Business Entity
- Production Planning and Management
- Technological Processes

## KOLEGIJI NA DIPLOMSKIM SVEUČILIŠNIM STUDIJIMA

| GRADUATE UNIVERSITY COURSES

- Napredni proizvodni postupci
- Obrada odvajanjem čestica
- Tehnologija oblikovanja
- Mjerenje u proizvodnji
- Upravljanje kvalitetom
- Fleksibilni i inteligentni sustavi
- Industrijska robotika
- Zavarivanje II
- Spajanje materijala
- CNC/NC obradni strojevi
- Organizacija proizvodnje
- Projektiranje proizvodnih sustava
- Advanced Manufacturing Processes
- Metal Cutting Processes
- Metal Forming Technology
- Measurement in industry
- Quality Management
- Flexible and intelligent systems
- Industrial robotics
- Welding Engineering II
- Joining of materials
- CNC/NC Machine Tools
- Operations management
- Manufacturing System Design

- Računalom integrirana proizvodnja
- Proizvodni management
- Tehnička logistika
- Management i organizacijski razvoj
- Projektni management
- CAD/CAPP/CAM
- Projektiranje tehnoloških procesa
- Računalna simulacija proizvodnih procesa
- Održavanje

- Computer Integrated Manufacturing
- Production Management
- Technical Logistics
- Management and Organizational Development
- Project Management
- CAD/CAPP/CAM
- Process Planning
- Computer Simulation of Production Processes
- Maintenance

## KOLEGIJI NA PREDDIPLOMSKIM STRUČNIM STUDIJIMA

| UNDERGRADUATE VOCATIONAL COURSES

- Tehnologija obrade I
- Tehnologija obrade II
- Mjerna tehnika ST
- Osiguranje kvalitete ST
- Zavarivanje
- Alati i naprave
- Obradni strojevi
- Organizacija i upravljanje proizvodnjom
- Proizvodni sustavi
- Organizacija i ekonomika
- Tehnološki procesi ST
- Manufacturing Technology I
- Manufacturing Technology II
- Measuring Technique ST
- Quality Assurance ST
- Welding Engineering
- Tools, Jigs and Fixtures
- Machine Tools
- Production Organization and Management
- Production systems
- Organization and Economics
- Technological Processes ST

## KOLEGIJI NA POSLIJEDIPLOMSKIM (DOKTORSKIM) SVEUČILIŠNIM STUDIJIMA

| POSTGRADUATE UNIVERSITY (DOCTORAL) COURSES

- Deformabilnost i suvremeno oblikovanje deformiranjem
- Izabrana poglavlja iz nekonvencionalnih postupaka obrade
- Izabrana poglavlja iz konvencionalne obrade odvajanjem čestica
- Potpuno upravljanje kvalitetom
- Inženjerstvo kvalitete
- Metode simulacije u proizvodnji
- Planiranje i vođenje proizvodnje
- IP iz fleksibilnih proizvodnih sustava
- Razvojni i proizvodni management
- CAM, CAP, CAD/NC-CIM
- Optimizacija tehnoloških procesa
- Održiva proizvodnja
- Formability and Modern Forming Technology
- Selected Chapters on Nonconventional Manufacturing Processes
- Selected Chapters on Conventional Metal Cutting Processes
- Total Quality Management
- Quality Engineering
- Simulation Methods in Production
- Planning and Processing of Manufacture
- Selected Chapters from flexible production system
- Development and Operational Management
- CAM, CAP, CAD/NC-CIM
- Processes Plans Optimization
- Sustainable manufacturing

## ZNANSTVENOISTRAŽIVAČKI RAD | SCIENTIFIC RESEARCH

- Napredni obradni sustavi i tehnologije, tehnologija oblikovanja deformiranjem, modeliranje i optimiranje obradnih procesa, računalna simulacija proizvodnih procesa  
Advanced manufacturing systems and technology, forming technology, modelling and optimisation of machining processes, computational simulation of production processes
- Modeliranje, simulacija i optimizacija procesa obrade. Primjena umjetne inteligencije u upravljanju procesima obrade.  
Modeling, simulation and optimization of manufacturing processes. Application of artificial intelligence in control of manufacturing processes.



- **Industrijsko inženjerstvo, upravljanje i osiguranje kvalitete, mjerenja i kontrola kvalitete, mjerenja u proizvodnji, spajanje materijala, zavarivanje**  
*Industrial engineering, quality management, quality assurance, measurements and quality control, industrial measurements, joining of materials, welding*
- **Proizvodno strojarstvo; proizvodni sustavi; CIM, planiranje i upravljanje proizvodnjom, proizvodni management, organizacija poslovnih sustava**  
*Production engineering, manufacturing systems, CIM, production planning and control, production management, organization of manufacturing and business systems*

## PROJEKTI | PROJECTS

- **Primjena tehnologija inkrementalnog oblikovanja u individualnoj proizvodnji izradaka iz naprednih polimernih materijala, uniri-tehnic-18-100-1235, istraživačka potpora Sveučilišta u Rijeci, Zoran Jurković, 2018.-2021., znanstvenoistraživački projekt.**  
*Application of incremental forming technologies in individual production of parts from advanced polymer materials, uniri-tehnic-18-100-1235, University of Rijeka, Zoran Jurkovic, 2018.-2021., research and scientific project.*
- **Razvoj metodologije projektiranja i postupka umjeravanja rekonfigurabilnog mjernog sustava, Sveučilište u Rijeci, Duško Pavletić, 2018.-2021., znanstvenoistraživački projekt.**  
*Design principles and calibration method of reconfigurable inspection system, University of Rijeka, Duško Pavletić, 2018.-2021., research and scientific project.*
- **Istraživanje alternativnih tehnika hlađenja-podmazivanja za održivu strojnu obradu teško obradivih materijala, uniri-tehnic-18-293, istraživačka potpora Sveučilišta u Rijeci, Goran Cukor, 2018.-2021., znanstvenoistraživački projekt**  
*Investigation of alternative cooling-lubrication techniques for sustainable machining of difficult-to-cut materials, uniri-tehnic-18-293, University of Rijeka, Goran Cukor, 2018-2021, research and scientific project*
- **Napredne metode simulacije operativne pripreme planiranja proizvodnje, istraživačka potpora Sveučilišta u Rijeci, Mladen Perinić, 2018.-2021., znanstvenoistraživački projekt.**  
*Advanced methods of simulating the operational preparation of production planning, University of Rijeka, Mladen Perinić, 2018.-2021., research and scientific project.*
- **Razvoj ekoloških proizvodnih procesa i novih proizvoda visoke kvalitete aktivnostima istraživanja i razvoja, OP Konkurentnost i kohezija 2014.-2020., Sandro Doboviček, 2020.-2023., znanstvenoistraživački projekt**  
*Development of ecological production processes and new products of high quality through research and development activities, Operational programme competitiveness and cohesion 2014 - 2020, Sandro Doboviček, 2020.-2023., research and scientific project.*
- **MQL tehnika podmazivanja u kombinaciji s hlađenjem vrtložnom cijevi za održivo tokarenje teško obradivog austenitnog nehrđajućeg čelika, uniri-mladi-tehnic-20-12, UNIRI PROJEKTI MLADIH ZNANSTVENIKA I UMJETNIKA, Sveučilište u Rijeci, Graciela Šterpin Valić, 2021.-2022., UNIRI potpore projektnim aktivnostima mladih znanstvenika i umjetnika**  
*MQL lubrication technique in combination with vortex tube cooling for sustainable turning of difficult-to-cut austenitic stainless steel, uniri-mladi-tehnic-20-12, UNIRI PROJECTS OF YOUNG SCIENTISTS AND ARTISTS, University of Rijeka, Graciela Šterpin Valić, 2021.-2022., UNIRI supports to project activities of young scientists and artists*

## PUBLIKACIJE | PUBLICATIONS

## RADovi U ČASOPISIMA | JOURNAL PAPERS

- **Brić, T.; Rešković, S.; Jurković, Z.; Janeš, G., Mathematical Modeling of Influence Parameters During Formation and Propagation of the Lüders Bands, Facta Universitatis Series: Mechanical Engineering, ISSN 0354-2025, Vol. 18, No. 4, 596-610, 2020, Srbija**

- **Fabić, M.; Pavletić, D.; Šterpin Valić, G., Factors in Turnaround Refinery (TAR) Project Management Process, Tehnički vjesnik: znanstveno-stručni časopis tehničkih fakulteta Sveučilišta u Osijeku, ISSN 1330-3651, Vol. 27, No. 5, 1367-1377, 2020, Hrvatska**
- **Ištoković, D.; Perinić, M.; Vlatković, M.; Brezočnik, G., Minimizing total production cost in a hybrid flow shop: a simulation optimization approach, International Journal of Simulation Modelling, ISSN 1726-4529, Vol. 19, No. 4, 559-570, 2020., Austrija**
- **Ištoković, D.; Perinić, M.; Borić, A., Determining the minimum waiting times in a hybrid flow shop using simulation-optimization approach, Tehnički vjesnik / Technical Gazette, ISSN 1330-3651, Vol. 28, No. 2, 568-575, 2021., Hrvatska**
- **Randić, M.; Pavletić, D.; Fabić, M., Evaluation of the Stress Concentration Factor in Butt Welded Joint: A Comparative Study, Metals, ISSN 2075-4701, Vol. 11, No. 3, 411-421, 2021, Switzerland**
- **Rabar, D.; Pavletić, D.; Doboviček, D.; Vlatković, M., Dry-docking performance measurement model – multi criteria non parametric approach Ships and Offshore Structures, (doi.org/10.1080/17445302.2021.1907085), ISSN: 1754-212X, Online / Ahead-of-print, 1-8, 2021, Online**
- **Rabar D.; Rabar D.; Pavletić D., Two-Step Manufacturing Process Measurement Model Using Qualitative and Quantitative Data—A Case of Newbuilding Dry-Docking, Journal of Marine Science and Engineering, ISSN: 2077-1312, Vol. 9, No. 5, 464-481, 2021, Switzerland**

## MEĐUNARODNI KONGRESI | INTERNATIONAL CONGRESSES

- **Randić, M.; Pavletić, D.; Bevandić, I.; Jerčić, D., Impact of welding parameters on weld quality for high-strength steel used at low temperature, XXIV. simpozij Teorija i praksa brodogradnje in memoriam prof. Leopold Sotra, e-Proceedings, Rijeka, ISBN 978-953-8246-20-3, 472-482, 2020, Rijeka**
- **Hozdić, E.; Jurkovic, Z., The Electro-Pneumatic System as a Cyber - Physical System: The Concept, New Technologies, Development and Application IV, ISBN 978-3-030-75274-3, 239-250, 2021, Švicarska**

## MEĐUNARODNA SURADNJA | INTERNATIONAL COLLABORATIONS

- **Università degli Studi di Udine, Facoltà di Ingegneria, Dipartimento di Ingegneria Elettrica, Gestionale e Meccanica (DIEGM), Italia, Italija, Italy**
- **University of Maribor, Faculty of Mechanical Engineering, Production Engineering Institute, Slovenija, Slovenia**
- **University of Kragujevac, Faculty of Engineering, Department for Production Engineering, Srbija, Serbia**
- **University of Novi Sad, Faculty of Technical Sciences, Department of Production Engineering, Srbija, Serbia**
- **University of Montenegro, Faculty of Mechanical Engineering, Podgorica, Crna Gora, Montenegro**
- **University of Banja Luka, Faculty of Mechanical Engineering, Bosna i Hercegovina, Bosnia & Herzegovina**
- **Ss. Cyril and Methodius University in Skopje, Faculty of Mechanical Engineering, Institute of Production Engineering and Management, Republika Makedonija, Republic of Macedonia**
- **Faculty of Mechanical Engineering, University of Zilina, Slovačka, Slovakia**
- **Poznan Politechnic, Technical University of Poznan, Poljska, Poland**
- **University of Ljubljana, Faculty of Mechanical Engineering, Slovenija, Slovenia**

**5<sup>5</sup>**

**ZAVOD ZA KONSTRUIRANJE  
U STROJARSTVU**

DEPARTMENT OF MECHANICAL  
ENGINEERING DESIGN





## DJELATNICI FACULTY AND STAFF

### PREDSTOJNICA ZAVODA | DEPARTMENT HEAD:



Doc. dr. sc. / Assist. Prof. D. Sc. **Kristina Marković**

*inženjerska grafika; dokumentiranje; tehničko crtanje; oblikovanje pomoću računala; tehničko dokumentiranje; precizno inženjerstvo; konstrukcijski elementi robota*  
engineering graphics; documenting; technical drawing; modelling by computer; technical documenting; precision engineering; robot elements design

### REDOVITI PROFESORI U TRAJNOM ZVANJU | TENURED PROFESSORS



**Neven Lovrin**

*konstrukcijski elementi; mehanički prijenosnici snage; transportna sredstva u industriji; brodski palubni strojevi; tehnička logistika; inženjerska etika*  
machine elements; mechanical power transmissions; industrial transport equipment and devices; ship's deck machinery; technical logistics; engineering ethics



**Saša Zelenika**

*precizno inženjerstvo; tehnologija mikrosustava; MEMS i NEMS; sustavi žetve energije; mjerni sustavi; konstrukcijski elementi; mehatronika*  
precision engineering; microsystems technologies; MEMS and NEMS; energy harvesting devices; measurement systems; machine elements; mechatronics

### REDOVITI PROFESORI | PROFESSORS



**Robert Basan**

*ponašanje i zamor materijala; odabir materijala; konstruiranje i oblikovanje proizvoda; metodičko konstruiranje; računalom podržano inženjerstvo (CAE)*  
behaviour and fatigue of materials; material selection; product design in mechanical engineering; systematic engineering design; computer aided engineering (CAE)



**Marina Franulović**

*konstrukcijski elementi; mehaničke konstrukcije; modeliranje oštećenja i analiza nosivosti elemenata i sklopova*  
machine elements; mechanical design of machine components; damage modelling and load carrying capacity analysis of elements and components

### DOCENTI | ASSISTANT PROFESSORS

**Goran Gregov**

*prijenosnici snage; hidraulika i pneumatika; mehatronika*  
power transmissions; hydraulics and pneumatics; mechatronics



**Ervin Kamenar**

*precizno inženjerstvo; mehatronika; meki roboti; sustavi regulacije i upravljanja; sustavi žetve energije; tehnologija mikrosustava; mjerni sustavi*  
precision engineering; mechatronics; compliant robotics; control systems; energy harvesting systems; microsystems technologies; measurement systems



**Tea Marohnić**

*ponašanje i zamor materijala; inženjerska grafika; tehničko crtanje; oblikovanje pomoću računala; CAE; metodičko konstruiranje; konstruiranje i oblikovanje proizvoda*  
behaviour and fatigue of materials; engineering graphics; technical drawing; modelling by computer; CAE; systematic product design; design in mechanical engineering



**Jelena Srnec Novak**

*numeričko modeliranje ponašanja materijala; termo-mehanički zamor materijala; numeričke metode; nanoindentacija; inženjerska grafika; konstrukcijski elementi; oblikovanje pomoću računala; konstruiranje i oblikovanje*  
Numerical modeling of material behavior; thermo-mechanical fatigue; numerical methods; nanoindentation; engineering graphics; machine element design; modeling by computer; design in mechanical engineering



**Sanjin Troha**

*inženjerska grafika; dokumentiranje; tehničko crtanje; oblikovanje pomoću računala; konstrukcijski elementi*  
engineering graphics; documenting; technical drawing; modelling by computer; machine elements



**Željko Vrcan**

*konstrukcijski elementi; mehanički prijenosnici snage; transportna sredstva u industriji; mjerenje buke*  
machine elements; mechanical power transmissions; industrial transport equipment and devices; noise measurement



### POS LIJEDOKTORAND | POSTDOCTORAL RESEARCH ASSISTANT

**Marko Perčić**

*inženjerska grafika; dokumentiranje; tehničko crtanje; oblikovanje pomoću računala; tehničko dokumentiranje; tehnologija nanosustava; tribologija*  
engineering graphics; documenting; technical drawing; modelling by computer; technical documenting; nanosystems technology; tribology



## ASISTENTI | ASSISTANTS

**Tomislav Bazina**

*precizno inženjerstvo; konstrukcijski elementi; mjerni sustavi; mehatronika*

*precision engineering; machine elements; measurement systems; mechatronics*

**Maja Dundović**

*inženjerska grafika; tehničko crtanje; oblikovanje pomoću računala; konstrukcijski elementi; konstrukcijski elementi robota*

*engineering graphics; technical drawing; modelling by computer; machine elements; robot elements design*

**Matej Gljuščić**

*konstrukcijski elementi; elementi strojeva; mehaničke konstrukcije; napredni materijali; modeliranje ponašanja materijala*

*machine elements design; machine elements; mechanical design of machine components; advanced materials; modeling of material behaviour*

**Petar Gljuščić**

*precizno inženjerstvo; sustavi žetve energije; konstrukcijski elementi; mjerni sustavi*

*precision engineering; energy harvesting devices; machine elements; measurement systems*

**David Liović**

*konstrukcijski elementi; mehaničke konstrukcije; napredni materijali; modeliranje ponašanja materijala*

*machine elements design; mechanical design of machine components; advanced materials; modeling of material behaviour*

## PROFESOR EMERITUS | PROFESSOR EMERITUS

**Božidar Križan**

*konstrukcijski elementi; konstruiranje i oblikovanje proizvoda*

*machine elements; systematic product design*

*Nastava se izvodi iz područja: konstruiranje u strojarstvu, numeričke metode u konstruiranju, konstrukcijski elementi, mehanički prijenosnici snage, hidrostatski i pneumatski sustavi prijenosa snage i upravljanja, zupčani prijenosnici, tribologija, transportna sredstva u industriji, brodski palubni strojevi, tehnička logistika, mehatronika, precizno inženjerstvo, tehnologija mikrosustava, MEMS i NEMS, mjerni sustavi, inženjerska grafika i dokumentiranje, oblikovanje pomoću računala, inženjerska vizualizacija, metoda rubnih elemenata.*

*CO: Oblikovanje 3D modela, Oblikovanje pomoću računala CO*

## KOLEGIJI NA PREDDIPLOMSKIM SVEUČILIŠNIM STUDIJIMA

| UNDERGRADUATE UNIVERSITY COURSES

- Inženjerska grafika
- Inženjerska grafika i dokumentiranje
- Izborni projekt - Konstruiranje i oblikovanje
- Izborni projekt - Konstrukcijski elementi II
- Konstruiranje i oblikovanje
- Konstrukcijski elementi II
- Oblikovanje pomoću računala
- Osnove konstruiranja
- Osnove konstrukcijskih elemenata

NASTAVA I ZNANOST  
EDUCATION AND SCIENCE

*Lectures in the field of: design in mechanical engineering, numerical methods in design, machine elements, mechanical power transmissions, fluid power systems and control, gear transmissions, tribology, industrial transport equipment and devices, ship's deck machinery, technical logistics, mechatronics, precision engineering, microsystems technologies, MEMS and NEMS, measurement systems, engineering graphics and documenting, modelling by computer, engineering visualization, boundary element method.*

*LLL: 3D modelling, Modelling by Computer CO*

## KOLEGIJI NA DIPLOMSKIM SVEUČILIŠNIM STUDIJIMA

| GRADUATE UNIVERSITY COURSES

- Brodski palubni strojevi
- CAE u razvoju proizvoda
- Elementi transportne tehnike
- Inženjerska vizualizacija
- Komponente mehatroničkih sustava
- Konstrukcijski elementi robota
- Laboratorijske vježbe A
- Laboratorijske vježbe B
- Mehaničke konstrukcije
- Mehaničko ponašanje i odabir materijala
- Metodičko konstruiranje
- Mikro- i nanoelektromehanički sustavi
- Modeliranje hidrauličkih i pneumatskih sustava
- Numeričke metode u konstruiranju
- Ship's Deck Machinery
- CAE in Product Development
- Elements of the Transport Technic
- Engineering Visualization
- Components of mechatronic systems
- Robot Elements Design
- Laboratory exercises A
- Laboratory exercises B
- Mechanical Design of Machine Components
- Mechanical Behaviour and Selection of Materials
- Systematic Engineering Design
- Micro- and Nanoelectromechanical Systems
- Modelling of hydraulics and pneumatics systems
- Numerical Methods in Mechanical Engineering Design





- |   |  |  |  |  |
|---|--|--|--|--|
| <ul style="list-style-type: none"> <li>• Precizne konstrukcije i tehnologija mikrosustava</li> <li>• Prijenosnici snage</li> <li>• Projekt I - Komponente mehatroničkih sustava</li> <li>• Projekt I - Inženjerska vizualizacija</li> <li>• Projekt I - Konstrukcijski elementi robota</li> <li>• Projekt I - Mehaničke konstrukcije</li> </ul> | <ul style="list-style-type: none"> <li>• Precision Engineering and Microsystems Technologies</li> <li>• Power Transmissions</li> <li>• Project I - Components of mechatronic systems</li> <li>• Project I - Engineering Visualization</li> <li>• Project I - Robot Elements Design</li> <li>• Project I - Mechanical Design of Machine Components</li> </ul> |  |  |  |
| <ul style="list-style-type: none"> <li>• Projekt I - Metodičko konstruiranje</li> <li>• Projekt I - Prijenosnici snage</li> <li>• Projekt II - CAE u razvoju proizvoda</li> <li>• Projekt II - Elementi transportne tehnike</li> </ul>  | <ul style="list-style-type: none"> <li>• Project I - Systematic Engineering Design</li> <li>• Project I - Mechanical Power Transmissions</li> <li>• Project II - CAE in Product Development</li> <li>• Project II - Elements of the Transport Technic</li> </ul>   |  |  |  |
| <ul style="list-style-type: none"> <li>• Projekt II - Modeliranje hidrauličkih i pneumatskih sustava</li> <li>• Projekt II - Precizne konstrukcije i tehnologija mikrosustava</li> <li>• Tehnička logistika</li> <li>• Transportni sustavi</li> <li>• Upravljanje mehatroničkim sustavima</li> </ul>  | <ul style="list-style-type: none"> <li>• Project II - Modelling of hydraulics and pneumatics</li> <li>• Project II - Precision Engineering and Microsystems Technologies</li> <li>• Technical Logistics</li> <li>• Transport Systems</li> <li>• Control of Mechatronics Systems</li> </ul>   |  |  |  |

- Karakterizacija i numeričko modeliranje ponašanja materijala  
Characterisation and numerical modelling of material behaviour
- Konstrukcijsko strojarstvo  
Mechanical engineering design
- Kontaktni problemi u konstrukcijskim elementima  
Contact problems in machine elements
- Modeliranje  
Modelling
- Precizno inženjerstvo: podatljivi mehanizmi, pozicioniranje ultravisokih preciznosti i točnosti, strukturna analiza, integracija u mehatroničke sustave, mjerne tehnike  
Precision engineering: compliant mechanisms, ultra-high precision positioning, structural analysis, integration into mechatronics devices, measurement techniques.
- Prijenos energije i informacija u hidrauličkim i pneumatskim sustavima  
The energy and information transmission in hydraulic and pneumatic systems
- Procjena parametara materijala primjenom klasičnih metoda i neuronskih mreža  
Estimation of material properties by means of classical methods and neural networks
- Tehnologija mikro- i nanosustava: MEMS, manipulacija, montaža i pakiranje, skalirajući učinci, proizvodnja mikrostruktura, prikupljanje niskorazinske energije iz okoliša, tribologija  
Micro- and nanosystems technologies: MEMS, handling, assembly and packaging, scaling effects, micro-fabrication, energy harvesting, tribology

- Zamor materijala  
Fatigue of materials
- Zupčasti prijenosnici, planetarni prijenosi, evolventno ozubljenje s velikim stupnjem prekrivanja profila, transportni sustavi, inženjerska etika  
Gear transmissions, planetary gears, high transverse contact ratio gears, transport systems, engineering ethics
- Mehaničko ponašanje materijala  
Mechanical behaviour of materials
- Mjerenje buke, ispitivanje ispravnosti rada strojeva  
Noise measurement and testing of machine operation
- Fotoelastična ispitivanja  
Photoelastic Measurement
- Višebrzinski mehanički pretvarači  
Multi-speed mechanical convertors
- Meka robotika  
Compliant robotics

#### PROJEKTI | PROJECTS

- Karakterizacija i istraživanje ponašanja naprednih materijala za strojarske komponente, projekt Sveučilišta u Rijeci, voditeljica Marina Franulović, 2018-2021  
Characterization and behavior research of advanced materials for mechanical components, Project of University of Rijeka, Marina Franulović, 2018-2021
- Inovativne mehatroničke konstrukcije za pametna tehnološka rješenja, znanstveni projekt Sveučilišta u Rijeci, voditelj Saša Zelenika, 2019-2022

#### KOLEGIJI NA PREDDIPLOMSKIM STRUČNIM STUDIJIMA

| UNDERGRADUATE VOCATIONAL COURSES

- |  |  |  |  |  |
|--|--|--|--|--|
| <ul style="list-style-type: none"> <li>• Elementi strojeva I</li> <li>• Elementi strojeva I BG</li> <li>• Elementi strojeva II</li> <li>• Hidraulika i pneumatika</li> <li>• Konstruiranje</li> <li>• Osnove mehatronike</li> <li>• Tehničko crtanje</li> <li>• Tehničko dokumentiranje</li> </ul> | <ul style="list-style-type: none"> <li>• Machine Elements I</li> <li>• Machine Elements I NA</li> <li>• Machine Elements II</li> <li>• Hydraulics and pneumatics</li> <li>• Mechanical Engineering Design</li> <li>• Fundamentals of Mechatronics</li> <li>• Technical Drawing</li> <li>• Technical Documenting</li> </ul> |  |  |  |
|--|--|--|--|--|

#### KOLEGIJI NA POSLIJEDIPLOMSKIM (DOKTORSKIM) SVEUČILIŠNIM STUDIJIMA

| POSTGRADUATE UNIVERSITY (DOCTORAL) COURSES

- |  |  |  |  |  |
|--|--|--|--|--|
| <ul style="list-style-type: none"> <li>• Izabrana poglavlja iz hidrostatskih i pneumatskih prijenosa</li> <li>• Izabrana poglavlja iz konstrukcijskih elemenata</li> <li>• Višebrzinski mehanički pretvarači</li> <li>• Izabrana poglavlja iz zupčastih prijenosnika</li> <li>• Izabrana poglavlja iz transportnih sredstava u industriji</li> <li>• Modeliranje oštećenja i analiza nosivosti elemenata i sklopova</li> </ul> | <ul style="list-style-type: none"> <li>• Selected Chapters on Hydrostatic and Pneumatic Transmissions</li> <li>• Selected Chapters on Machine Elements</li> </ul>  |  |  |  |
| <ul style="list-style-type: none"> <li>• Modeliranje naprednih inženjerskih konstrukcija iz inovativnih materijala</li> <li>• Izabrana poglavlja iz znanosti o konstruiranju</li> <li>• Podatljivi elementi i mehanizmi</li> <li>• Principi konstrukcija visokih i ultravisokih preciznosti</li> <li>• Specijalni mehanički prijenosnici</li> </ul>  | <ul style="list-style-type: none"> <li>• Multi-speed mechanical convertors</li> <li>• Selected Chapters on Gear Transmissions</li> <li>• Selected Chapters on Industrial Transport Equipment and Devices</li> <li>• Damage modelling and load carrying capacity analysis of elements and components</li> <li>• Design of advanced engineering constructions made of innovative materials</li> <li>• Selected Chapters on Design Science</li> </ul> |  |  |  |
| <ul style="list-style-type: none"> <li>• Hidrostatski pogoni, Pneumatski sustavi</li> </ul>  | <ul style="list-style-type: none"> <li>• Compliant Elements and Mechanisms</li> <li>• Principles of High and Ultra-High Precision Devices</li> <li>• Special Mechanical Transmissions</li> </ul>   |  |  |  |

#### ZNANSTVENOISTRAŽIVAČKI RAD | SCIENTIFIC RESEARCH

- Hidrostatski pogoni, Pneumatski sustavi  
Hydrostatic transmission, Pneumatic systems

Advanced mechatronics devices for smart technological solutions, University of Rijeka scientific project, Saša Zelenika, 2019-2022

- **Istraživanje i razvoj prediktivnih modela ponašanja konstrukcijskih materijala temeljenih na metodama strojnog učenja, Potpore znanstvenim istraživanjima na Sveučilištu u Rijeci, voditelj Robert Basan, 2018-2022**  
Research and development of machine learning-based predictive models of design relevant materials, Support for Research at the University of Rijeka, principal investigator Robert Basan, 2018-2022
- **Optimising Design for Inspection (ODIN), EU COST akcija CA18203, voditelj WG 3 i hrvatski član Upravnog odbora je Saša Zelenika, 2019-2023**  
Optimising Design for Inspection (ODIN), EU COST Action CA18203, WG 3 leader and Croatian MC member is Saša Zelenika, 2019-2023
- **Tribološka karakterizacija materijala od nanometarske do makrometarske razine, bilateralni projekt znanstveno-tehnološke suradnje Hrvatska-Slovenija, voditelj hrvatskog dijela je Saša Zelenika, 2020-2021.**  
Tribological material characterisation from the nanometric to the macrometric domain, Croatian-Slovenian bilateral project of scientific and technological cooperation, leader of the Croatian participation is Saša Zelenika, 2020-2021.
- **InterReg projekt Italija – Slovenija „Nano-region“, voditelj suradničkog tima Sveučilišta u Rijeci je Saša Zelenika, 2019-2022.**  
Italy-Slovenia InteReg project “Nano-region”, leadership of the University of Rijeka, Croatia associate partnership team is Saša Zelenika, 2019-2022.
- **Mjerenje vibracija na transformatoru, tehnološki projekt u suradnji s tvrtkom Končar D&ST, voditelj Saša Zelenika, 2019-2021.**  
Measurement of vibrations on a transformer, technological project in collaboration with the Končar D&ST company, leader Saša Zelenika, 2019-2021.
- **Modeliranje i simulacija u razvoju naprednih materijala - SIMMAT, Istraživački projekt Hrvatske zaklade za znanost, IP-2019-04-3607, voditeljica Marina Franulović 2019-2023**  
Modelling and simulation in development of advanced materials - SIMMAT, Research project supported by Croatian Science Foundation IP-2019-04-3607, principal investigator Marina Franulović, 2019-2023
- **Ponašanje monolitnih podatljivih mehanizama izrađenih aditivnim tehnologijama, UNIRI-plus projekt, voditeljica Kristina Marković 2019-2021**  
Behavior of monolithic compliant mechanisms developed by additive technologies, UNIRI-plus project, principal investigator Kristina Marković 2019-2021
- **YUFERING - YUFE transformira istraživanje i inovacije putem transfera znanja na europskoj razini, EU Obzor 2020 projekt, Saša Zelenika je UNIRI/RITEH institucijski koordinator i voditelj WP3, 2021-2024.**  
YUFERING - YUFE Transforming R&I Through Europe-Wide Knowledge Transfer, EU H2020 project, Saša Zelenika is the UNIRI/RITEH institutional coordinator and leader of WP3, 2021-2024.
- **Razvoj i implementacija praktičnog učenja o otvorenoj znanosti i otvorenim inovacijama za mlade istraživače — DIOSI, EU Obzor 2020 projekt, Saša Zelenika je UNIRI voditelj projekta, 2021-2022.**  
Developing and Implementing hands-on training on Open Science and Open Innovation for Early Career Researchers — DIOSI, EU H2020 project, Saša Zelenika is the UNIRI project leader, 2021-2022.

- **Inno4YUFE - razvoj inovativnog europskog sveučilišta koje osnažuje novu generaciju studenata - poduzetnika i inovatora, EU projekt financiran kroz EIT shemu „HEI Initiative: Innovation Capacity Building for Higher Education“, Saša Zelenika je UNIRI voditelj projekta, 2021-2022.**  
Inno4YUFE - Towards a pioneering European University that powers a new generation of student entrepreneurs and innovators, EU project financed via the EIT scheme „HEI Initiative: Innovation Capacity Building for Higher Education“, Saša Zelenika is the UNIRI project leader, 2021-2022.
- **Razvoj modela za procjenu ponašanja materijala temeljenih na strojnom učenju - MADEIRA, Istraživački projekt Hrvatske zaklade za znanost, IP-2020-02-5764, voditelj Robert Basan 2020-2024**  
Development of machine learning-based models for materials behavior estimation - MADEIRA, Research project supported by Croatian Science Foundation IP-2020-02-5764, principal investigator Robert Basan, 2020-2024
- **Razvoj naprednih metoda za procjenu elasto-plastičnog ponašanja materijala temeljen na nanoindentacijskim podacima, UNIRI projekti mladih znanstvenika i umjetnika, uniri-mladi-tehnic-20-18, voditeljica projekta Jelena Smec Novak, 2021-2022**  
Development of advanced methods to assess the elasto-plastic material behaviour using nanoindentation data, UNIRI project of young scientists and artists, uniri-mladi-tehnic-20-18, project leader Jelena Smec Novak, 2021-2022
- **Višerazniska karakterizacija trenja korištenjem inovativnog interdisciplinarnog pristupa, UNIRI projekti mladih znanstvenika i umjetnika, uniri-mladi-tehnic-20-15, voditelj projekta Marko Perčić, 2021-2022**  
Multiscale Characterization of Friction by Using an Innovative Interdisciplinary Approach, UNIRI project of young scientists and artists, uniri-mladi-tehnic-20-15, project leader Marko Perčić, 2021-2022

#### PUBLIKACIJE | PUBLICATIONS

##### KNJIGE | BOOKS

- **Karaivanov, D.; Troha, S., Optimal Selection of the Structural Scheme of Compound Two-Carrier Planetary Gear Trains and their Parameters”, pp. 339-403 in: Radzevich, S.P., (Editor), Recent Advances in Gearing: Scientific Theory and Applications Springer Nature, ISBN-10: 3030646378, ISBN-13: 978-3030646370, 2021, Cham, Switzerland**

##### RADOVI U ČASOPISIMA | JOURNAL PAPERS

- **Zelenika, S.; Hadas, Z.; Bader, S.; Becker, T.; Gljušćić, P.; Hlinka, J.; Janak, L.; Kamenar, E.; Ksica, F.; Kyratsi, T.; Louca, .; Mrlik, M.; Osmanović, A.; Pakrashi, V.; Rubes, O.; Ševeček, O.; Silva, José P. B.; Tofel, P.; Trkulja, B.; Unnthorsson, R.; Velagić, J.; Vrcan, Ž., Energy harvesting technologies for structural health monitoring of airplane components – A review, Sensors 1424-8220, 20 (22), 6685, 2020., inozemstvo**
- **Perčić, M.; Zelenika, S.; Mezić, I., Artificial intelligence-based predictive model of nanoscale friction using experimental data, Friction, 2223-7690, 9 (6), 1726-1748, 2021., inozemstvo**
- **Smokvina Hanza, S.; Marohnić, T.; Iljkić, D.; Basan, R., Artificial Neural Networks-Based Prediction of Hardness of Low-Alloy Steels Using Specific Jominy Distance, Metals, 2075-4701, 11 (5) 1-14, 2021., inozemstvo**
- **Pelegatti, M.; Lanzutti, A.; Salvati, E.; Srnc Novak, J.; De Bona, F.; Benasciutti, D., Cyclic Plasticity and Low Cycle Fatigue of an AISI 316L Stainless Steel: Experimental Evaluation of Material Parameters for Durability Design, Materials, 1996-1944, 14 (13), 1-20, 2021., inozemstvo**



- Theochari, G.; Troha, S.; Karaivanov, D., Reducer with a planetary gear train for a hoisting mechanism of dangerous goods cranes, *INTERNATIONAL SCIENTIFIC JOURNAL "TRANS & MOTAUTO WORLD"*, 2534-8493, 5 (4), 125-128, 2020, inozemstvo
- Theochari, G.; Troha, S.; Karaivanov, D., Some requirements to the mechanisms of handling machines for dangerous goods and solutions for the satisfaction, *INTERNATIONAL SCIENTIFIC JOURNAL "TRANS & MOTAUTO WORLD"*, 2534-8493, 5(4), 121-124, 2020, inozemstvo
- Zibar Belasic, T.; Pejova, B.; Otmacic Curkovic, H.; Kamenar, E.; Cetenovic, B.; Spalj, S., Influence of intraoral application of antiseptics and fluorides during orthodontic treatment on corrosion and mechanical characteristics of nickel-titanium alloy in orthodontic appliances *The Angle Orthodontist*, 0003-3219, 91(4), 528-537, 2021, inozemstvo
- Otmacic Curkovic, H.; Ivanko, M.; Pop Acev, D.; Kamenar, E.; Jelovica Badovinac, I.; Spalj, S., Corrosion of Dental Alloys Used for Mini Implants in Simulated Oral Environment, *International Journal of Electrochemical Science*, 1452-3981, 16, 2021, inozemstvo
- Malenica, M.; Vukomanović, M.; Kurtjak, M.; Masciotti, V.; dal Zilio, S.; Greco, S.; Lazzarino, M.; Krušić, V.; Perčić, M.; Jelovica Badovinac, I.; Wechtersbach, K.; Vidović, I.; Baričević, V.; Valić, S.; Lučić, P.; Kojc, N.; Grabušić, K., Perspectives of Microscopy Methods for Morphology Characterisation of Extracellular Vesicles from Human Biofluids, *Biomedicines*, 2227-9059, 9 (6) 603-632, 2021, inozemstvo
- Franulović, M.; Marković, K.; Trajkovski, A., Calibration of material models for the human cervical spine ligament behaviour using a genetic algorithm, *Facta Universitatis, Series: Mechanical Engineering*, online first, 2021, inozemstvo
- Liović, D.; Franulović, M.; Kozak, D., Material models and mechanical properties of titanium alloys produced by selective laser melting, *Procedia Structural Integrity*, 2021
- Dundović, M.; Marković, K.; Franulović, M.; Vrcan, Ž., Digital light processing in photoelastic models production for material behavior modeling, *Procedia Structural Integrity*, 2021
- Gljuščić, M.; Franulović, M.; Lanc, D.; Božić, Ž., Digital image correlation of additively manufactured CFRTP composite systems in static tensile testing, *Procedia Structural Integrity*, 2021
- Srnc Novak, J.; Franulović, M.; Benasciutti, D.; De Bona, F., Modeling the cyclic plasticity behavior of 42CrMo4 steel with an isotropic model calibrated on the whole shape of the evolution curve, *Procedia Structural Integrity*, 2021, inozemstvo
- Troha, S.; Karaivanov, D.; Vrcan, Ž.; Marković, K.; Šoljić, A., Coupled two-carrier planetary gearboxes for two-speed drives, *INTERNATIONAL SCIENTIFIC JOURNAL "MACHINES. TECHNOLOGIES. MATERIALS"*, 1313-0226, 15 (6), 212-218, 2021
- Alisomanova, A.; Troha, S.; Karaivanov, D., A hoisting mechanism of clamshell cranes with a planetary gear train, *INTERNATIONAL SCIENTIFIC JOURNAL "MACHINES. TECHNOLOGIES. MATERIALS"*, 1313-0226, 15 (5), 176-180, 2021

#### MEĐUNARODNI KONGRESI | INTERNATIONAL CONGRESSES

- Marohnić, T.; Basan, R., Estimation of materials' parameters of strain-life fatigue behavior using empirical and artificial neural networks based approach, *26th International Conference on Fracture and Structural Integrity, IGF26*, 2021, Torino, Italija i virtualno okruženje
- Srnc Novak, J.; Kamenar, E.; Zelenika, S.; De Bona, F.; Piovesana, L., Methodological correlation of finite element models to nanoindentation measurements on Si (100), *Proceedings of the 21th EUSPEN International Conference*, 105-108, 2021, Cranfield, UK i virtualno okruženje

- Kamenar, E.; Črnjarić-Žic, N.; Haggerty, D.; Zelenika, S.; Hawkes, Elliot W.; Mezić, I., Prediction of the behavior of a pneumatic soft robot based on Koopman operator theory, *Proceedings of the 43rd MIPRO International Convention*, 1417-1421, 2020, Opatija, Hrvatska i virtualno okruženje
- Gljuščić, P.; Zelenika, S., Coupled electromechanical behaviour of kinetic energy harvesters for SHM, *International Conference on Advances in Energy Harvesting Technology*, 2021, Virtualno okruženje
- Perčić, M.; Zelenika, S.; Mezić, I., Multivariate AI-based predictive model of nanoscale friction, *Proceedings of the 21th EUSPEN International Conference*, 121-124, 2021, Cranfield, UK i virtualno okruženje
- Perčić, M.; Mio, A.; Zelenika, S.; Fermeglia, M., A molecular dynamics study of nanometric scale friction, *Proceedings of the 21th EUSPEN International Conference*, 125-126, 2021, Cranfield, UK i virtualno okruženje
- Gljuščić, P.; Zelenika, S.; Perčić, M.; Kamenar, E., Experimental characterisation of performances of optimized piezoelectric energy harvesters, *Proceedings of the 21th EUSPEN International Conference*, 131-134, 2021, Cranfield, UK i virtualno okruženje
- Bazina, T.; Zelenika, S.; Kamenar, E.; Škifić, A.; Schnurrer-Luke-Vrbanić, T., Kinematic characterization and validation of an upper limb rehabilitation device, *Proceedings of the 21th EUSPEN International Conference*, 205-208, 2021, Cranfield, UK i virtualno okruženje
- Mio, A.; Marson, D.; Laurini, E.; Pricl, S.; Fermeglia, M.; Perčić, M.; Zelenika, S., Investigation of friction force trends at the nanoscale using computation approach, *Proceedings of ESAT 2021-31st European Symposium on Applied Thermodynamics*, 164, 2021, Pariz, Francuska i virtualno okruženje
- Basan, R.; Marohnić, T., On the applicability of cyclic and fatigue parameters estimation methods to high strength steels, *6th International Virtual Conference of Engineering Against Failure ICEAF VI, E-Book of Abstracts*, 203, 2021, Virtualno okruženje
- Troha, S.; Stefanović-Marinović, J.; Vrcan, Ž., Basic Kinematic Characteristics of Two-Speed Planetary Gear Trains with Brakes on Single Shafts, *5th International Conference "Mechanical Engineering in XXI CENTURY"*, MASING 2020978-86-6055-139-1, 171 - 174, 2020, Virtualno okruženje
- Stefanović-Marinović, J.; Vrcan, Ž.; Troha, S., Application of Reversing Output Dual Brake Planetary Transmissions, *19th Scientific-Expert Conference on Railways, RAILCON 2020*, 978-86-6055-134-6, 101 - 104, 2020, Virtualno okruženje
- Stefanović-Marinović, J.; Troha, S.; Vrcan, Ž.; Marković, K.; Šoljić, A., Gears Replacement of Minuteman Cover Drive Planetary Gear Train, *15th International Conference on Accomplishments in Mechanical and Industrial Engineering, DEMI 2021*, 978-99938-39-92-7, 271 - 275, 2021, Virtualno okruženje
- Alisomanova, A.; Troha, S.; Karaivanov, D., A hoisting mechanism of clamshell cranes with a planetary gear train, *18th International Scientific Congress - Machines. Technologies. Materials.*, 2535-003X, 144 - 148, 2021, Virtualno okruženje
- Troha, S.; Karaivanov, D.; Vrcan, Ž.; Marković, K.; Šoljić, A., Coupled two-carrier planetary gearboxes for two-speed drives, *18th International Scientific Congress - Machines. Technologies. Materials.*, 2535-003X, 149 - 155, 2021, Virtualno okruženje
- Ivaničić, D.; Marohnić, T.; Basan, R., Application of digital image correlation method for verification of topology optimization of 3D printed load-bearing element, *5th International Conference on Structural Integrity and Durability ICSID 2021*, 2021, Dubrovnik, Hrvatska i virtualno okruženje



- *Basan, R.; Marohnić, T.; Božić, Ž., Application of material fatigue parameters estimation in analysis of rolling-sliding contact fatigue of gears, 5th International Conference on Structural Integrity and Durability ICSID 2021, 2021, Dubrovnik, Hrvatska i virtualno okruženje*
- *Liović, D.; Franulović, M.; Kozak, D., The effect of process parameters on mechanical behaviour of selective laser melted Ti6Al4V alloy, 5th International Conference on Structural Integrity and Durability ICSID 2021, 2021, "Dubrovnik, Hrvatska i virtualno okruženje"*
- *Dundović, M.; Marković, K.; Franulović, M.; Vrcan, Ž., Dynamic photoelastic study of flexure hinges produced by additive manufacturing technology, 5th International Conference on Structural Integrity and Durability ICSID 2021, 2021*
- *Bazina, T.; Kamenar, E.; Zelenika, S.; Schnurrer Luke Vrbanić, T.; Škifić, A.; Zenzerović, J., Structured open-source procedure for the design and validation of an arm rehabilitation device, 16th Virtual Congress of European Forum for Research in Rehabilitation, 81, 2021, Ljubljana, Slovenija i virtualno okruženje*
- *Bazina, T.; Kamenar, E.; Vrcan, Ž.; Perčić, M.; Zelenika, S.; Čučić, B.; Ilijašević, M., Characterisation of the dynamical behaviour of a power transformer's tank Proceedings of the 37th Danubia Adria Symposium, 23-24, 2021, Linz, Austrija*
- *Kozak, D.; Monkova, K.; Damjanović, D.; Franulović, M.; Józwick, J.; Pisačić, K., Experimental and numerical analysis of printed lattice structure, Proceedings book 19th international foundrymen Conference, 978-953-7082-39-0, 51-65, 2021, Split, Hrvatska*
- *Kozak, D.; Monkova, K.; Franulović, M.; Damjanović, D.; Monka, M.; Turk, D.; Liović, D., Finite element analysis of ABS printed lattice structure, 26th International Conference on Fracture and Structural Integrity IGF26, 2021, Virtualno okruženje*
- *Zaidi, R.; Kozak, D.; Sedmak, A.; Kirin, S.; Franulović, M., Risk assessment based on analytical evaluation of structural integrity of drilling rig welded pipe, 26th International Conference on Fracture and Structural Integrity IGF26, 2021, Virtualno okruženje*
- *Liović, D.; Franulović, M.; Kozak, D., Influence of selective laser melting process parameters on mechanical properties of Ti6Al4V alloy, 5th My First Conference, 2021, Rijeka, Hrvatska*
- *Dundović, M.; Marković, K.; Franulović, M.; Vrcan, Ž., Photoelastic Observations of Corner-Filletted Flexure Hinges Produced by Digital Light Processing Additive Technology, 5th My First Conference, 2021*
- *Franulović, M.; Marković, K., Material Model Calibration for Nonlinear Material Behavior, 14th International conference on advanced computational engineering and experimenting - ACE-X 2021, 2021*

#### POZVANA PREDAVANJA | INVITED LECTURES

- *Basan, R., Conventional methods and machine learning-based models for estimation of materials fatigue parameters and behavior, The 5th International Conference on Structural Integrity and Durability, ICSID 2021, 2021, Dubrovnik, Croatia*
- *Basan, R., Materials parameters determination and fatigue behavior modeling, Summer School on Fatigue and Fracture Modeling and Analysis - The 5th International Conference on Structural Integrity and Durability, ICSID 2021), 2021, Dubrovnik, Croatia*

#### MEDUNARODNA SURADNJA | INTERNATIONAL COLLABORATIONS

- *Elettra, Italija, Italy*
- *Faculty of Industrial Technology, Technical University - Sofia, Bugarska, Bulgaria*

- *Faculty of Mechanical Engineering, Technical University - Sofia, Bugarska, Bulgaria*
- *Fakulteta za strojništvo, Univerza v Ljubljani, Slovenija, Slovenia*
- *Fakulteta za strojništvo, Univerza v Mariboru, Slovenija, Slovenia*
- *Mašinski fakultet, Univerzitet u Nišu, Srbija, Serbia*
- *University of Applied Sciences, Graz, Austrija, Austria*
- *University of Chemical Technology and Metallurgy, Bugarska, Bulgaria*
- *University of Udine, Italija, Italy*
- *Moscow State Industrial University, Rusija, Russia*
- *Institut für Stahlbau und Werkstoffmechanik, Technische Universität Darmstadt, Njemačka, Germany*
- *Czech Technical University in Prague, Češka Republika, Czech Republic*
- *Brno University of Technology, Češka Republika, Czech Republic*
- *Politecnico di Torino, Italija, Italy*
- *University of Trieste, Italija, Italy*
- *Istituto Officina dei Materiali (IOM) of the Italian National Research Council (CNR), Italija, Italy*
- *Mid Sweden University, Švedska, Sweden*
- *University of California Santa Barbara, Department of Mechanical Engineering, Kalifornija, SAD, CA, USA*
- *Royal Institute of Technology, Švedska, Sweden*
- *University of Ferrara, Italija, Italy*



5<sup>6</sup>

ZAVOD ZA MATEMATIKU,  
FIZIKU I STRANE JEZIKE

DEPARTMENT OF MATHEMATICS,  
PHYSICS AND FOREIGN LANGUAGES

## DJELATNICI

### FACULTY AND STAFF

#### PREDSTOJNICA ZAVODA | DEPARTMENT HEAD:



Prof. dr. sc. / Prof. D. Sc. **Nelida Črnjarić-Žic**

*numerička matematika; znanstveno računanje; računalne simulacije u tehnici; matematičko modeliranje; analiza podataka; dinamički sustavi*  
*numerical mathematics; scientific computing; computer simulations in engineering; mathematical modelling; data analysis*

#### DOCENTI | ASSISTANT PROFESSORS



**Ivan Dražić**

*parcijalne diferencijalne jednačbe; mikropolarni fluidi; numerička analiza; statistička obrada podataka; metodika nastave matematike*  
*partial differential equations; micropolar fluids; numerical analysis; statistical analysis; methodology of teaching mathematics*



**Loredana Simčić**

*mikropolarni fluidi; kombinatorna i diskretna matematika*  
*micropolar fluids; combinatorial and discrete mathematics*



**Tomislav Žic**

*fizika; astrofizika; fizika Sunca; magnetohidrodinamika (MHD); numeričko MHD modeliranje; koronini izbačaji mase; svemirska prognostika; modeliranje udarnih valovova u Sunčevoj atmosferi, koroni i međuplanetarnom prostoru*  
*physics; solar physics; magnetohydrodynamics (MHD); numerical MHD modelling; coronal mass ejections; space weather; shock waves modelling in solar atmosphere, corona and interplanetary space*

#### VIŠI PREDAVAČI | SENIOR LECTURERS



**Melita Štefan Trubić**

*numerička matematika; metodika nastave matematike*  
*numerical mathematics; methodology of teaching mathematics*

**Elisa Velčić Janjetić**  
*njemački jezik i književnost; engleski jezik i književnost; jezik struke*  
*german language and literature; english language and literature; professional language*



#### PREDAVAČI | LECTURERS

**Anita Badurina Filipin**  
*njemački jezik i književnost; engleski jezik i književnost; jezik struke*  
*german language and literature; english language and literature; professional language*



**Vanja Čotić Poturić**  
*matematika*  
*mathematics*



**Igor Lulić**  
*matematika*  
*mathematics*



#### ASISTENTI | ASSISTANTS

**Angela Bašić - Šiško**  
*mikropolarni fluidi; numerička matematika*  
*micropolar fluids; numerical mathematics*



**Valentino Marković**  
*primjenjena matematika*  
*applied mathematics*



#### PROFESOR EMERITUS | PROFESSOR EMERITUS

**Julijan Dobrinić**  
*fizika; zaštita okoliša*  
*physics; environmental protection*



## VANJSKI SURADNICI | ASSOCIATES

## Marija Čargonja

Odjel za fiziku Sveučilišta u Rijeci  
| Department of Physics, University of Rijeka

## Patricija Nikolaus

Gimnazija Andrije Mohorovičića Rijeka

## Vesko Nikolaus

Agencija za odgoj i obrazovanje

## fizika

physics

## Dora Kunović

Gimnazija Eugena Kumičića Opatija

## engleski jezik i književnost

english language and literature

## Senka Maćešić

Sveučilište u Rijeci | University of Rijeka

## Sara Ban

Odjel za matematiku Sveučilišta u Rijeci  
| Department of Mathematics, University of Rijeka

## Ana Grbac

Odjel za matematiku Sveučilišta u Rijeci  
| Department of Mathematics, University of Rijeka

## Emma Šepić

Odjel za matematiku Sveučilišta u Rijeci  
| Department of Mathematics, University of Rijeka

## Matteo Mravić

Odjel za matematiku Sveučilišta u Rijeci  
| Department of Mathematics, University of Rijeka

## Bojan Ostić

Odjel za matematiku Sveučilišta u Rijeci  
| Department of Mathematics, University of Rijeka

## Ana Šumberac

Odjel za matematiku Sveučilišta u Rijeci  
| Department of Mathematics, University of Rijeka

## matematika

mathematics

## NASTAVA I ZNANOST

### EDUCATION AND SCIENCE

Nastava matematičkih kolegija izvodi se za inženjere s odabranim poglavljima iz područja lineare algebre, matematičke analize, diferencijalnih jednadžbi, vjerojatnosti i statistike te numeričke i stohastičke matematike. Nastava fizikalnih kolegija izvodi se za inženjere s odabranim poglavljima iz moderne fizike i zaštite okoliša. Nastava engleskog i njemačkog jezika obuhvaća obrađivanje odabranih poglavlja iz područja strojarstva, brodogradnje, elektrotehnike i računarstva te usavršavanje stručnog vokabulara i gramatičkih struktura jezika tehnike.

Mathematical lectures for engineers with selected chapters in the fields of: linear algebra, mathematical analysis, differential equations, probability and statistics, numerical and stochastic mathematics. Physics lectures for engineers with selected chapters in modern physics and environment protection. The English and German Language courses of study cover the analysis of selected chapters in the field of Mechanical Engineering, Naval Architecture, Electrical Engineering and Computer Science as well as the enhancement of professional-technical vocabulary and grammar.

## KOLEGIJI NA PREDDIPLOMSKIM SVEUČILIŠNIM STUDIJIMA

| UNDERGRADUATE UNIVERSITY COURSES

- Matematika 1
- Matematika 2
- Inženjerska matematika ET
- Inženjerska statistika
- Inženjerska matematika R
- Uvod u modernu fiziku
- Fizika 1
- Fizika 2
- Engleski jezik I
- Engleski jezik II
- Njemački jezik I
- Njemački jezik II

- Mathematics 1
- Mathematics 2
- Engineering mathematics ET
- Statistics for engineers
- Engineering mathematics R
- Introduction to modern physics
- Physics 1
- Physics 2
- English Language I
- English Language II
- German Language I
- German Language II

## KOLEGIJI NA DIPLOMSKIM SVEUČILIŠNIM STUDIJIMA

| GRADUATE UNIVERSITY COURSES

- Inženjerska matematika
- Numerička i stohastička matematika
- Stohastička matematika
- Engineering mathematics
- Numerical and stochastic mathematics
- Stochastic mathematics

## KOLEGIJI NA PREDDIPLOMSKIM STRUČNIM STUDIJIMA

| UNDERGRADUATE VOCATIONAL COURSES

- Matematika 1
- Matematika 2
- Fizika
- Engleski jezik I
- Engleski jezik II
- Njemački jezik I
- Njemački jezik II
- Mathematics 1
- Mathematics 2
- Physics
- English Language I
- English Language II
- German Language I
- German Language II

## KOLEGIJI NA POSLIJEDIPLOMSKIM (DOKTORSKIM) SVEUČILIŠNIM STUDIJIMA

| POSTGRADUATE UNIVERSITY (DOCTORAL) COURSES

- Statističke metode i stohastički procesi
- Matematičko modeliranje i numeričke metode
- Metode optimizacije
- Izabrana poglavlja iz zaštite okoliša
- Instrumentacija i analitičke tehnike u zaštiti okoliša
- Kemija okoliša
- Zaštita mora i priobalja
- Statistical Methods and Stochastic Processes
- Mathematical Modeling and Numerical Methods
- Optimization Methods
- Selected Topics on Environment Protection
- Instrumentation and Analytical Techniques in Environment Protection
- Environmental Chemistry
- Protection of Sea and Coastal Zone

## ZNANSTVENOISTRAŽIVAČKI RAD | SCIENTIFIC RESEARCH

- parcijalne diferencijalne jednadžbe, numerička matematika, matematičko modeliranje, optimizacija, operacijska istraživanja, statističke metode, kombinatorna i diskretna matematika, dinamički sustavi, didaktika nastave matematike  
partial differential equations, numerical mathematics, mathematical modeling, optimization, operational research, statistical methods, combinatorial and discrete mathematics, dynamical systems, didactic of mathematics
- zaštita okoliša, atomska i nuklearna fizika  
environment protection, atomic and nuclear physics
- njemački i engleski jezik kao jezik struke; istraživanje uvjeta za implementaciju engleskoga jezika kao jezika poučavanja u visokom školstvu  
German and English as languages for specific purposes (LSP), the study of the conditions for the implementation of English-medium Instruction (EMI) in higher education
- astrofizika, fizika Sunca: magnetohidrodinamika (MHD); numeričko modeliranje  
astrophysics, solar physics; magnetohydrodynamics (MHD); numerical modelling

## PROJEKTI | PROJECTS

- Analiza matematičkih modela mehanike fluida i tehničkih sustava pomoću podacima vođenih algoritama za Koopmanov operator", istraživanje uz potporu Sveučilišta u Rijeci, voditeljica Nelida Črnjarić-Žic, suradnici Senka Maćešić, Ivan Dražić, Loredana Simčić, Angela Bašić-Šiško  
Analysis of mathematical models of fluid mechanics and technical systems using data-driven algorithms for Koopman operator", research supported by the University of Rijeka, principal investigator Nelida Črnjarić-Žic, collaborators Senka Maćešić, Ivan Dražić, Loredana Simčić, Angela Bašić-Šiško

- *Višeskalni problemi u mehanici fluida, projekt HRZZ-a, voditelj prof. Igor Pažanin, PMF - matematički odsjek Sveučilišta u Zagrebu, suradnik Ivan Dražić*  
*Multiscale problems in fluid mechanics", HRZZ project, principal investigator prof. Igor Pažanin, PMF - mathematical department University of Zagreb, collaborator Ivan Dražić*

## PUBLIKACIJE | PUBLICATIONS

## RADovi U ČASOPISIMA | JOURNAL PAPERS

- *Kamenar E.; Črnjarić-Žic N.; Haggerty D.; Zelenika S.; Hawkes E. W.; Mezić, I., Prediction of the behavior of a pneumatic soft robot based on Koopman operator theory, Proceedings of the 43rd Mipro International Convention, 1847-3946, 1417-1421, 2020*
- *Bašić-Šiško, A.; Dražić, I., Uniqueness of generalized solution to micropolar viscous real gas flow with homogeneous boundary conditions, Mathematical methods in the applied sciences, 0170-4214, 44 (6), 4330-4341, 2021*
- *Bašić-Šiško, A.; Dražić, I., Global solution to a one-dimensional model of viscous and heat-conducting micropolar real gas flow, Journal of mathematical analysis and applications, 0022-247X, 495 (1), 1-26, 2021*
- *Kučan M.; Lulić I.; Mršić Pelčić J.; Mozetič V.; Vitezić D., Cost effectiveness of antihypertensive drugs and treatment guidelines, European Journal of Clinical Pharmacology, 1432-1041, 10.1007/s00228-021-03163-4, 1-8, 2021*

## MEĐUNARODNI KONGRESI | INTERNATIONAL CONGRESSES

- *Kamenar E.; Črnjarić-Žic N.; Haggerty D.; Zelenika S.; Hawkes E. W.; Mezić, I., Prediction of the behavior of a pneumatic soft robot based on Koopman operator theory, MIPRO 2020, 2020, Opatija, Hrvatska*
- *Velčić Janjetić, E.; Badurina Filipin, A., Motivierende Unterrichtsmaterialien für Deutsch als Fachfremdsprache, 2nd International Conference of the Slovene Association of LSP teachers, online, 2020, Ljubljana, Slovenia*
- *Bašić-Šiško, A., One-dimensional Dimensionless Model of the Viscous and Heat-conducting Micropolar Real Gas Flow, ICNAAM 2021, 2021, Rodos, Grčka*
- *Dražić, I., Existence result on the shear flow problem for compressible viscous and heat conducting micropolar fluid, ICNAAM 2021, 2021, Rodos, Grčka*
- *Čotić Poturić V.; Dražić I., Does online learning make a difference in students' grades? The 8 th International Scientific Colloquium MATHEMATICS AND CHILDREN, 2021, Osijek, Hrvatska*

## POZVANA PREDAVANJA | INVITED LECTURES

- *Črnjarić-Žic N.; Maćešić S., The Application of Koopman Operator-based Algorithms to Nonautonomous and Stochastic Systems, Seminar in Koopman Methods in Classical and Classical-Quantum Mechanics (Wilhelm und Else Heraeus Stiftung), 2021., online, Njemačka*

## MEĐUNARODNA SURADNJA | INTERNATIONAL COLLABORATIONS

- *University of California, Santa Barbara, SAD, USA*





## PROFESOR EMERITUS | PROFESSOR EMERITUS

Ivan Katavić



*materijali; tehnologija materijala; materijali i tehnološki postupci; metalni materijali; ljevarstvo; karakterizacija materijala; ispitivanje materijala*  
*materials; technology of material; materials and technological processes; metallic materials; casting; materials characterisation; materials testing*

## VANJSKI SURADNICI | ASSOCIATES

Wojciech Sitek

Silesian University of Technology, Gliwice

*materijali; tehnologija materijala; materijali i tehnološki postupci; metalni materijali; nemetalni materijali; karakterizacija materijala; toplinska obrada i inženjerstvo površina; ispitivanje materijala*  
*materials; technology of material; materials and technological processes; metallic materials; nonmetal materials; materials characterisation; heat treatment and surface engineering; materials testing*

Ladislav Vrsalović

Kemijско-tehnološki fakultet u Splitu

| Faculty of Chemistry and Technology, Split

*kemija materijala; elektrokemija; korozija materijala; zaštita materijala*

*chemistry of materials; electrochemistry; materials corrosion; materials protection*

Domagoj Rubeša

FH JOANNEUM, University of Applied Sciences, Graz

*mehanika materijala; mehanika prijeloma i umorljivost; selekcija materijala; procesi oštećivanja materijala*

*materials mechanics; fracture mechanics and fatigue of materials; materials selection; processes of damaging of materials*

Neven Tomašić

RENETEH Ogulin d.o.o.

*materijali; tehnologija materijala; materijali i tehnološki postupci; postupci toplinske obrade; metalni materijali*

*materials; technology of material; materials and technological processes; processes of heat treatment; metallic materials*

*Nastava se izvodi iz područja materijala, tehnologije materijala, materijala i tehnoloških postupaka, karakterizacije materijala, metalnih materijala, nemetalnih materijala, zaštite materijala, mehaničkog ponašanja i odabira materijala, termalnih procesa materijala, ispitivanja materijala i analize loma, procesa oštećivanja materijala, kemije materijala, korozije i zaštite metala.*

## NASTAVA I ZNANOST

### EDUCATION AND SCIENCE

*Lectures in the field of materials, technology of materials, materials and technological processes, materials characterisation, metallic materials, nonmetal materials, materials protection, mechanical behaviour and selection of materials, thermal processes of materials, materials testing and fracture analysis, processes of damaging of materials, materials chemistry, corrosion and metals protection.*

## DJELATNICI

### FACULTY AND STAFF

## PREDSTOJNIK ZAVODA | DEPARTMENT HEAD:

Izv. prof. dr. sc. / Assoc. Prof. D. Sc. **Dario Iljkić**

*materijali; tehnologija materijala; materijali i tehnološki postupci; postupci toplinske obrade; metalni materijali; ljevarstvo; ispitivanje materijala i analiza loma*

*materials; technology of material; materials and technological processes; processes of heat treatment; metallic materials; casting; materials testing and fracture analysis*

## DOCENTI | ASSISTANT PROFESSORS

**Matej Fonović**

*inženjerstvo materijala; inženjerstvo površina; karakterizacija materijala; fizička metalurgija*

*materials engineering; surface engineering; materials characterization; physical metallurgy*

**Sunčana Smokvina Hanza**

*materijali; tehnologija materijala; postupci toplinske obrade; materijali i tehnološki postupci; ispitivanje materijala i analiza loma; karakterizacija materijala; zaštita materijala*

*materials; technology of material; processes of heat treatment; materials and technological processes; materials testing and fracture analysis; materials characterisation; materials protection*

## ASISTENTI | ASSISTANTS

**Lovro Liverić**

*materijali; tehnologija materijala; postupci toplinske obrade; materijali i tehnološki postupci*

*materials; technology of material; processes of heat treatment; materials and technological processes*

**Lovro Štic**

*materijali; tehnologija materijala; postupci toplinske obrade; materijali i tehnološki postupci; zaštita materijala; ispitivanje materijala*

*materials; technology of material; processes of heat treatment; materials and technological processes; materials protection*

**KOLEGIJI NA PREDDIPLOMSKIM SVEUČILIŠNIM STUDIJIMA**

| UNDERGRADUATE UNIVERSITY COURSES

- |                                   |                                   |
|-----------------------------------|-----------------------------------|
| • Materijali I                    | • Materials I                     |
| • Materijali II                   | • Materials II                    |
| • Tehnologija materijala          | • Technology of Material          |
| • Izborni projekt - Materijali I  | • Elective project - Materials I  |
| • Izborni projekt - Materijali II | • Elective project - Materials II |
| • Karakterizacija materijala      | • Materials Characterisation      |
| • Postupci toplinske obrade       | • Processes of Heat Treatment     |

**KOLEGIJI NA DIPLOMSKIM SVEUČILIŠNIM STUDIJIMA**

| GRADUATE UNIVERSITY COURSES

- |  |   |
|--|---|
| • Metalni materijali                       | • Metallic Materials                              |
| • Nemetalni materijali                     | • Nonmetallic Materials                           |
| • Zaštita materijala                       | • Materials Protection                            |
| • Projekt I - Zaštita materijala           | • Project I - Materials Protection                |
| • Projekt I - Metalni materijali           | • Project I - Metallic Materials                  |
| • Ispitivanje materijala i analiza loma    | • Materials Testing and Fracture Analysis         |
| • Termalni procesi materijala              | • Thermal Processes of Materials                  |
| • Projekt II - Termalni procesi materijala | • Project II - Thermal Processes of Materials     |
| • Mehaničko ponašanje i odabir materijala  | • Mechanical Behaviour and Selection of Materials |

**KOLEGIJI NA PREDDIPLOMSKIM STRUČNIM STUDIJIMA**

| UNDERGRADUATE VOCATIONAL COURSES

- |                                    |   |
|------------------------------------|---|
| • Materijali                       | • Materials                             |
| • Materijali i tehnološki postupci | • Materials and Technological Processes |

**KOLEGIJI NA POSLIJEDIPLOMSKIM (DOKTORSKIM) SVEUČILIŠNIM STUDIJIMA**

| POSTGRADUATE UNIVERSITY (DOCTORAL) COURSES

- |  |   |
|--|---|
| • Procesi oštećivanja materijala           | • Processes of Damaging of Materials          |
| • Mehanika prijeloma i umorljivost         | • Fracture Mechanics and Fatigue of Materials |
| • Korozija i zaštita od korozije           | • Corrosion and Corrosion Protection          |
| • Toplinska obrada i inženjerstvo površina | • Heat Treatment and Surface Engineering      |
| • Ispitivanje materijala                   | • Materials Testing                           |

**ZNANSTVENOISTRAŽIVAČKI RAD | SCIENTIFIC RESEARCH**

- Znanstvenoistraživački rad iz znanstvenog područja tehničke znanosti, znanstvenih polja strojarstvo i temeljne tehničke znanosti, znanstvenih grana proizvodno strojarstvo i materijali. *Research and development activities in the scientific area of Technical Sciences, scientific fields of Mechanical Engineering and Fundamental Engineering Sciences, scientific branches of Mechanical Production Engineering and Materials*

**PROJEKTI | PROJECTS**

- Razvoj modela za procjenu ponašanja materijala temeljenih na strojnom učenju, HRZZ projekt, voditelj Robert Basan  
*Development of machine learning-based models for materials behavior estimation (MADEIRA); HRZZ project, principal investigator Robert Basan*
- Istraživanje i razvoj prediktivnih modela ponašanja konstrukcijskih materijala temeljenih na metodama strojnog učenja, potpore znanstvenim istraživanjima na Sveučilištu u Rijeci, voditelj Robert Basan, 2018-2021  
*Research and development of machine learning-based predictive models of design relevant materials, Support for Research at the University of Rijeka, principal investigator Robert Basan, 2018-2021*

- Istraživanje alternativnih tehnika hlađenja-podmazivanja za održivu strojnu obradu teško obradivih materijala, uniri-tehnic-18-293, istraživačka potpora Sveučilišta u Rijeci, Goran Cukor, 2018.-2021., znanstvenoistraživački projekt  
*Investigation of alternative cooling-lubrication techniques for sustainable machining of difficult to cut materials, uniri-tehnic-18-293, University of Rijeka, Goran Cukor, 2018-2021, research and scientific project*

**PUBLIKACIJE | PUBLICATIONS****RADOVI U ČASOPISIMA | JOURNAL PAPERS**

- Smoljan, B.; Iljkić, D.; Smokvina Hanza, S.; Hajdek, K., *Mathematical Modelling of Isothermal Decomposition of Austenite in Steel Metals*, 2075-4701, 11(8), 1292, 2021, Basel, Švicarska
- Smokvina Hanza, S.; Marohnić, T.; Iljkić, D.; Basan, R., *Artificial Neural Networks-Based Prediction of Hardness of Low-Alloy Steels Using Specific Jominy Distance*, *Metals*, 2075-4701, 11(5) 714, 2021, Basel, Švicarska
- Smokvina Hanza, S.; Štic, L.; Liverić, L.; Špada, V., *Corrosion behaviour of tempered 42CrMo4 steel*, *Materiali in tehnologije*, 1580-2949, 55(3), 427-433, 2021, Ljubljana, Slovenija
- Smokvina Hanza, S.; Vrsalović, L.; Štic, L.; Liverić, L., *Corrosion investigations of Al-Si casting alloys in 0.6 M NaCl solution*, *Engineering Review*, 1330-9587, 41(3), 1-9, 2021, Hrvatska
- Smokvina Hanza, S.; Smoljan, B.; Štic, L.; Hajdek, K., *Prediction of Microstructure Constituents' Hardness after the Isothermal Decomposition of Austenite*, *Metals*, 2075-4701, 11(2), 180, 2021, Basel, Švicarska
- Batelić, J.; Špada, V.; Liverić, L.; Martinez, S., *Investigation Of Pipeline Failure In A Thermal Power Plant's Process Wastewater Distribution System*, *Materiali in tehnologije*, 1580-2949, 55(1), 135-140, 2021, Ljubljana, Slovenija

**MEĐUNARODNI KONGRESI | INTERNATIONAL CONGRESSES**

- Iljkić, D.; Smokvina Hanza, S.; Smoljan, B.; Pomenić, .; Štic, .; Liverić, L., *Load capacity and corrosion behavior of quenched and tempered steel 42CrMo4 and cast steel GS- 42CrMo4 Proceedings of International Foundrymen Conference - Humans - Valuable Resource for Foundry Industry Development*, 978-953-7082-39-0, 16-26, 2021., Split
- Smoljan, B.; Iljkić, D.; Hajdek, K.; Sitek, W., *Computer Simulation of Thermal Processing of Steel IOP Conf. Ser. Materials Science and Engineering*, 1757-8981, 916, 1-10, 2020., Eforie Nord

**POZVANA PREDAVANJA | INVITED LECTURES**

- Iljkić, D., *Load capacity and corrosion behavior of quenched and tempered steel 42CrMo4 and cast steel GS- 42CrMo4, Foundrymen Conference - Humans - Valuable Resource for Foundry Industry Development*, 2021., Split, Hrvatska

**MAĐUNARODNA SURADNJA | INTERNATIONAL COLLABORATIONS**

- Faculty of Mechanical Engineering, University of Ljubljana, Ljubljana, Slovenija, Slovenia
- Institute of Metals and Technology, Ljubljana, Slovenija, Slovenia
- John von Neumann Faculty of Informatics, Obuda University, Mađarska, Hungary
- Materials Engineering, Silesian University of Technology in Gliwice, Gliwice, Poljska, Poland



5<sup>8</sup>

ZAVOD ZA MEHANIKU FLUIDA I  
RAČUNARSKO INŽENJERSTVO

DEPARTMENT OF FLUID MECHANICS AND  
COMPUTATIONAL ENGINEERING





## DJELATNICI FACULTY AND STAFF

### PREDSTOJNIK ZAVODA | DEPARTMENT HEAD:



Prof. dr. sc. / Prof. D. Sc. **Lado Kranjčević**

*strujanje u mreži cjevovoda; strujanje u otvorenim vodotocima; paralelno programiranje*  
pipe network flow; open channel flow; parallel programming

### REDOVITI PROFESORI | PROFESSORS



214



**Zoran Čarija**

*analiza i optimizacija hidrauličkih sustava; analiza i optimizacija strujanja u hidroturbinama; strujanje sa slobodnom površinom*  
hydraulic systems analysis and optimization; hydroturbine flow analysis and optimization; free surface fluid flow



**Siniša Družeta**

*analiza i optimizacija hidrauličkih sustava; strujanje u otvorenim vodotocima; optimizacijske metode*  
hydraulic systems analysis and optimization; open channel flow; optimization methods

### IZVANREDNI PROFESOR | ASSOCIATE PROFESSOR



**Jerko Škifić**

*hidraulički tranzijenti; analiza i optimizacija hidrauličkih sustava; programiranje tehničkih aplikacija*  
hydraulic transients; hydraulic systems analysis and optimization; technical software development

### DOCENT | ASSISTANT PROFESSOR



**Stefan Ivić**

*programiranje tehničkih aplikacija; polaganje cjevovoda; optimizacija*  
technical software development; pipe laying; optimization

### ASISTENTI | ASSISTANTS

**Marta Alvir**

*3D modeliranje u računalnoj mehanici fluida, modeliranje strujanja mora, modeliranje ispusta, okolišno inženjerstvo, strojno učenje*  
3D modelling in CFD, CFD modelling of sea dynamics, effluent modelling, environmental engineering, machine learning



**Luka Grbčić**

*primjena strojnog učenja i umjetne inteligencije u inženjerstvu; računarska dinamika fluida; modeliranje miješanja turbulentnog fluida*  
machine learning and AI applications in engineering; computational fluid dynamics; turbulent fluid mixing modeling



**Ivana Lučin**

*3D modeliranje u računalnoj mehanici fluida; strojno učenje*  
3D modelling in CFD; machine learning



## NASTAVA I ZNANOST EDUCATION AND SCIENCE

*Nastava iz područja: mehanika fluida, hidraulički strojevi, računalne metode, numeričko modeliranje, optimizacija.*

CO: Primjena računarskih metoda

*Lectures in the field of: fluid mechanics, hydraulic machines, computational methods, numerical modeling, optimization.*

LLL: Applied Computational Methods

### KOLEGIJI NA PREDDIPLOMSKIM SVEUČILIŠNIM STUDIJIMA

| UNDERGRADUATE UNIVERSITY COURSES

- Računalne aplikacije u inženjerstvu
- Uvod u računarstvo
- Mehanika fluida
- Računarske metode
- Hidraulički strojevi
- Računalne simulacije u tehnici
- Računarsko inženjerstvo
- Računalna grafika
- Computer Applications in Engineering
- Introduction to Computer Science
- Fluid Mechanics
- Computational Methods
- Hydraulic Machines
- Computer Simulations in Engineering
- Computational Engineering
- Computer Graphics

### KOLEGIJI NA DIPLOMSKIM SVEUČILIŠNIM STUDIJIMA

| GRADUATE UNIVERSITY COURSES

- Analiza sustava i podataka
- Dinamika fluida
- Modeliranje u tehnici
- System and Data Analysis
- Fluid Dynamics
- Models in Engineering

- |  |   |  |  |  |
|--|---|--|--|--|
| • Numeričko modeliranje hidrauličkih strojeva    | • Numerical Modeling of Hydraulic Machines        |  |  |  |
| • Optimizacije u tehnici                         | • Optimization in Technics                        |  |  |  |
| • Primjena paralelnog računanja                  | • Applied Parallel Computing                      |  |  |  |
| • Primjena računalne grafike                     | • Applied Computer Graphics                       |  |  |  |
| • Programiranje tehničkih aplikacija             | • Programming of Technical Applications           |  |  |  |
| • Programiranje: skriptni jezici                 | • Programming: Scripting Languages                |  |  |  |
| • Računarska mehanika fluida                     | • Computational Fluid Dynamics                    |  |  |  |
| • Računarske metode u brodogradnji               | • Computational Methods in Naval Engineering      |  |  |  |
| • Vizualizacija i priprema računalnih simulacija | • Visualisation and Setup of Computer Simulations |  |  |  |

**KOLEGIJI NA PREDDIPLOMSKIM STRUČNIM STUDIJIMA**

| UNDERGRADUATE VOCATIONAL COURSES

- |                           |                         |  |  |  |
|---------------------------|-------------------------|--|--|--|
| • Hidraulički strojevi ST | • Hydraulic Machines ST |  |  |  |
| • Mehanika fluida ST      | • Fluid Mechanics ST    |  |  |  |

**KOLEGIJI NA POSLIJEDIPLOMSKIM SVEUČILIŠNIM (DOKTORSKIM) STUDIJIMA**

| POSTGRADUATE UNIVERSITY (DOCTORAL) COURSES

- |  |   |  |  |  |
|--|---|--|--|--|
| • Dinamika fluida                                  | • Fluid Dynamics                                  |  |  |  |
| • Hidrodinamika turbostrojeva                      | • Hydrodynamics of Turbomachines                  |  |  |  |
| • Turbulentno strujanje                            | • Turbulent Flow                                  |  |  |  |
| • Računarska mehanika fluida                       | • Computational Fluid Mechanics                   |  |  |  |
| • Modeliranje nestacionarnog strujanja u cjevovodu | • Unsteady Pipe Flow Modeling                     |  |  |  |
| • Strujanje slobodnom površinom                    | • Free surface flow                               |  |  |  |
| • Numeričko modeliranje strujanja u okolišu        | • Numerical modelling of environmental flow       |  |  |  |
| • Računalno modeliranje širenja onečišćenja        | • Computational modelling of pollution dispersion |  |  |  |

**ZNANSTVENOISTRAŽIVAČKI RAD | SCIENTIFIC RESEARCH**

- Strujanje u priobalnom području  
Coastal flow
- Strujanje u otvorenim vodotocima  
Open channel flow
- Analiza i optimizacija hidrauličkih sustava  
Hydraulic systems analysis and optimization
- Hidraulički tranzijenti  
Hydraulic transients
- Strujanje u cjevovodima  
Pipe flow
- Optimizacijske metode  
Optimization methods
- Hibridno 2D/3D modeliranje strujanja sa slobodnom površinom  
Hybrid 2D/3D free surface flow modeling
- Predikcija mikrobiološke kakvoće vode upotrebom strojnog učenja  
Microbiological water quality prediction using machine learning
- Algoritmi kontrole više-agentnog pretraživanja  
Multi-agent search control algorithms

**PROJEKTI | PROJECTS**

- EU projekt KLIMOD - Računalni model strujanja, poplavlivanja i širenja onečišćenja u rijekama i obalnim morskim područjima 01/2020-01/2023 (KK.05.1.1.02.0017), voditelj prof.dr.sc. Lado Kranjčević, partnerski konzorcij: Tehnički fakultet Sveučilišta u Rijeci – prijavitelj, Prirodoslovno matematički fakultet – Geološki odsjek – partner, Institut Ruđer Bošković – partner, Medicinski fakultet Rijeka – partner, Građevinski fakultet Rijeka – partner.

EU project KLIMOD - A computational model of flow, flooding and pollution dispersion in rivers and coastal marine areas 01/2020-01/2023 (KK.05.1.1.02.0017), project leader prof. dr. Lado Kranjčević Project consortium: Faculty of Engineering University of Rijeka – lead partner, Faculty of Science - Department of Geology, University of Zagreb UNIZG – partner, Ruđer Bošković Institute – partner, Faculty of Medicine University of Rijeka – partner, Faculty of Civil Engineering University of Rijeka – partner.

- EU projekt EUROCC, National Competence Centres in the Framework of EuroHPC, voditelj projektne komponente na UNIRI/RITEH prof.dr.sc. Lado Kranjčević, partnerski konzorcij: SRCE Zagreb – voditelj projektne komponente u RH, Tehnički fakultet Sveučilišta u Rijeci – partner, Sveučilište u Rijeci – partner, Institut Ruđer Bošković Zagreb – partner, FER Zagreb – partner, FESB Split – partner, FERIT Osijek – partner.

EU project EUROCC, National Competence Centres in the Framework of EuroHPC, UNIRI/RITEH project component leader prof.dr. Lado Kranjčević. Partner consortium: SRCE Zagreb – RH project component leader, Faculty of Engineering UNIRI – partner, UNIRI – partner, Institut Ruđer Bošković Zagreb – partner, FER Zagreb – partner, FESB Split – partner, FERIT Osijek – partner.

- EU projekt HiPowerEd, Digital Empowering Trough HPC Education, voditelj prof.dr.sc. Lado Kranjčević. Projektni konzorcij: Tehnički fakultet Sveučilišta u Rijeci – prijavitelj, Technische universitaet Muenchen – partner, Danmarks tekniske universitet Copenhagen – partner, Università degli studi di Trieste – partner, Visoko učiliste Algebra Zagreb – partner.

EU project HiPowerEd, Digital Empowering Trough HPC Education, project leader prof.dr. Lado Kranjčević. Project consortium: Faculty of Engineering University of Rijeka – lead partner, Technische universitaet Muenchen – partner, Danmarks tekniske universitet Copenhagen – partner, Università degli studi di Trieste – partner, Visoko učiliste Algebra Zagreb – partner.

- Autonomni sustav bespilotnih letjelica za traženje i spašavanje na moru, Hrvatska zaklada za znanost, HRZZ UIP-2020-02-5090, 2021. - 2026.

Autonomous UAV system for oceanic search and rescue, Croatian science foundation, HRZZ UIP-2020-02-5090. 2021. - 2026.

- Interdisciplinarna istraživanja strujanja fluida u makro i mikrosustavima uz primjenu super-računalnih simulacija - projekt uz potporu Sveučilišta, voditelj prof.dr.sc. Zoran Čarija, Tehnički fakultet Sveučilišta u Rijeci, 2019/2020.

Interdisciplinary research of fluid flow in macro and microsystems with the application of supercomputers - pproject supported by University of Rijeka, Faculty of Engineering University of Rijeka, project leader prof. dr. Zoran Čarija, 2020/2021.

- Razvoj hibridnog 2D/3D modela za učinkovito modeliranje strujanja u rijekama, jezerima i morima - projekt uz potporu Sveučilišta, Tehnički fakultet Sveučilišta u Rijeci, voditelj prof. dr. sc. Lado Kranjčević, 2019/2020.

Hybrid 2D/3D model development for efficient flow modelling in rivers, lakes and oceans - project supported by University of Rijeka, Faculty of Engineering University of Rijeka, project leader prof. dr. Lado Kranjčević, 2020/2021.

**PUBLIKACIJE | PUBLICATIONS****RADOVI U ČASOPISIMA | JOURNAL PAPERS**

- Vukić Lušić, D.; Cenov, A.; Lušić, S.; Glad, M.; Jozić, S.; Alvir, M.; Kranjčević, L., Bathing Quality of the Sea in the Primorje-Gorski Kotar County and in the Rijeka Area in the Past Decade, Hrvatske vode, 1330-1144, 29(116), 103-112, 2021, Zagreb, Hrvatska
- Sikirica, A.; Čarija, Z.; Lučin, I.; Grbčić, L.; Kranjčević, L., Cavitation Model Calibration Using Machine Learning Assisted Workflow, Mathematics, 2227-7390, 8(12), 2107, 2020, Basel, Švicarska



- Lučin, I.; Grbčić, L.; Čarija, Z.; Kranjčević, L., *Machine-learning classification of a number of contaminant sources in an urban water network*, *Sensors*, 1424-8220, 21(1), 245, 2021, Basel, Švicarska
- Grbčić, L.; Kranjčević, L.; Družeta, S., *Machine learning and simulation-optimization coupling for water distribution network contamination source detection*, *Sensors*, 1424-8220, 21(4), 1157, 2021, Basel, Švicarska
- Ivić, S.; Crnković, B.; Arbabi, H.; Loire, S.; Clary, P.; Mezić, I., *Search strategy in a complex and dynamic environment: the MH370 case*, *Scientific Reports*, ISSN 2045-2322, Early access (online), 2020, London, Velika Britanija
- Ivić, S.; *Motion Control for Autonomous Heterogeneous Multiagent Area Search in Uncertain Conditions*, *IEEE Transactions on Cybernetics* ISSN 2168-2275, Early access (online), 2020, New York, Sjedinjene Američke Države
- Lučin, I.; Grbčić, L.; Družeta, S.; Čarija, Z.; *Source Contamination Detection Using Novel Search Space Reduction Coupled with Optimization Technique*, *Journal of Water Resources Planning and Management*, 1943-5452, 147(2), 4020100, 2021, Sjedinjene Američke Države
- Lučin, I.; Lučin, B.; Čarija, Z.; Sikirica, A., *Data-Driven Leak Localization in Urban Water Distribution Networks Using Big Data for Random Forest Classifier Mathematics*, 2227-7390, 6 (9), 672, 2021, Basel, Švicarska
- Peršić Bukmir, R.; Paljević, E.; Braut, A.; Sikirica, A.; Čarija, Z.; Brekalo Pršo, I.; Anić, I., *Influence of operator experience on vertical force during instrumentation using Neoniti rotary files* *Giornale Italiano di Endodonzia*, 1121-4171, 35 (1), 10, 2021, Milano, Italija
- Mađerić, D.; Čarija, Z.; Pavković, B.; Delač, B., *Experimental and numerical study on water ice forming on pipe columns in a limited-volume storage*, *Applied Thermal Engineering*, 1359-4311, 194, 117080, 2021



**POZVANA PREDAVANJA | INVITED LECTURES**

- Kranjčević, L., *Hrvatski centar kompetencija za računalstvo visokih performanci - Suradnja s industrijom (Projekt EUROCC)*, *Dani e-Infrastrukture Srce DEI 2021*, 2021, Zagreb, Hrvatska

**MEĐUNARODNA SURADNJA | INTERNATIONAL COLLABORATIONS**

- *Technische Universität München, Ingenieur fakultät Bau Geo Umwelt, Njemačka, Germany*
- *Technical University of Denmark - DTU, Danska, Denmark*
- *University of Southern Denmark, Danska, Denmark*
- *University of Trieste, Italija, Italy*

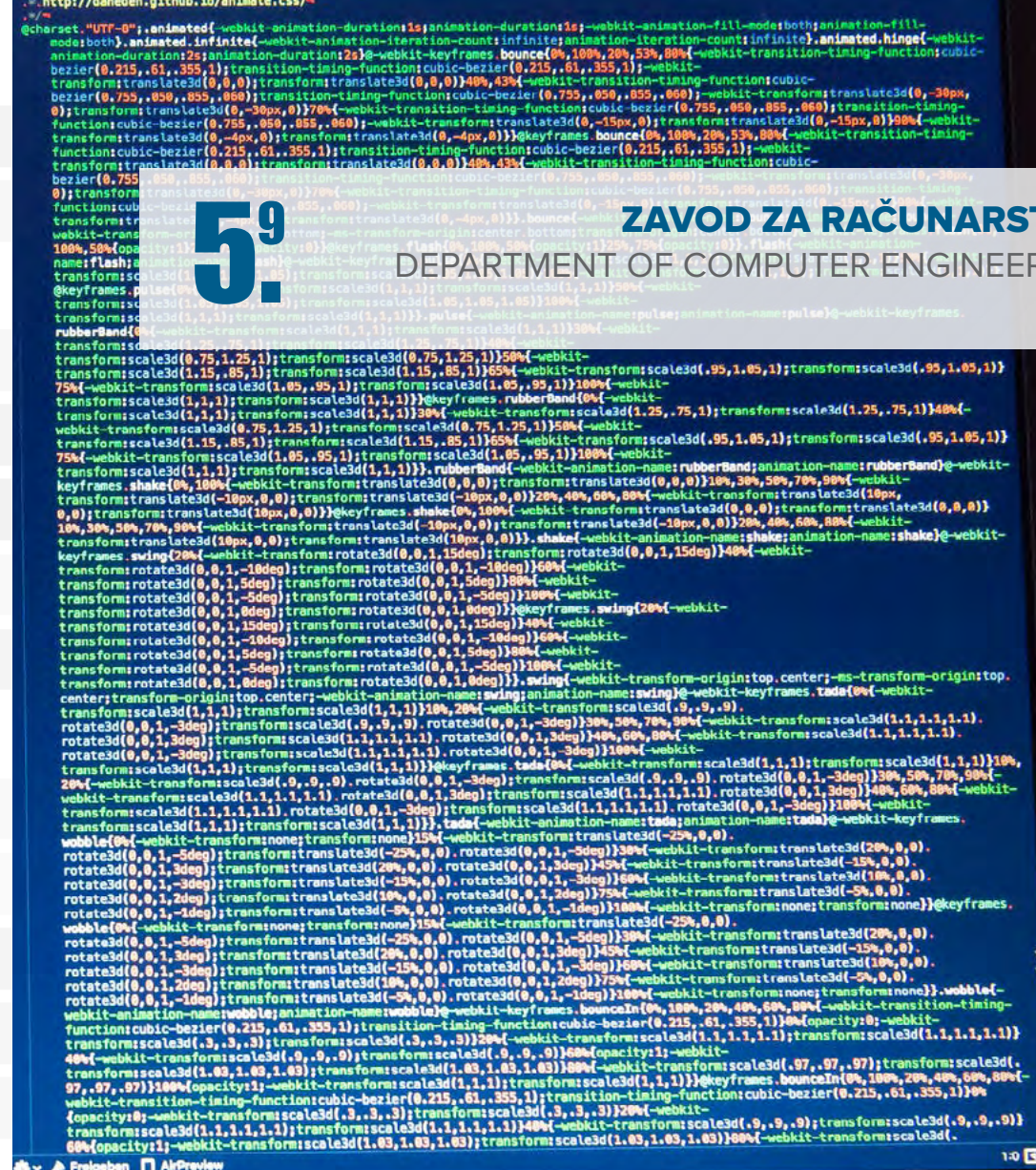

**ZAVOD ZA RAČUNARSTVO**  
DEPARTMENT OF COMPUTER ENGINEERING

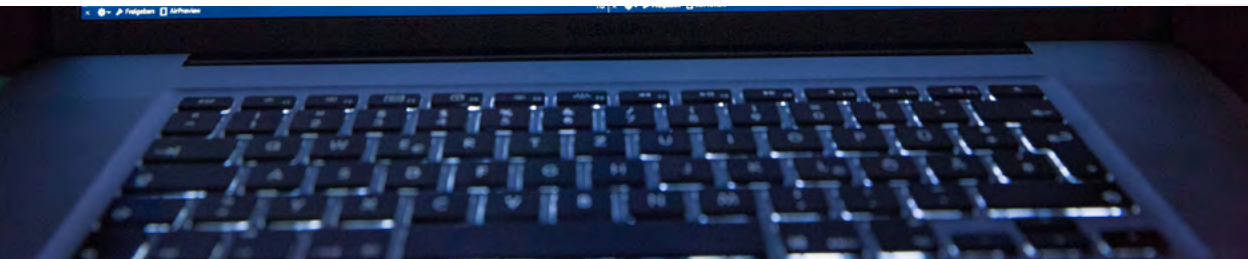

## DJELATNICI FACULTY AND STAFF

### PREDSTOJNIK ZAVODA | DEPARTMENT HEAD:



Doc. dr. sc. / Assist. Prof. D. Sc. **Jonatan Lerga**

*digitalna obrada signala; teorija informacija; kodiranje; kriptografija; umjetna inteligencija*

*digital signal processing; information theory; coding; cryptography; artificial intelligence*

### REDOVITI PROFESOR U TRAJNOM ZVANJU | TENURED PROFESSOR



**Ivo Ipšić**

*umjetna inteligencija; raspoznavanje uzoraka; govorne tehnologije*  
*artificial intelligence; pattern recognition; speech technologies*

### REDOVITI PROFESOR | PROFESSOR



**Miroslav Joler**

*antene; visokofrekvencijska elektronika; bežične komunikacije; računalni elektromagnetizam; rekonfigurabilni sklopovi*  
*antennas; high-frequency electronics; wireless communications; computational electromagnetics; reconfigurable circuits*

### IZVANREDNI PROFESORI | ASSOCIATE PROFESSORS



**Kristijan Lenac**

*mobilna robotika; operacijski sustavi; ugradbeni sustavi; blockchain*  
*mobile robotics; operating systems; embedded systems; blockchain*

### DOCENTI | ASSISTANT PROFESSORS

**Ivan Štajduhar**

*umjetna inteligencija; strojno učenje*  
*artificial intelligence; machine learning*



**Mladen Tomić**

*digitalna obrada signala i slike; teorija valića; filtarski slogovi*  
*digital signal and image processing; wavelets; filter banks*



**Sandi Ljubić**

*interakcija čovjeka i računala; mobilne aplikacije; inženjerstvo upotrebljivosti; empirijsko vrednovanje interaktivnih sustava*  
*human-computer interaction (HCI); mobile applications; usability engineering; interactive systems empirical evaluation*



**Goran Mauša**

*umjetna inteligencija; primijenjeno meko računarstvo; predviđanje programskih neispravnosti; kemija peptida*  
*artificial intelligence; applied soft computing; software defect prediction; peptide chemistry*



### ASISTENTI | ASSISTANTS

**David Bačnar**

*vremensko-frekvencijska analiza signala; digitalna obrada signala*  
*time-frequency signal analysis; digital signal processing*



**Luka Batistić**

*interakcija čovjeka i računala; digitalna obrada signala*  
*human-computer interaction (HCI); digital signal processing*



**Boris Gašparović**

*umjetna inteligencija; obrada slike*  
*artificial intelligence; image processing*



220



221

**Franko Hrzić**

*umjetna inteligencija; strojno učenje*  
artificial intelligence; machine learning

**Marko Njirjak**

*umjetna inteligencija; strojno učenje; evolucijski algoritmi*  
artificial intelligence; machine learning; evolutionary algorithms

**Erik Otović**

*umjetna inteligencija; strojno učenje; evolucijski algoritmi*  
artificial intelligence; machine learning; evolutionary algorithms

**Alen Salkanović**

*interakcija čovjeka i računala; mobilne aplikacije*  
human-computer interaction (HCI); mobile applications

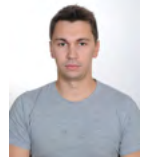
**Denis Selimović**

*digitalna obrada signala;*  
*vremensko-frekvencijska analiza signala*  
digital signal processing;  
time-frequency signal analysis

**Arian Skoki**

*umjetna inteligencija; strojno učenje; znanost u sportu*  
artificial intelligence; machine learning; sport science

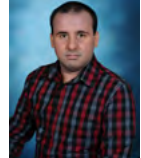
**Diego Sušanj**

*obrada slike; bežične mreže osjetila; ugradbeni sustavi*  
image processing; wireless sensor networks; embedded systems

**Ana Vranković Lacković**

*vremensko-frekvencijska analiza signala; teorija informacija*  
time-frequency signal analysis; information theory

**Domagoj Pinčić**

*obrada slike, strojno učenje*  
image processing, machine learning

**STRUČNI SURADNIK | ASSOCIATE****KOLEGIJI NA PREDDIPLOMSKIM SVEUČILIŠNIM STUDIJIMA**

| UNDERGRADUATE UNIVERSITY COURSES

- *Algoritmi i strukture podataka*
- *Baze podataka*
- *Digitalna logika*
- *Građa računala CO*
- *Operacijski sustavi*
- *Programiranje CO*
- *Programiranje I*
- *Programiranje II*
- *Programska podrška u inženjerstvu*
- *Programsko inženjerstvo*
- *Računalne vještine*
- *Računalne mreže*
- *Razvoj web aplikacija*
- *Ugradbeni računalni sustavi*
- *Uvod u objektno orijentirano programiranje*
- *Uvod u umjetnu inteligenciju*
- *Algorithms and Data Structures*
- *Database Systems*
- *Digital Logic*
- *Computer Architecture LLL*
- *Operating Systems*
- *Programming LLL*
- *Programming I*
- *Programming II*
- *Computer Software in Engineering*
- *Software Engineering*
- *Computing Skills*
- *Computer Networks*
- *Web Applications Development*
- *Embedded Systems*
- *Introduction to Object Oriented Programming*
- *Introduction to Artificial Intelligence*

**KOLEGIJI NA DIPLOMSKIM SVEUČILIŠNIM STUDIJIMA**

| GRADUATE UNIVERSITY COURSES

- *Bežične mreže osjetila*
- *Digitalna obrada slike*
- *Inženjerstvo kompleksnih programskih sustava*
- *Komunikacija čovjek-stroj*
- *Mikrovalno inženjerstvo*
- *Mobilna robotika*
- *Mobilne komunikacije*
- *Napredna korisnička sučelja*
- *Napredni operacijski sustavi*
- *Napredne računalne mreže*
- *Napredni algoritmi i strukture podataka*
- *Objektno orijentirano programiranje*
- *Wireless Sensor Networks*
- *Digital Image Processing*
- *Complex Software Systems Engineering*
- *Human-Machine Interaction*
- *Microwave Engineering*
- *Mobile Robotics*
- *Mobile Communications*
- *Advanced User Interfaces*
- *Advanced Operating Systems*
- *Advanced Computer Networks*
- *Advanced Algorithms and Data Structures*
- *Object Oriented Programming*



- |                                    |   |  |  |  |  |
|------------------------------------|---|--|--|--|--|
| • Programiranje ugradbenih sustava | • Embedded Systems Programming            |  |  |  |  |
| • Programski određen radio         | • Software-Defined Radio                  |  |  |  |  |
| • Računalna obrada govora i jezika | • Computer Speech and Language Processing |  |  |  |  |
| • Strojno učenje                   | • Machine Learning                        |  |  |  |  |
| • Teorija informacija i kodiranje  | • Information Theory and Coding           |  |  |  |  |
| • Ugradbeni računalni sustavi      | • Embedded Systems                        |  |  |  |  |
| • Usluge zasnovane na lokaciji     | • Location-Based Services                 |  |  |  |  |

**KOLEGIJI NA PREDDIPLOMSKIM STRUČNIM STUDIJIMA**

| UNDERGRADUATE VOCATIONAL COURSES

- |                        |                        |  |  |  |  |
|------------------------|------------------------|--|--|--|--|
| • Primjena računala ST | • Applied Computing ST |  |  |  |  |
|------------------------|------------------------|--|--|--|--|

**KOLEGIJI NA POSLIJEDIPLOMSKIM SVEUČILIŠNIM (DOKTORSKIM) STUDIJIMA**

| POSTGRADUATE UNIVERSITY (DOCTORAL) COURSES

- |   |  |  |  |  |  |
|---|--|--|--|--|--|
| • Intelligentni sustavi                                     | • Intelligent Systems                                |  |  |  |  |
| • Nosivo računarstvo  | • Wearable Computing                                 |  |  |  |  |
| • Oblikovanje i vrednovanje naprednih interaktivnih sustava | • Advanced Interactive Systems Design and Evaluation |  |  |  |  |
| • Odabrana poglavlja iz komunikacijskih mreža               | • Selected Chapters from Communication Networks      |  |  |  |  |
| • Primijenjeno strojno učenje                               | • Applied Machine Learning                           |  |  |  |  |
| • Računalna percepcija                                      | • Computer Perception                                |  |  |  |  |
| • Teorija informacija s primjenama                          | • Information Theory with Applications               |  |  |  |  |
| • Uslužna robotika  | • Service Robotics                                   |  |  |  |  |
| • Uvod u meko računarstvo i primjene                        | • Introduction to Soft Computing and Applications    |  |  |  |  |

**ZNANSTVENOISTRAŽIVAČKI RAD | SCIENTIFIC RESEARCH**

- računalna obrada govora i jezika, raspoznavanje uzoraka  
speech processing and pattern recognition
- nosive antene; pametna odjeća; rekonfigurabilni sklopovi  
wearable antennas; smart clothing; reconfigurable circuits
- mobilna robotika, blockchain, ugradbeni sustavi, satelitska navigacija  
mobile robotics, blockchain, embedded systems, satellite navigation
- digitalna obrada signala, teorija informacija, kodiranje, kriptografija, umjetna inteligencija  
digital signal processing, information theory, coding, cryptography, artificial intelligence
- interakcija čovjeka i računala, prediktivno modeliranje i vrednovanje interakcije, inženjerstvo upotrebljivosti, univerzalni pristup  
human-computer interaction, interaction predictive modeling and evaluation, usability engineering, universal access
- primijenjeno meko računarstvo, dubinska analiza podataka, programsko inženjerstvo  
applied soft computing, data mining, software engineering
- strojno učenje, računalom potpomognuto dijagnosticiranje, analiza slike  
machine learning, computer aided diagnosis, image analysis
- digitalna obrada signala, adaptivni valični algoritmi  
digital signal processing, adaptive wavelet algorithms
- obrada slike, bežične mreže osjetila, ugradbeni sustavi  
image processing, wireless sensor networks, embedded systems
- vremensko-frekvencijska analiza signala, informacijske mjere  
time-frequency signal analysis, information measures

- interakcija čovjeka i računala; mobilne aplikacije  
human-computer interaction (hci); mobile applications
- obrada slike, strojno učenje  
image processing, machine learning
- interakcija čovjeka i računala, digitalna obrada signala  
human-computer interaction (hci), digital signal processing
- strojno učenje, računalom potpomognuto dijagnosticiranje  
machine learning, computer aided diagnosis
- vremensko-frekvencijska analiza signala, informacijske mjere  
time-frequency signal analysis, information measures
- umjetna inteligencija, strojno učenje, evolucijski algoritmi  
artificial intelligence, machine learning, evolutionary algorithms
- umjetna inteligencija, strojno učenje, evolucijski algoritmi  
artificial intelligence, machine learning, evolutionary algorithms
- vremensko-frekvencijska analiza signala, digitalna obrada signala  
time-frequency signal analysis, digital signal processing
- umjetna inteligencija, strojno učenje, znanost u sportu  
artificial intelligence, machine learning, sport science
- umjetna inteligencija, obrada slike  
artificial intelligence, digital image processing

**PROJEKTI | PROJECTS**

- Razvoj pametne jakne, Sveučilište u Rijeci, znanstveno-istraživački. Voditelj projekta Joler  
Smart Jacket Development, Funded by: University of Rijeka, Croatia. Scientific research. Principal Investigator Joler
- Prirodna i višemedalna komunikacija čovjek stroj, Znanstveni projekt financiran od strane Sveučilišta u Rijeci. Glavni istraživač Ipšić  
Natural and multimodal man machine communication, A scientific project funded by the University of Rijeka. Principal investigator Ipšić
- CEEPUS mreža "International Cooperation in Computer Science". Lokalni koordinator: J. Lerga.  
CEEPUS network "International Cooperation in Computer Science". Local coordinator: J. Lerga.
- CEEPUS mreža CIII-AT-0042 "Image Processing, Information Engineering & Interdisciplinary Knowledge Exchange". Lokalni koordinator: I. Štajduhar  
CEEPUS network CIII-AT-0042 "Image Processing, Information Engineering & Interdisciplinary Knowledge Exchange". Local coordinator: I. Štajduhar
- DEcision Support System for green and safe ship Routing, Znanstveni projekt financiran od Hrvatske zaklade za znanost. Voditeljica: J. Prpić-Oršić. Suradnik: J. Lerga et al.  
DEcision Support System for green and safe ship Routing, A scientific project funded by the Croatian Science Foundation. Principal investigator: J. Prpić-Oršić. Researchers: J. Lerga et al.
- Computer-Aided Digital Analysis and Classification of Signals, Znanstveni projekt financiran od Sveučilišta u Rijeci. Voditelj projekta: J. Lerga. Suradnici: I. Štajduhar et al.  
Computer-Aided Digital Analysis and Classification of Signals, A scientific project funded by the University of Rijeka. Principal investigator: J. Lerga. Researchers: I. Štajduhar et al.



- **Razvoj postupaka temeljenih na strojnom učenju za prepoznavanje bolesti i ozljeda iz medicinskih slika, Znanstveni projekt financiran od strane Sveučilišta u Rijeci, uniri-tehnic-18-15.** Voditelj projekta: I. Štajduhar. Researchers: J. Lerga, S. Ljubić, D. Miletić, M. Milanić, S. Tschauner, T. Manojlović, F. Hrzić, A. Salkanović, A. Skoki.  
Development of Machine-Learning-Based Techniques for Illness and Injury Detection in Medical Images, A scientific project funded by the University of Rijeka, uniri-tehnic-18-15. Principal investigator: I. Štajduhar. Researchers: J. Lerga, S. Ljubić, D. Miletić, M. Milanić, S. Tschauner, T. Manojlović, F. Hrzić, A. Salkanović, A. Skoki.
- **A Network for Gravitational Waves, Geophysics and Machine Learning, EU COST znanstveni projekt CA17137.** Istraživači: J. Lerga, I. Štajduhar et al.  
A Network for Gravitational Waves, Geophysics and Machine Learning". EU COST scientific project CA17137. Researchers: J. Lerga, I. Štajduhar et al.
- **European Network for assuring food integrity using non-destructive spectral sensors, EU COST znanstveni projekt CA19145.** Istraživači: I. Štajduhar, F. Hrzić et al.  
European Network for assuring food integrity using non-destructive spectral sensors, EU COST scientific project CA19145. Researchers: I. Štajduhar, F. Hrzić et al.
- **Interaktivni tečaj za automatsko upravljanje, Erasmus+ Key Action 2: Cooperation for innovation and the exchange of good practices, 2018-1-SIO1-KA203-047081, 2018-2021.** Voditelj na partnerskoj instituciji: S. Ljubić; Suradnici: A. Salkanović, F. Hrzić, A. Vranković  
Interactive Course for Control Theory, Erasmus+ Key Action 2: Cooperation for innovation and the exchange of good practices, 2018-1-SIO1-KA203-047081, 2018-2021. Head at a partner institution: S. Ljubić; team members: A. Salkanović, F. Hrzić, A. Vranković
- **Sars-CoV-2 supramolekularni mimetici za pronalazak peptida koji induciraju zarobljavanje virusa, UNIRI multidisciplinarni Covid-19 projekt, voditelji projekta: D. Kalafatović i G. Mauša**  
Sars-CoV-2 supramolecular mimetics for discovery of peptides that induce viral entrapment, UNIRI multidisciplinary Covid-19 project, principal investigators: D. Kalafatović and G. Mauša
- **Promocija održivosti kao ključnog pokretača u obrazovanju za razvoj programske podrške, ERASMUS+ projekt (broj 2020-1-PT01-KA203-078646), voditelj na partnerskoj instituciji: Goran Mauša, suradnik: S. Ljubić**  
Promoting Sustainability as a Fundamental Driver in Software development Training and Education, ERASMUS+ project (grant no. 2020-1-PT01-KA203-078646), head at a partner institution: Goran Mauša, team member: S. Ljubić
- **Primjena strojnog učenja za pronalazak katalitički aktivnih peptida, UNIRI-plus projekt razvoja novog istraživačkog smjera, broj uniri-pr-tehnic-19-10, voditelj projekta: G. Mauša**  
Applying Machine Learning for the Discovery of Peptides with Catalytic Activity, UNIRI-plus project for new research directions, grant number uniri-pr-tehnic-19-10, principal investigator: G. Mauša
- **Povezivanje obrazovne i istraživačke zajednice za inovativno društvo osvještano ograničenja resursa, projekt COST akcije Europske Kooperacije u Znanosti i Tehnologiji, broj CA19135, član upravnog odbora: G. Mauša**  
Connecting education and research communities for an innovative resource aware society, COST action project funded by The European Cooperation in Science and Technology, grant no. CA19135, management committee member: G. Mauša
- **Dizajn katalitički aktivnih peptida i peptidnih nanostrukture, uspostavni istraživački projekt Hrvatske Zaklade za Znanost, broj UIP-2019-04-7999, Voditelj projekta: D. Kalafatović, istraživač: G. Mauša**  
Design of short catalytic peptides and peptide assemblies, scientific installation project funded by the Croatian Science Foundation, grant no. UIP-2019-04-7999, principal investigator: D. Kalafatović, researcher: G. Mauša

- **Računalni model strujanja, poplavlivanja i širenja onečišćenja u rijekama i obalnim morskim područjima, istraživački projekt Europskih strukturalnih i investicijskih fondova, broj KK.05.1.1.02.0017, voditelj: L. Kranjčević, istraživač: G. Mauša**  
A computational model of flow, flooding and pollution dispersion in rivers and coastal marine areas, applied research project founded by European structural and investment funds, grant no. KK.05.1.1.02.0017, principal investigator: L. Kranjčević, researcher: G. Mauša
- **Pouzdana i sigurni složeni programski sustavi: od empirijskih principa do teorijskih modela u vidu industrijskih primjena, istraživački projekt Hrvatske Zaklade za Znanost, broj IP-2019-04-4216, Voditelj projekta: T. Galinac Grbac, istraživač: G. Mauša**  
Reliable and Safe Complex Software Systems: From Empirical Principles to Theoretical Models in View of Industrial Applications, scientific project funded by the Croatian Science Foundation, grant no. IP-2019-04-4216, principal investigator: T. Galinac Grbac, researcher: G. Mauša
- **Dig IT - Izrada standarda zanimanja i standarda kvalifikacija u djelatnostima računarstva (UP.03.1.1.03.0061). Stručnjaci: I. Štajduhar, S. Ljubić, G. Mauša.**  
Dig IT - Development of occupational standards and standard of qualifications in computer science (UP.03.1.1.03.0061). Experts: I. Štajduhar, S. Ljubić, G. Mauša.
- **National Competence Centres in the Framework of EuroHPC (EUROCC), Europski Horizon 2020 projekt H2020-JTI-EuroHPC-2019-2. Suradnici: I. Štajduhar, G. Mauša, J. Lerga et al.**  
National Competence Centres in the Framework of EuroHPC (EUROCC), European Horizon 2020 project H2020-JTI-EuroHPC-2019-2. Researchers: I. Štajduhar, G. Mauša, J. Lerga et al.
- **Analiza hiperspektralnih slika korištenjem strojnog učenja i adaptivnog filtriranja prilagođenog podacima, Bilateralni hrvatsko-slovenski projekt. Voditelj: J. Lerga. Suradnici: I. Štajduhar, F. Hrzić, L. Batistić**  
Hyperspectral Image Analysis Using Machine Learning and Adaptive Data-Driven Filtering, Bilateral Croatian-Slovenian project. Principal investigator: J. Lerga. Researchers: I. Štajduhar, F. Hrzić, L. Batistić.
- **DATA-CROSS - Napredne metode i tehnologije u znanosti o podacima i kooperativnim sustavima, Poziv: Vrhunska istraživanja znanstvenih centara izvrsnosti. Referenca: KK.01.1.1.01.0009. Istraživači: K. Lenac, D. Pinčić**  
DATA-CROSS Advanced Methods and Technologies in Data Science and Cooperative Systems, Call: Top-level researches in Centres of Excellence, Reference: KK.01.1.1.01.0009. Researchers: K. Lenac, D. Pinčić
- **Ugradbeni sustavi za 3D percepciju, Referenca: uniri-tehnic-18-295. Voditelj: K. Lenac. Istraživači: M. Tomić, D. Sušan, L. Batistić, D. Pinčić, D. Špoljar**  
Embedded Systems for 3D perception, Reference: uniri-tehnic-18-295. Principal investigator: K. Lenac. Researchers: M. Tomić, D. Sušan, L. Batistić, D. Pinčić, D. Špoljar
- **"ABSistemDCiCloud". Projekt IRI - Povećanje razvoja novih proizvoda i usluga koji proizlaze iz aktivnosti istraživanja i razvoja - faza II, financiran od Europskog fonda za regionalni razvoj. Voditelj: J. Lerga. Suradnik: D. Bačnar**  
ABSistemDCiCloud, IRI project - Increasing the development of new products and services resulting from research and development activities - phase II, funded by the European Regional Development Fund. Principal investigator: J. Lerga. Researcher: D. Bačnar
- **Adria Smart Room, HAMAG-BICRO KK.01.2.1.02.0303. projekt IRI - Povećanje razvoja novih proizvoda i usluga koji proizlaze iz aktivnosti istraživanja i razvoja - faza II, financiran od Europskog fonda za regionalni razvoj. Istraživači: I. Štajduhar, S. Ljubić, I. Wolf, F. Hrzić, A. Salkanović et al.**



Adria Smart Room, HAMAG-BICRO KK.01.2.1.02.0303. IRI project - Increasing the development of new products and services resulting from research and development activities - phase II, funded by the European Regional Development Fund. Researchers: I. Štajduhar, S. Ljubić, I. Wolf, F. Hrzić, A. Salkanović et al.

- **Strojno učenje za prijenos znanja u medicinskoj radiologiji (RadiologyNET)**, Hrvatska zaklada za znanost IP-2020-02-3770. Voditelj: I. Štajduhar. Suradnici: D. Miletić, M. Milanić, G. Glavaš, S. Tschauner, M. M. Saračević, F. Hrzić  
Machine Learning for Knowledge Transfer in Medical Radiology (RadiologyNET), Croatian Science Foundation research project IP-2020-02-3770. Principal investigator: I. Štajduhar. Researchers: D. Miletić, M. Milanić, G. Glavaš, S. Tschauner, M. M. Saračević, F. Hrzić

## PUBLIKACIJE | PUBLICATIONS

### RADOVI U ČASOPISIMA | JOURNAL PAPERS

- Stanković, A.; Lerga, J.; Mandić, D.; Brajović, M.; Richard, C.; Daković, M., *From Time-Frequency to Vertex-Frequency and Back*, *Mathematics*, ISSN: 2227-7390, 9 (12), 1-40, 2021, inozemstvo
- Lopac, N.; Jurdana, I.; Lerga, J.; Wakabayashi, N., *Particle-Swarm-Optimization-Enhanced Radial-Basis-Function-Kernel-Based Adaptive Filtering Applied to Maritime Data*, *Journal of marine science and engineering*, ISSN: 2077-1312, 9 (4), 1-35, 2021, inozemstvo
- Lerga, J.; Saulig, N.; Stanković, Lj.; Seršić, D., *Rule-Based EEG Classifier Utilizing Local Entropy of Time-Frequency Distributions*, *Mathematics*, ISSN: 2227-7390, 9 (4), 1-27, 2021, inozemstvo
- Stanković, Lj.; Brajović, M.; Stanković, I.; Lerga, J.; Daković, M., *RANSAC-Based Signal Denoising Using Compressive Sensing, Circuits, systems, and signal processing*, ISSN: 0278-081X 40, 3907-3928, 2021, inozemstvo
- Lopac, N.; Lerga, J.; Cuoco, E., *Gravitational-Wave Burst Signals Denoising Based on the Adaptive Modification of the Intersection of Confidence Intervals Rule*, *Sensors*, ISSN: 1424-8220, 20 (23), 1-28, 2020, inozemstvo
- Arbula, D.; Ljubić, S., *Indoor Localization Based on Infrared Angle of Arrival Sensor Network Sensors*, ISSN: 1424-8220, 20 (21), 1-32, 2020, inozemstvo
- Salkanović, A.; Stojković, M.; Ljubić, S., *The Effect of Dwell Time on Swipe-based Pie-Menu Navigation Efficiency*, *International Journal of Online and Biomedical Engineering (iJOE)*, eISSN: 2626-8493, 16 (15), 4-22, 2020, inozemstvo
- Ljubić, S.; Hrzić, F.; Salkanović, A.; Štajduhar, I., *Augmenting Around-Device Interaction by Geomagnetic Field Built-in Sensor Utilization*, *Sensors*, ISSN: 1424-8220, 21 (9), 1-24, 2021, inozemstvo
- Sušanj, D.; Pinčić, D.; Lenac, K., *Effective Area Coverage of 2D and 3D Environments With Directional and Isotropic Sensors*, *IEEE Access*, ISSN: 2169-3536, 8, 185595-185608, 2020, inozemstvo
- Nikolić, F.; Štajduhar, I.; Čanadija, M., *Castling Microstructure Inspection Using Computer Vision: Dendrite Spacing in Aluminum Alloys*, *Metals*, EISSN: 2075-4701, 11 (5), 756, 1-13, 2021, inozemstvo
- Hrzić, F.; Tschauner, S.; Sorantin, E.; Štajduhar, I., *XAOM: A method for automatic alignment and orientation of radiographs for computer-aided medical diagnosis*, *Computers in Biology and Medicine*, ISSN: 0010-4825, 132, 104300, 1-12, 2021, inozemstvo
- Hrzić, F.; Žužić, I.; Tschauner, S.; Štajduhar, I., *Cast Suppression in Radiographs by Generative Adversarial Networks*, *Journal of the American Medical Informatics Association*, proofing, 2021, inozemstvo

- Sorantin, E.; Grasser, M. G.; Hemmelmayr, A.; Tschauner, S.; Hrzić, F.; Weiss, V.; Lacekova, J.; Holzinger, A., *The Augmented Radiologist: Artificial Intelligence in the Practice of Radiology Padiatric Radiology, proofing*, 2021, inozemstvo
- Špoljar, D.; Jukić, O.; Sikirica, N.; Lenac, K.; Filjar, R., *Modelling GPS Positioning Performance in Northwest Passage during Extreme Space Weather Conditions*, *TransNav*, 2083-6473, 2083-6481, 15, 165-169, 2021, inozemstvo
- Lenac, K.; Cuzzocrea, A.; Mumolo, E., *A Novel Genetic Scan-Matching-Based Registration Algorithm for Supporting Moving Objects Tracking Effectively and Efficiently*, *IEEE Access*, 2169-3536, 9, 91741-91753, 2021, inozemstvo
- Lenac, K.; Filjar, R., *Recurrence plot analysis of GPS ionospheric delay time series in extreme ionospheric conditions*, *Computers & geosciences*, 0098-3004, 147, 2021, inozemstvo

### POZVANA PREDAVANJA | INVITED LECTURES

- Jonatan Lerga, *Labor Market Trends Leading to Establishing the Center for AI and Cybersecurity in Rijeka, Exploring Digital Legal Landscapes*, 2020, Rijeka, Hrvatska
- Jonatan Lerga, *Time-Frequency Signal Analysis with Matlab*, Faculty of Informatics, Department of Programming Languages and Compilers, Eötvös Loránd University, 2020, Budimpešta, Mađarska
- Ivan Štajduhar, *The reach and limitations of machine intelligence*, ICAIH 2020 The 3rd International Conference on AI Humanities, 2020, Seul, Južna Koreja
- Ivan Štajduhar, *BirdbrAln Genius – the Reach and limitations of Machine Intelligence*, COVID – 19 MESSAGES III / STEM for human species survival, 2020, Rijeka, Hrvatska
- Goran Mauša, *Artificial Intelligence Based Design of Short Peptides*, Data Science Croatia 2021 2021, Zagreb, Hrvatska
- Goran Mauša, *Application of soft computing in peptide design*, COVID-19 Messages III: Stem for Human Species Survival, 2020, Rijeka, Hrvatska
- Kristijan Lenac, *Blockchain solutions for postpandemic society*, COVID – 19 MESSAGES III / STEM for human species survival, 2020, Rijeka, Hrvatska
- Kristijan Lenac, *Primjene blockchain tehnologije*, IAESTE – Mjesec Edukacije Studenata, 2021, Rijeka, Hrvatska

### MEĐUNARODNI KONGRESI | INTERNATIONAL CONGRESSES

- Selimović, D.; Prpić Oršić, J.; Lerga, J., *Improved Resolution of Time-Frequency Distributions in Decision Support Systems for Green and Safe Ship Routing*, The 14th Baška GNSS Conference: Technologies, Techniques and Applications Across PNT and The 1st Workshop on Smart Blue and Green Maritime Technologies, 15-15, 2021, Baška, Hrvatska
- Njirjak, M.; Otović, E.; Jozinović, D.; Lerga, J.; Mauša, G.; Michelini, A.; Štajduhar, I., *Machine Learning Classification of Cohen's Class Time-Frequency Representations of Non-Stationary Signals: Effects on Earthquake Detection*, EGU General Assembly 2021, 2021, Beč, Austrija
- Otović, E.; Njirjak, M.; Jozinović, D.; Mauša, G.; Michelini, A.; Štajduhar, I., *Intra-domain and cross-domain transfer learning for time series* EGU General Assembly 2021, 2021, Beč, Austrija
- Salkanović, A.; Ljubić, S., *Touchless Interaction on Mobile Devices Using Embedded Ambient Light Sensor*, Proceedings of the 9th International Conference on Distributed, Ambient and Pervasive Interactions (DAPI 2021), held as part of the 23rd HCI International Conference (HCII 2021), ISBN: 978-3-030-77014-3, 153-163, 2021, "Washington DC, USA"



- Skoki, A.; Lerga, J.; Štajduhar, I., *ML-Based Approach for NFL Defensive Pass Interference Prediction Using GPS Tracking Data* Hrvatska udruga za informacijsku, komunikacijsku i elektroničku tehnologiju - MIPRO, 2021, Rijeka, Hrvatska
- Manojlović, T.; Milanić, M.; Štajduhar, I., *Deep embedded clustering algorithm for clustering PACS repositories*, 2021 IEEE 34th International Symposium on Computer- Based Medical Systems (CBMS), ISBN: 978-1-6654-3107-1, 401-406, 2021, Aveiro, Portugal
- Štajduhar, I.; Manojlović, T.; Hrzić, F.; Napravnik, M.; Glavaš, G.; Milanić, M.; Tschauer, S.; Mamula Saračević, M.; Miletić, D., *Analysing large repositories of medical images*, Lecture Notes in Bioinformatics (LNBI) - International Conference on Bioengineering, Biomedical Signal and Image Processing BIOMESIP 2021, 2021, Granada, Španjolska
- Dumencić, S.; Tschauer, S.; Hrzić, F.; Štajduhar, I., *Automatic extraction of multiple-study X-ray images*, Proceedings of the 2021 International Conference on INnovations in Intelligent Systems and Applications (INISTA), 2021, Istanbul, Turska
- Otović, E.; Njirjak, M.; Žužić, I.; Kalafatović, D.; Mauša, G., *Genetic Algorithm Parametrization for Informed Exploration of Short Peptides Chemical Space* Proceeding of International Conference on Software, Telecommunications and Computer Networks (SoftCOM 2020) ISBN:978-1-7281-7538-6, 1 - 3, 2020, Split, Hrvatska
- Joler, M., *Challenges Toward Design and Fabrication of Smart(er) Clothing* The Fourth International Conference on Industrial Informatics - Computing Technology, Intelligent Technology, Industrial Information Integration, 2020, Shantou, China
- Jukić, O.; Iliev, Teodor B.; Sikirica, N.; Lenac, K.; Špoljar, D.; Filjar, R., *A method for GNSS positioning performance assessment for location-based services*, Proc of 28th Telecommunications Forum TELFOR 2020 / Paunović, Đorđe (ur.), 2020, Belgrade, Serbia

- University of Montenegro, Podgorica, Crna Gora, Montenegro
- Eötvös Loránd University, Faculty of Informatics, Budapest, Mađarska, Hungary
- J. Selye University, Faculty of Economics, Komarno, Slovačka, Slovakia
- Brno University of Technology, Brno, Češka Republika, Czech Republic
- Shantou University, Shantou, Kina, China
- Faculty of Computer and Information Science, University of Ljubljana, Slovenija, Slovenia
- Faculty Of Mechanical Engineering, University of Ljubljana, Slovenija, Slovenia



## MEĐUNARODNA SURADNJA | INTERNATIONAL COLLABORATIONS

- University of Trieste, Italija, Italy
- AIBS Lab S.r.l., Italija, Italy
- Faculty of Mathematics and Physics, University of Ljubljana, Slovenija, Slovenia
- University of Mannheim, Njemačka, Germany
- Medical University of Graz, Austrija, Austria
- Faculty of electrical engineering, computing and informatics, University of Maribor, Slovenija, Slovenia
- Institute for research in biomedicine, Barcelona, Španjolska, Spain
- Nova School of Science and Technology, Lisboa, Portugal
- Informatics Engineering Department, University of Coimbra, Portugal
- Department of mathematics and informatics, Faculty of Sciences, University of Novi Sad, Srbija, Serbia
- University of Maribor, Faculty of Electrical Engineering and Computer Science, Maribor, Slovenija, Slovenia
- University of Szeged, Institute of Informatics, Szeged, Mađarska, Hungary
- Johannes Kepler University Linz, Institute of Signal Processing, Linz, Austrija, Austria



**5.<sup>10</sup>**

**ZAVOD ZA TEHNIČKU MEHANIKU**  
DEPARTMENT OF ENGINEERING MECHANICS





## DJELATNICI FACULTY AND STAFF

### PREDSTOJNIK ZAVODA | DEPARTMENT HEAD:



Prof. dr. sc. / Prof. D. Sc. **Goran Turkalj**

*čvrstoća konstrukcija; nelinearna analiza konstrukcija; stabilnost konstrukcija; računarska analiza konstrukcija*  
strength of materials; nonlinear structural analysis; structural stability; computational structural analysis

### REDOVITI PROFESORI U TRAJNOM ZVANJU | TENURED PROFESSORS



**Marko Čanadija**

*termomehanika; eksperimentalna mehanika; statika; metoda konačnih elemenata; nanomehanika*  
thermomechanics; experimental mechanics; statics; finite element method; nanomechanics



**Domagoj Lanc**

*čvrstoća konstrukcija; elasto-plastomehanika; stabilnost konstrukcija; kompozitne konstrukcije*  
strength of materials; elasto-plastomechanics; structural stability; composite structures



**Roberto Žigulić**

*kinematika; dinamika; dinamika strojeva i robota; mehatronika; eksperimentalna mehanika*  
kinematics; dynamics; dynamics of robots and machines; mechatronics; experimental mechanics

### REDOVITI PROFESOR | PROFESSOR



**Sanjin Braut**

*kinematika; dinamika; vibracije; eksperimentalna mehanika; trajnost strojeva i konstrukcija; dinamika rotora*  
kinematics; dynamics; vibration; experimental mechanics; durability of machines and structures; rotordynamics

### IZVANREDNI PROFESOR | ASSOCIATE PROFESSOR

**Marino Brčić**



*statika; čvrstoća konstrukcija; mehanika i elementi konstrukcija; laboratorijske vježbe; eksperimentalna ispitivanja u mehanici konstrukcija i strojeva; metoda konačnih elemenata; nanomehanika*  
statics; strength of materials; mechanics and structural elements; experimental methods in mechanics; finite element method; nanomechanics

### DOCENTI | ASSISTANT PROFESSORS

**Sanjin Krščanski**



*statika; čvrstoća konstrukcija; mehanika i elementi konstrukcija; trajnost strojeva i konstrukcija; zamor; mehanika loma*  
statics; strength of materials; mechanics and structural elements; durability of machines and structures; fatigue; fracture mechanics

**Ante Skoblar**



*kinematika; dinamika; vibracije; akustika*  
kinematics; dynamics; vibration; acoustics

**Goranka Štimac Rončević**



*kinematika; dinamika; regulacija; aktivni magnetski ležajevi*  
kinematics; dynamics; control; active magnetic bearings

### ASISTENTI | ASSISTANTS

**Damjan Banić**



*čvrstoća konstrukcija; stabilnost konstrukcija; kompozitne konstrukcije; laboratorijske vježbe*  
strength of materials; structural stability; composite structures; laboratory exercises

**Valentina Košmerl**



*umjetna inteligencija; strojno učenje; metoda konačnih elemenata; nanomehanika; statika*  
artificial intelligence; machine learning; finite element method; nanomechanics; statics

**Sandra Kvaternik Simonetti**



*čvrstoća konstrukcija; stabilnost konstrukcija; kompozitne konstrukcije; laboratorijske vježbe*  
strength of materials; structural stability; composite structures; laboratory exercises



## NASTAVA I ZNANOST

### EDUCATION AND SCIENCE

Courses are running in the field of applied mechanics and includes analytical, computational and experimental mechanics. According to the content of consideration, here belong: statics, strength of materials, structural stability, structural mechanics, optimization of structures, finite element analysis, thin-walled structures, computational analysis of structures, composite structures, experimental testing of structures and machines, thermomechanics, contact mechanics, kinematics, dynamics, vibrations, vibroacoustics, dynamic system control, durability of machines and structures; mechatronics, etc.



**Daniel Morožin**

*kinematika; dinamika; vibracije*  
*kinematics; dynamics; vibration*



**Martin Zlatić**

*umjetna inteligencija; strojno učenje; metoda konačnih elemenata; termomehanika; statika; čvrstoća konstrukcija; laboratorijske vježbe*  
*artificial intelligence; machine learning; finite element method; thermomechanics; statics; strength of materials; laboratory exercises*

#### STRUČNI SURADNIK | ASSOCIATE



**Domagoj Vrtovšnik**

*rad na projektu; eksperimentalna ispitivanja*  
*work on the project; experimental research*

Nastava se izvodi iz područja primijenjene mehanike što uključuje analitičku, računalnu i eksperimentalnu mehaniku. Prema sadržaju razmatranja ovdje spadaju: statika, čvrstoća konstrukcija, stabilnost konstrukcija, mehanika konstrukcija, optimizacija konstrukcija, konačnoelementna analiza, tankostijene konstrukcije, računalna analiza konstrukcija, kompozitne konstrukcije, eksperimentalna ispitivanja u mehanici konstrukcija i strojeva, termomehanika, kontaktna mehanika, kinematika, dinamika, vibracije; akustika, regulacija i upravljanje dinamičkim sustavima; trajnost strojeva i konstrukcija; mehatronika, i.t.d.

#### KOLEGIJI NA PREDDIPLOMSKIM SVEUČILIŠNIM STUDIJIMA

| UNDERGRADUATE UNIVERSITY COURSES

- Statika
- Čvrstoća konstrukcija I
- Osnove primjene metode konačnih elemenata
- Čvrstoća konstrukcija
- Računarska analiza konstrukcija
- Mehanika i elementi konstrukcija
- Kinematika
- Dinamika

- Statics
- Strength of Materials I
- Introduction to Finite Element Method (FEM)
- Strength of Materials
- Computational Structural Analysis
- Mechanics and Structural Elements
- Kinematics
- Dynamics

#### KOLEGIJI NA DIPLOMSKIM SVEUČILIŠNIM STUDIJIMA

| GRADUATE UNIVERSITY COURSES

- Čvrstoća konstrukcija I
- Metoda konačnih elemenata čvrstih tijela
- Optimalni dizajn konstrukcija
- Eksperimentalna ispitivanja u mehanici konstrukcija i strojeva
- Termomehanika
- Stabilnost konstrukcija
- Teorija strojeva i mehanizama
- Eksperimentalna ispitivanja u mehanici konstrukcija i strojeva
- Regulacija i upravljanje dinamičkim sustavima
- Trajnost strojeva i konstrukcija
- Vibracije

- Strength of Materials II
- Finite Element Method of Solids
- Optimization of Structures
- Experimental Testing in Mechanics of Structures and Machines
- Thermomechanics
- Stability of Structures
- Theory of machines and mechanisms
- Experimental Testing in Mechanics of Structures and Machines
- Dynamic Systems Control
- Durability of Machines and Structures
- Vibration

#### KOLEGIJI NA PREDDIPLOMSKIM STRUČNIM STUDIJIMA

| UNDERGRADUATE VOCATIONAL COURSES

- Mehanika I
- Mehanika i elementni konstrukcija ST
- Čvrstoća
- Mehanika II

- Mechanics I
- Mechanics and Structural Elements ST
- Strength of Materials
- Mechanics II



#### PROFESOR EMERITUS | PROFESSOR EMERITUS



**Josip Brnić**

*teorija elastičnosti i plastičnosti; metoda konačnih elemenata; eksperimentalna mehanika; optimizacija konstrukcija; mehanika grešaka i loma*  
*theory of elasticity and plasticity; finite element analysis; experimental mechanics; optimization of structure; fracture mechanics*

#### VANJSKI SURADNICI | ASSOCIATES

##### Igor Pešić

Sveučilište u Rijeci, Odsjek za politehniku  
| University of Rijeka, Department of Polytechnics

*statika; čvrstoća konstrukcija*  
*statics; strength of materials*

##### Nicholas Fantuzzi

Alma Mater Studiorum Universita di Bologna, Bologna, Italija  
| Alma Mater Studiorum University of Bologna, Bologna, Italija

*tehnička mehanika; kompozitne konstrukcije*  
*engineering mechanics; composite structures*

##### Franc Kosel

Fakulteta za Strojništvo, Univerza v Ljubljani, Ljubljana, Slovenija  
| Faculty of Mechanical Engineering, University of Ljubljana, Ljubljana, Slovenia

*tehnička mehanika; čvrstoća;*  
*elastoplastomehanika*

*engineering mechanics; strength of materials;*  
*elasto-plastomechanics*

##### Neven Munjas

Istarsko veleučilište  
| Istrian University

*statika; čvrstoća konstrukcija; mehanika i elementi konstrukcija*

*statics; strength of materials; mechanics and structural elements*

##### Stojan Kravanja

Fakulteta za gradbeništvo, Univerza v Mariboru, Maribor, Slovenija  
| Faculty of Civil Engineering, University of Maribor, Maribor, Slovenia

*tehnička mehanika; optimizacija konstrukcija*  
*engineering mechanics; structural optimization*



## KOLEGIJI NA POSLIJEDIPLOMSKIM SVEUČILIŠNIM (DOKTORSKIM) STUDIJIMA

## | POSTGRADUATE UNIVERSITY (DOCTORAL) COURSES

- |  |  |
|--|--|
| • Elastomehanika i plastomehanika              | • Elastomechanics and Plastomechanics                  |
| • MKE i optimizacija konstrukcija              | • FEM and Optimization of Structures                   |
| • IP iz termomehanike                          | • Advanced Thermomechanics                             |
| • Nanomehanika                                 | • Nanomechanics  |
| • Nelinearna analiza konstrukcija              | • Nonlinear Structural Analysis                        |
| • Računarska analiza stabilnost konstrukcija   | • Computational Structural Stability Analysis          |
| • Vibracije i trajnost strojeva i konstrukcija | • Vibrations and Durability of Machines and Structures |
| • Dinamika nelinearnih mehaničkih sustava      | • Dynamics of nonlinear mechanical systems             |
| • Zaštita od buke i vibracija                  | • Protection against Noise and Vibration               |
| • Viskoelastičnost i viskoplastičnost          | • Viscoelasticity and Viscoplasticity                  |
| • Mehanika kompozita                           | • Mechanics of Composites                              |
| • Cjelovitost konstrukcija                     | • Structural integrity                                 |

## ZNASTVENOISTRAŽIVAČKI RAD | SCIENTIFIC RESEARCH

- *Primijenjena mehanika: računalna mehanika, eksperimentalna mehanika, mehanika grešaka i loma konstrukcija, optimalni dizajn konstrukcija, stabilnost konstrukcija, vibracije, vibroakustika, dinamika strojeva i konstrukcija, dinamika rotora, mehatronika, termomehanika, nanomehanika, integritet konstrukcija*  
Applied mechanics: computational mechanics, experimental mechanics, failure and fracture mechanics of structures, optimal structural design, structural stability, vibrations, vibroacoustics, dynamics of structures and machines, rotor dynamics, mechatronics, thermomechanics, nanomechanics, structural integrity.

## PROJEKTI | PROJECTS

- *Istraživanje, analiza i modeliranje ponašanja konstrukcijskih elemenata opterećenih pri sobnoj i povišenim temperaturama, Sveučilište u Rijeci, uniri-technic-18-42, Josip Brnić.*  
Investigation, analysis and modeling the behavior of structural elements stressed at room temperature and high temperatures, University of Rijeka, uniri-technic-18-42, Josip Brnić.
- *Numeričko modeliranje FG kompozitnih konstrukcija grednog tipa, Sveučilište u Rijeci, uniri-technic-18-139, Domagoj Lanc*  
Numerical modeling of FG composite beam-type structures, University of Rijeka, uniri-technic-18-139, Domagoj Lanc
- *Konačnoelementni modeli za analizu nelinearnog odziva tankostjenih grednih konstrukcija, Sveučilište u Rijeci, uniri-technic-18-107, Goran Turkalj.*  
Finite element models for nonlinear analysis of thin-walled beam-type structure, University of Rijeka, uniri-technic-18-107, Goran Turkalj.
- *Nelinearno dinamičko ponašanje rotacijskih strojeva, uniri-tehnic-18-225, Sveučilište u Rijeci, Sanjin Braut, od 2019.*  
Nonlinear dynamic behavior of rotating machines, uniri-tehnic-18-225, University of Rijeka, Sanjin Braut, since 2019.
- *Procjena granične nosivosti inženjerskih konstrukcija, LOCAPES, IP-2019-04-8615, HRZZ, Domagoj Lanc.*  
Estimation of limit load capacity of engineering structures, LOCAPES, IP-2019-04-8615, HRZZ, Domagoj Lanc.
- *Nelokalni mehanički modeli nanogreda, IP-2019-04-4703. Hrvatska zaklada za znanost, Marko Čanađija, od 2020.*  
Nonlocal mechanical models of nanobeams, IP-2019-04-4703, Croatian Science Foundation, Marko Čanađija, since 2020.

- *Mehaničko ponašanje nanostruktura, uniri-tehnic-18-37 Sveučilište u Rijeci, Marko Čanađija, od 2019.*  
Mechanical behaviour of nanostructures, uniri-tehnic-18-37, University of Rijeka, Marko Čanađija, since 2019.

## PUBLIKACIJE | PUBLICATIONS

## KNJIGE | BOOKS

- *Kršćanski, S.; Brnić, J., Design and Applications III: Virtual Crack Closure as a Method for Calculating Stress Intensity Factor of Cracks in Metallic Specimens Springer, 978-3-030-68276-7 / 1869-8433, 2021, Cham, Switzerland, poglavlje u knjizi*

## RADOVI U ČASOPISIMA | JOURNAL PAPERS

- *Barretta, R.; Čanađija, M.; Marotti de Sciarra, F.o; Skoblar, A.; Žigulić, R., Dynamic behaviour of nano-beams under axial loads: integral elasticity modelling and size-dependent eigenfrequencies assessment, Mathematical Methods in the Applied Sciences, 1099-1476 44, special issue, 1-18, 2021*
- *Braut, S.; Sikanen, E.; Nerg, J.; Sopanen, J.; Božić, Ž., Fatigue life prediction of Electric RaceAbout (ERA) traction motor rotor, Procedia structural integrity, 2452-3216, 31, 45-50, 2021*
- *Braut, S.; Tevčić, M.; Butković, M.; Božić, Ž.; Žigulić, R., Application of modified Locati method in fatigue strength testing of a turbo compressor blade, Procedia structural integrity, 2452-3216 31, 33-37, 2021*
- *Brčić, M.; Krščanski, S.; Brnić, J., Rotating Bending Fatigue Analysis of Printed Specimens from Assorted Polymer Materials, Polymers, 2073 - 4360, 13 (7), 1210; 11, 2021*
- *Brnić, J.; Brčić, M.; Baloš, S.; Vukelić, G.; Krščanski, S.; Milutinović, M.; Dramićanin, M., S235JRC+C Steel Response Analysis Subjected to Uniaxial Stress Tests in the Area of High Temperatures and Material Fatigue, Sustainability, 2071 - 1050, 13 (10), 5675; 16, 2021*
- *Brnić, J.; Brčić, M.; Krščanski, S.; Niu, J.; Chen, S.; Gao, Z., Deformation Behavior of C15E+C Steel under Different Uniaxial Stress Tests, Metals, 2075 - 4701, 10 (11), 1445; 19, 2020*
- *Brnić, J.; Krščanski, S.; Brčić, M., Comparison of responses of different types of steel alloys under the same loading and environmental conditions, Proceedings of the Institution of Mechanical Engineers, Part L: Journal of Materials: Design and Applications 1464 - 4207, 235 (6), 1194 - 1202, 2021*
- *Ding, B.; Ren, W.; Zhong, Y.; Yuan, X.; Peng, J.; Zheng, T.; Shen, Z.; Guo, Y.; Xuan, W.; Yu, J.; Brnić, J.; Liaw, P. K., Accuracy of the predicting for creep-fatigue cyclic life based on parameters in a characteristic cycle, Engineering fracture mechanics, 0013 - 7944, 255, 107955; 18, 2021*
- *Ding, B.; Ren, W.; Zhong, Y.; Yuan, X.; Peng, Y.; Zheng, T.; Shen, Z.; Guo, Y.; Xuan, W.; Yu, Y.; Brnić, J.; Liaw, P. K., Analysis of the fully-reversed creep-fatigue behavior with tensile-dwell periods of superalloy DZ445 at 900 °C, Engineering fracture mechanics, 0013 - 7944, 250, 107781; 18, 2021*
- *Gao, Z.; Ji, F.; Cheng, D.; Yin, C.; Niu, J.; Brnić, J., Hydrolysis-Based Hydrogen Generation Investigation of Aluminum System Adding Low-Melting Metals, Energies, 1996 - 1073, 14 (5) 1433; 12, 2021*
- *Gao, Z.; Yin, C.; Cheng, D.; Feng, J.; He, P.; Niu, J.; Brnić, J., Sintering Bonding of SiC Particulate Reinforced Aluminum Metal Matrix Composites by Using Cu Nanoparticles and Liquid Ga in Air Nanomaterials, 2079 - 4991, 11 (7), 1800; 14, 2021*
- *Lanc, D.; Ivančić, I.; Katalenić, M., Buckling analysis of columns made of functionally graded materials via Rayleigh-Ritz method, Mathematical modeling, 2535-0986, 1, 18-21, 2020*





- Nikolić, .; Štajduhar, I., Čanađija, M., *Casting Microstructure Inspection Using Computer Vision: Dendrite Spacing in Aluminum Alloys*, *Metals*, 2075-47015, 756, 2021
- Vukelić, G.; Vizontin, G.; Brnić, J.; Brčić, M.; Sedmak, F. *Long-Term Marine Environment Exposure Effect on Butt-Welded Shipbuilding Steel*, *Journal of marine science and engineering* 2077 - 1312, 9 (5), 491; 12, 2021

#### MEDUNARODNI KONGRESI | INTERNATIONAL CONGRESSES

- Braut, S.; Skoblar, A.; Štimac Rončević, G.a; Žigulić, R., *Effect of L/D ratio and clearance of 3-lobe taper land bearing on stability of flexible rotor system*, *Vibrations in Rotating Machinery - VIRM 12*, 978-0-367-67742-8, 377-387, 2020, London, UK
- Brnić, J.; Krščanski, S.; Brčić, M., "Comparison of responses of different types of steel alloys under the same loading and environmental conditions, MDA 2020, 3rd International Conference on Materials Design and Applications, 34, 2020, Porto, Portugal
- Brčić, M.; Krščanski, S.; Brnić, J., *Rotating fatigue analysis of 3D printed specimens from assorted materials*, MDA 2020, 3rd International Conference on Materials Design and Applications, 112, 2020, Porto, Portugal
- Krščanski, S.; Brnić, J., *Virtual crack closure as a method for calculating stress intensity factor of cracks in metallic specimens*, MDA 2020, 3rd International Conference on Materials Design and Applications, 64, 2020, Porto, Portugal
- Lanc, D.; Turkalj, G.; Kvaternik Simonetti, S., *FG beam thermal buckling analysis* MECHCOMP7, 7th International Conference on Mechanics of Composites, 2038, 2021, Porto, Portugal
- Turkalj, .; Banić, D.; Lanc, D., *A locking-free shear deformable beam model for stability analysis of beam-type structures with composite thin-walled cross-sections* MECHCOMP7, 7th International Conference on Mechanics of Composites, 2041, 2021, Porto, Portugal
- Čanađija, M., *Mechanical Properties of Carbon Nanotubes - Deep Learning Approach*, NT21: International Conference on the Science and Application of Nanotubes and Low-Dimensional Materials, 2021, Rice University, Houston, USA
- Zlatić, M.; Čanađija, M., *Reducing computational time for FEM post- processing through the use of feedforward neural networks*, VI ECCOMAS Young Investigators Conference, 2021, Valencia, Spain
- Skoblar, A.; Barretta, R.; Čanađija, M.; Marotti de Sciarra, F.; Žigulić, R., *Free Vibration of Bernoulli-Euler Nano-Beam Under Axial Load Using Nonlocal Strain-driven And Stress-driven Model*, 14th World Congress in Computational Mechanics (WCCM) ECCOMAS Congress 2020, 2021, online, 11 – 15 January 2021, Paris, France
- Muminović, J, Adis; Braut, S.; Božić, Ž.; Pervan, N.; Skoblar, A., *Failure Analysis of Gears Manufactured Using Additive Manufacturing*, 5th International Conference on Structural Integrity and Durability , 1, 2021, Zagreb, Hrvatska

#### MEDUNARODNA SURADNJA | INTERNATIONAL COLLABORATIONS

- La Trobe University, Department of Civil Engineering and Physical Sciences, Melbourne, Australija, Australia
- Civil Engineering Faculty, University of Maribor, Slovenija, Slovenia
- Institute of Mechanics Department of Mechanical Engineering TU Dortmund, Njemačka, Germany

- School of Materials Science and Engineering, Henan Polytechnic University, Kina, China
- Harbin Institute of Technology, School of Materials Science and Engineering, Kina, China
- University of Bologna, Italija, Italia
- Faculty of Engineering - University of Kragujevac, Srbija, Serbia
- Faculty of Mechanical Engineering - University of Montenegro, Crna Gora, Montenegro
- Faculty of Mechanical Engineering, University of Ljubljana, Slovenija, Slovenia
- Institute of Materials and Welding, Graz University of Technology, Austrija, Austria
- L'Università degli Studi di Napoli Federico II, Naples, Italija, Italy
- Lappeenranta University of Technology, Finska, Finland
- Dipartimento di Ingegneria Meccanica e Aerospaziale, Politecnico di Torino, Italija, Italy
- Faculty of Mechanical Engineering, University of Sarajevo, BiH, Bosna and Herzegovina
- Dipartimento di Meccanica, Politecnico di Milano, Italija, Italy



**5<sup>11</sup>**

**ZAVOD ZA TERMODINAMIKU  
I ENERGETIKU**

DEPARTMENT OF THERMODYNAMICS AND  
ENERGY ENGINEERING





## DJELATNICI FACULTY AND STAFF

### PREDSTOJNIK ZAVODA | DEPARTMENT HEAD:



Prof. dr. sc. / Prof. D. Sc. **Branimir Pavković**

*tehnika hlađenja; kompresori; procesna oprema; dizalice topline; energetska učinkovitost; obnovljivi izvori energije*  
refrigeration; compressors; process equipment; heat pumps; energy efficiency; renewable energy sources

### REDOVITI PROFESORI U TRAJNOM ZVANJU | TENURED PROFESSORS

#### Kristian Lenić



*termodinamika; izmjenjivači topline; numeričko modeliranje prijenosa topline i tvari; obnovljivi izvori energije*  
thermodynamics; heat exchangers; numerical modeling of heat and mass transfer; renewable energy sources

#### Tomislav Mrakovčić



*brodski energetska sustavi; brodski pogonski sustavi; brodski pomoćni strojevi; numeričko modeliranje prijenosa topline i tvari*  
marine energy systems; marine propulsion systems; marine auxiliary machinery; numerical modeling of heat and mass transfer

#### Anica Trp



*termodinamika; izmjenjivači topline; numeričko modeliranje prijenosa topline i tvari; obnovljivi izvori energije*  
thermodynamics; heat exchangers; numerical modeling of heat and mass transfer; renewable energy sources

### IZVANREDNI PROFESORI | ASSOCIATE PROFESSORS

#### Tomislav Senčić



*toplinski strojevi i uređaji; goriva, maziva i voda*  
thermal machines; fuels, lubricants and water

#### Igor Wolf



*tehnika grijanja; sustavi ventilacije i klimatizacije; obnovljivi izvori energije; središnji nadzorni i upravljački sustavi; energetska učinkovitost; mjerenja u termotehnici*  
hvac systems; renewable energy sources; central management and control systems; energy efficiency; thermal measurements

### DOCENTI | ASSISTANT PROFESSORS

#### Paolo Blecich



*termodinamika; numeričko modeliranje prijelaza topline i izmjene tvari; obnovljivi izvori energije*  
thermodynamics; numerical modelling of heat and mass transfer; renewable energy sources

#### Igor Bonefačić



*termodinamika; numeričko modeliranje procesa izgaranja, prijenosa topline i tvari; obnovljivi izvori energije*  
thermodynamics; numerical modelling of combustion, heat and mass transfer; renewable energy sources

#### Ozren Bukovac



*motori s unutrašnjim izgaranjem; termodinamika; toplinski strojevi; numeričko modeliranje; neuronske mreže*  
internal combustion engines; thermodynamics; heat engines; numerical modeling; neural networks

#### Boris Delač



*tehnika hlađenja; mjerenja u termotehnici; kompresori; procesna oprema; dizalice topline*  
refrigeration; thermal measurements; compressors; process equipment; heat pumps

#### Viktor Dragičević



*energetski sustavi; energetska i procesna uređaji; inženjerstvo zaštite okoliša*  
energy systems; energy and process facilities; environmental engineering

#### Vladimir Glažar



*termodinamika; izmjenjivači topline; numeričko modeliranje prijenosa topline i tvari; energetska postrojenja; inženjerska vizualizacija*  
thermodynamics; heat exchangers; numerical modeling of heat and mass transfer; energy plants; engineering visualization

**Vedran Mrzljak**

*motori s unutarnjim izgaranjem; termodinamika; toplinski strojevi; toplinske turbine; energetska postrojenja; numeričko modeliranje*  
*internal combustion engines; thermodynamics; heat engines; heat turbines; energy plants; numerical modeling*

**ASISTENTI | ASSISTANTS****Josip Batista**

*termodinamika; izmjenjivači topline; numeričko modeliranje prijenosa topline i tvari; obnovljivi izvori energije*  
*thermodynamics; heat exchangers; numerical modeling of heat and mass transfer; renewable energy sources*

**Mateo Kirinčić**

*termodinamika; izmjenjivači topline; numeričko modeliranje prijenosa topline i tvari; obnovljivi izvori energije*  
*thermodynamics; heat exchangers; numerical modeling of heat and mass transfer; renewable energy sources*

**Vedran Medica - Viola**

*numeričko modeliranje i simulacije toplinskih sustava; brodski sustavi; motor s unutarnjim izgaranjem; toplinske turbine; tehnika hlađenja*  
*numerical modelling and simulation of thermal systems; marine systems; internal combustion engines; heat turbines; refrigeration*

**Fran Torbarina**

*termodinamika; izmjenjivači topline; numeričko modeliranje prijenosa topline i tvari; obnovljivi izvori energije*  
*thermodynamics; heat exchangers; numerical modeling of heat and mass transfer; renewable energy sources*

**PROFESOR EMERITUS | PROFESSOR EMERITUS****Špiro Milošević**

## NASTAVA I ZNANOST

### EDUCATION AND SCIENCE

*Lectures in the field of scientific fields of Mechanical Engineering, Fundamental and Interdisciplinary Engineering Sciences, the scientific branches of Process Energy Engineering, Marine Engineering, Thermodynamics, Energy Engineering and Environmental Engineering, Energy systems; Power plants; Energy equipment, facilities and engines; Environmental protection, Process engineering.*

*LLL: 1. Education of persons who are to perform energy audits and/or energy certification of buildings with a simple technical system (Module 1)*  
*2. Education of persons who are to perform energy audits and/or energy certification of buildings with a complex technical system (Module 2)*  
*3. Education program for persons who are to perform energy audits of big enterprises*

*Nastava iz područja znanstvenih polja strojarstva, temeljnih i interdisciplinarnih tehničkih znanosti, znanstvenih grana procesnog energetskeg strojarstva, brodskog strojarstva, termodinamike, energetike i inženjerstva okoliša, Energetski sistemi; Energetska postrojenja; Energetska oprema, uređaji i strojevi; Zaštita okoliša; Procesno inženjerstvo.*

*CO: 1. Program stručnog osposobljavanja osoba koje provode energetske preglede i/ili energetske certificiranje zgrada s jednostavnim tehničkim sustavom (Modul 1)*  
*2. Program stručnog osposobljavanja osoba koje provode energetske preglede i/ili energetske certificiranje zgrada sa složenim tehničkim sustavom (Modul 2)*  
*3. Program izobrazbe osoba koje provode energetske preglede za velika poduzeća*

**KOLEGIJI NA PREDDIPLOMSKIM SVEUČILIŠNIM STUDIJIMA**

| UNDERGRADUATE UNIVERSITY COURSES

- *Toplinski strojevi i uređaji*
- *Izvori energije*
- *Termodinamika I*
- *Termodinamika BG*
- *Termodinamika i energetika*
- *Energetski sustavi*
- *Tehnika grijanja*
- *Brodski pomoćni strojevi*
- *Thermal machine and devices*
- *Energy Sources*
- *Thermodynamics I*
- *Thermodynamics NA*
- *Thermodynamics and Energy Engineering*
- *Energy systems*
- *Heating Systems*
- *Marine Auxiliary Machinery*

**KOLEGIJI NA DIPLOMSKIM SVEUČILIŠNIM STUDIJIMA**

| GRADUATE UNIVERSITY COURSES

- *Goriva, maziva i voda*
- *Termodinamika II*
- *Numeričko modeliranje u termodinamici*
- *Plinska tehnika*
- *Tehnički izmjenjivači topline*
- *Termodinamika smjesa*
- *Energetski i procesni uređaji*
- *Termoenergetska postrojenja*
- *Energetska postrojenja*
- *Inženjerstvo zaštite okoliša*
- *Procesno inženjerstvo*
- *Tehnika klimatizacije i automatska regulacija*
- *Brodski termotehnički sustavi*
- *Obnovljivi izvori energije*
- *Toplinska mjerenja*
- *Fuels, lubricants and water*
- *Thermodynamics II*
- *Numerical Modelling in Thermodynamics*
- *Gas Engineering*
- *Heat Exchangers*
- *Thermodynamics of Mixtures*
- *Energy and process devices*
- *Thermal power plants*
- *Power plants*
- *Environmental engineering*
- *Process engineering*
- *Air Conditioning and Automation Systems*
- *Marine HVAC&R Systems*
- *Renewable Energy Sources*
- *Thermal Measurements*

- |  |  |  |  |  |
|--|--|--|--|--|
| • Brodski energetski uređaji                                     | • Ship Energy Facilities                             |  |  |  |
| • Brodski sustavi  | • Ship Systems                                       |  |  |  |
| • Motori   | • Internal combustion Engines                        |  |  |  |
| • Toplinske turbine  | • Heat turbines                                      |  |  |  |
| • Kompresori   | • Compressors  |  |  |  |
| • Tehnika hlađenja   | • Refrigeration                                      |  |  |  |
| • Laboratorijske vježbe u termotehnici                           | • Laboratory Practice in Thermal Engineering         |  |  |  |
| • Oprema procesnih postrojenja                                   | • Process Plants Equipment                           |  |  |  |
| • Računalno modeliranje sustava u termotehnici i termoenergetici | • Numerical Modeling of HVAC & Thermal Power Systems |  |  |  |

**KOLEGIJI NA PREDDIPLOMSKIM STRUČNIM STUDIJIMA**

| UNDERGRADUATE VOCATIONAL COURSES

- |   |   |  |  |  |
|---|---|--|--|--|
| • Toplinski strojevi i uređaji 2              | • Thermal machines and devices 2              |  |  |  |
| • Toplina                                     | • Thermodynamics                              |  |  |  |
| • Energetika u procesnoj industriji           | • Energetics in process industry              |  |  |  |
| • Zaštita okoliša i radne sredine             | • Environmental and working space protection  |  |  |  |
| • Tehnološki procesi u procesnoj industriji   | • Technological processes in process industry |  |  |  |
| • Grijanje i klimatizacija                    | • Heating and Air-Conditioning Systems        |  |  |  |
| • Brodski sustavi, pomoćni strojevi i uređaji | • Ship Systems and Auxiliaries                |  |  |  |
| • Toplinski strojevi i uređaji 1              | • Thermal machines and devices 1              |  |  |  |

**KOLEGIJI NA POSLIJEDIPLOMSKIM SVEUČILIŠNIM (DOKTORSKIM) STUDIJIMA**

| POSTGRADUATE UNIVERSITY (DOCTORAL) COURSES

- |   |  |  |  |  |
|---|--|--|--|--|
| • Eksperimentalne metode u toplinskoj tehnici i termoenergetici       | • Experimental Methods in Thermal and Power Engineering                |  |  |  |
| • Izabrana poglavlja iz toplinskih znanosti                           | • Selected Topics on Thermal Sciences                                  |  |  |  |
| • Izabrana poglavlja iz izmjenjivača topline                          | • Selected Topics on Heat Exchangers                                   |  |  |  |
| • Numeričko modeliranje prijelaza topline                             | • Numerical Modeling of Heat Transfer                                  |  |  |  |
| • Termodinamička analiza procesa                                      | • Thermodynamic Analysis of Processes                                  |  |  |  |
| • Termodinamika smjesa i toplinski uređaji                            | • Thermodynamics of Mixtures and Thermal Devices                       |  |  |  |
| • Izabrana poglavlja iz grijanja i klimatizacije                      | • Selected Topics on Heating and Air-Conditioning                      |  |  |  |
| • Obnovljivi izvori energije  | • Renewable Energy Sources   |  |  |  |
| • Izabrana poglavlja iz brodskih energetskih postrojenja              | • Selected Topics Marine Energy Systems                                |  |  |  |
| • Izabrana poglavlja iz brodskih strojnih kompleksa                   | • Selected Topics of Marine Machinery Systems                          |  |  |  |
| • Izabrana poglavlja iz tehnike hlađenja i tehnike niskih temperatura | • Selected Chapters on Refrigeration and Low Temperature Refrigeration |  |  |  |
| • Zaštita okoliša u tehnici hlađenja                                  | • Environmental Refrigeration  |  |  |  |
| • Primjena mjera energetske učinkovitosti                             | • Implementation of energy efficiency measures                         |  |  |  |
| • Izabrana poglavlja iz motora s unutarnjim izgaranjem                | • Selected chapters on internal combustion engines                     |  |  |  |
| • Suvremene konstrukcije motora                                       | • Modern engine design   |  |  |  |
| • Trajnost i pouzdanost termoenergetskih sustava                      | • Durability and reliability of thermal energy systems                 |  |  |  |
| • Izabrana poglavlja iz toplinskih turbostrojeva                      | • Selected chapters on thermal turbomachines                           |  |  |  |
| • Numeričko modeliranje u tehnici hlađenja                            | • Numerical modelling in refrigeration                                 |  |  |  |
| • Optimizacija energetskih sustava                                    | • Optimization of energy systems                                       |  |  |  |

**ZNANSTVENOISTRAŽIVAČKI RAD | SCIENTIFIC RESEARCH**

- Istraživanja na toplinskim aparatima i uređajima, izmjenjivačima topline i toplinskim spremnicima koja obuhvaćaju teorijska i laboratorijska istraživanja prijelaza topline, prijenosa mase te izmjene topline pri promjeni faza; istraživanja i optimizacija sustava grijanja i klimatizacije te sustava za korištenje obnovljivih izvora energije; istraživanja na području rashladne tehnike koja obuhvaćaju kompresijske i apsorpcijske rashladne uređaje i dizalice topline; istraživanja u području energetske učinkovitosti i optimizacija termotehničkih sustava grijanja, hlađenja i

*Klimatizacije; istraživanja utjecaja parametara vlažne pare na proces erozije rotorskih lopatica toplinskih turbina; istraživanja erozije korozije protočnog dijela parnih turbina; istraživanja mogućnosti smanjenja emisije štetnih tvari motora s unutarnjim izgaranjem uz zadržavanje niske specifične potrošnje goriva te s ciljem povećanja specifične snage i pouzdanosti u preuzimanju naglih opterećenja snage kod motora s prednabijanjem; istraživanja iz brodskog strojarstva s ciljem optimalnog i energetski racionalnog vođenja brodskih pogonskih sustava; istraživanja na području optimizacije energetskih sistema i zaštite okoliša u energetskim postrojenjima.*

*Research on heat devices, heat exchangers and heat storages which encompass theoretical and laboratory research of heat and mass transfer, as well as heat transfer during phase change processes; research and optimization of heating and cooling systems, as well as of renewable energy systems; research into the field of refrigeration which embraces compression and absorption cooling devices and heat pumps; research into energy efficiency and optimization of HVAC&R systems; research into influence of wet steam parameters on the erosion process of rotor turbine blades; research into erosion - corrosion in the flowing part of steam turbines; research into reducing pollution species emission of internal combustion engines while retaining low specific fuel consumption and aiming at increasing specific power and reliability by sudden overload of a super charged engine; research to field of marine engineering aiming at the optimizing ships power plant control; investigation into optimisation of energy systems and environmental protection in energy plants.*

- Članovi Zavoda uključeni su u rad istraživačkog projekta financiranog od Hrvatske zaklade za znanost pod nazivom Povećanje energetske učinkovitosti izmjenjivača topline (HEXENER) voditeljice prof. dr. sc. Anice Trp.

*The members of the Department are involved in the work of a research project financed by the Croatian Science Foundation entitled Enhancement of the heat exchanger energy efficiency (HEXENER), project leader Anica Trp, D. Sc.*

**PROJEKTI | PROJECTS**

- Povećanje energetske učinkovitosti izmjenjivača topline (HEXENER), istraživački projekt financiran od Hrvatske zaklade za znanost, 2017.-2021., voditeljica projekta prof. dr. sc. Anica Trp.  
*Enhancement of the heat exchanger energy efficiency (HEXENER), research project financed by the Croatian Science Foundation, 2017-2021, project leader Prof. Anica Trp, D. Sc.*
- Akumulacija i izmjena toplinske energije u sustavima obnovljivih izvora energije, potpora znanstvenim istraživanjima Sveučilišta u Rijeci, voditeljica prof. dr. sc. Anica Trp.  
*Thermal energy storage and heat transfer in a renewable energy systems, support for scientific research, University of Rijeka, head prof. Anica Trp, D. Sc.*
- Optimizacija dizalica topline i rashladnih sustava koji koriste radne tvari niskog utjecaja na globalno zatopljenje korištenjem numeričkih simulacija, potpora znanstvenim istraživanjima Sveučilišta u Rijeci, voditelj prof. dr. sc. Branimir Pavković.  
*Optimization of heat pumps and refrigeration systems with low global warming potential refrigerants using numerical simulation, support for scientific research, University of Rijeka, head prof. Branimir Pavković, D. Sc.*

**PUBLIKACIJE | PUBLICATIONS****RADOVI U ČASOPISIMA | JOURNAL PAPERS**

- Kirinčić, M.; Trp, A.; Lenić, K., Numerical evaluation of the latent heat thermal energy storage performance enhancement by installing longitudinal fins, *Journal of Energy Storage*, ISSN: 2352-152X, 42, 103085, 202, 2021, Elsevier



- Kirinčić, M.; Trp, A.; Lenić, K., *Influence of natural convection during melting and solidification of paraffin in a longitudinally finned shell-and-tube latent thermal energy storage on the applicability of developed numerical models*, *Renewable Energy*, ISSN: 0960-1481, 179, 1329-1344, 2021, Elsevier
- Blecich, P.; Trp, A.; Lenić, K., *Thermal performance analysis of fin-and-tube heat exchangers operating with airflow nonuniformity* *International Journal of Thermal Sciences*, ISSN: 1290-0729 164, 106887, 2021, Elsevier
- Mađerčić, D.; Čarija, Z.; Pavković, B.; Delač, B., *Experimental and numerical study on water ice forming on pipe columns in a limited-volume storage*, *Applied thermal engineering*, ISSN: 1359-4311, 194, 117080, 2021, Elsevier
- Tramošljika, B.; Blecich, P.; Bonefačić, I.; Glažar, V., *Advanced ultra-supercritical coal-fired power plant with post-combustion carbon capture: analysis of electricity penalty and CO2 emission reduction*, *Sustainability*, 2071-1050, 2(13), 801-821, 2021, Switzerland
- Tramošljika, B.; Blecich, P.; Bonefačić, I., *Post-combustion CO2 capture for coal power plants: a viable solution for decarbonization of the power industry?*, *International Scientific Journal Innovations, Print (2603-3763), Online (2603-3771)*, 1(9), 30-33, 2021, Bulgaria
- Pelić, V.; Mrakovčić, T.; Medica-Viola, V.; Valčić, M., *Effect of Early Closing of the Inlet Valve on Fuel Consumption and Temperature in a Medium Speed Marine Diesel Engine Cylinder* *Journal of Marine Science and Engineering*, ISSN: 2077-1312, 8(10), 747, 2020, Basel, Švicarska
- Pelić, V.; Mrakovčić, T.; Radonja, R.; Valčić, M., *Analysis of the Impact of Split Injection on Fuel Consumption and NOx Emissions of Marine Medium-Speed Diesel Engine*, *Journal of Marine Science and Engineering*, ISSN: 2077-1312, 8(10), 820, 2020, Basel, Švicarska
- Lorencin, I.; Anđelić, N.; Baressi Šegota, S.; Štifanić, D.; Musulin, J.; Mrzljak, V.; Markova-Car, E.; Car, Z., *Dataset Size-Based Approach In Design Of Artificial Neural Network For Breast Cancer Diagnosis*, *World of Health*, ISSN: 2623-5773, 3, 13-19, 2020, Rijeka
- Baressi Šegota, S.; Lorencin, I.; Anđelić, N.; Mrzljak, V.; Car, Z., *Improvement of Marine Steam Turbine Conventional Exergy Analysis by Neural Network Application*, *Journal of Marine Science and Engineering*, ISSN: 2077-1312, 8 (11), 1-38, 2020, Basel, Švicarska
- Mrzljak, V.; Baressi Šegota, S.; Meštrić, H.; Car, Z., *Comparison of Power Distribution, Losses and Efficiencies of a Steam Turbine with and without Extractions*, *Tehnički glasnik - Technical journal*, ISSN: 1846-6168 14 (4), 480-487, 2020, Koprivnica
- Mrzljak, V.; Poljak, I.; Prpić-Oršić, J.; Jelić, M., *Exergy analysis of marine waste heat recovery CO2 closed-cycle gas turbine system*, *Pomorstvo*, ISSN: 1332-0718, 34 (2), 309-322, 2020 Rijeka
- Anđelić, N.; Mrzljak, V.; Lorencin, I.; Baressi Šegota, S., *Comparison of Exergy and Various Energy Analysis Methods for a Main Marine Steam Turbine at Different Loads*, *Pomorski zbornik*, ISSN: 0554-6397 59, (1), 9-34, 2020, Rijeka
- Anđelić, N.; Baressi Šegota, S.; Lorencin, I.; Mrzljak, V.; Car, Z., *Estimation of COVID-19 epidemic curves using genetic programming algorithm*, *Health informatics journal*, ISSN: 1460-4582, 27 (1), 1-40, 2021, London, Velika Britanija
- Lorencin, I.; Baressi Šegota, S.; Anđelić, N.; Mrzljak, V.; Čabov, T.; Španjol, J.; Car, Z., *On Urinary Bladder Cancer Diagnosis: Utilization of Deep Convolutional Generative Adversarial Networks for Data Augmentation*, *Biology*, ISSN: 2079-7737, 10(3), 1-27, 2021, Basel, Švicarska
- Mrzljak, V.; Lorencin, I.; Anđelić, N.; Car, Z., *Thermodynamic Analysis of a Condensate Heating System from a Marine Steam Propulsion Plant with Steam Reheating*, *Journal of Marine*

- Science and Application*, ISSN: 1671-9433, 20, 117-127, 2021, Berlin, Njemačka
- Anđelić, N.; Baressi Šegota, S.; Lorencin, I.; Poljak, I.; Mrzljak, V.; Car, Z., *Use of Genetic Programming for the Estimation of CODLAG Propulsion System Parameters* *Journal of Marine Science and Engineering*, ISSN: 2077-1312, 9 (6), 1-31, 2021, Basel, Švicarska
- Mrzljak, V.; Anđelić, N.; Lorencin, I.; Baressi Šegota, S., *The influence of various optimization algorithms on nuclear power plant steam turbine exergy efficiency and destruction*, *Pomorstvo*, ISSN: 1332-0718, 35 (1), 69-86, 2021, Rijeka
- Gospić, I.; Glavan, I.; Poljak, I.; Mrzljak, V., *Energy, Economic and Environmental Effects of the Marine Diesel Engine Trigeneration Energy Systems*, *Journal of Marine Science and Engineering*, ISSN: 2077-1312, 9 (7), 1-32, 2021, Basel, Švicarska
- Mrzljak, V.; Kudláček, J.; Baressi Šegota, S.; Medica-Viola, V., *Energy and Exergy Analysis of Waste Heat Recovery Closed-Cycle Gas Turbine System while Operating with Different Mediums*, *Pomorski zbornik*, ISSN: 0554-6397, 60 (1), 21-48, 2021, Rijeka
- Baressi Šegota, S.; Anđelić, N.; Mrzljak, V.; Lorencin, I.; Kuric, I.; Car, Z., *Utilization of multilayer perceptron for determining the inverse kinematics of an industrial robotic manipulator*, *International Journal of Advanced Robotic Systems*, ISSN: 1729-8814, 1-11, 2021, London, Velika Britanija

## MEĐUNARODNI KONGRESI | INTERNATIONAL CONGRESSES

- Torbarina, F.; Trp, A.; Lenić, K.; Kirinčić, M.; Delač, B., *Modelling of Heat Pump System with Air and Solar Heat Sources Including Latent Thermal Energy Storage*, *Proceedings of World Renewable Energy Congress (WREC) 2020*, 2021, Lisabon, Portugal
- Kirinčić, M.; Trp, A.; Lenić, K.; Torbarina, F., *Latent thermal energy storage charging and discharging: a numerical study*, *Book of Abstracts of the ENERSTOCK 2021*, 82-83, 2021, Ljubljana, Slovenija
- Mrzljak, V.; Lorencin, I.; Anđelić, N.; Baressi Šegota, S., *Comparison of three methods for the pump energy analysis*, *IV INTERNATIONAL SCIENTIFIC CONFERENCE MATHEMATICAL MODELING 2020 - PROCEEDINGS* ISSN: 2535-0978, 1, 5-8, 2020, Sofija, Bugarska
- Mrzljak, V.; Lorencin, I.; Anđelić, N.; Car, Z., *Dual-flow dissymmetrical low pressure steam turbine energy analysis – comparison of both turbine cylinders*, *V INTERNATIONAL SCIENTIFIC CONFERENCE "INDUSTRY 4.0" - PROCEEDINGS 2020*, ISSN: 2535-0153, 3, 119-122, 2020, Sofija, Bugarska
- Lorencin, I.; Štifanić, D.; Musulin, J.; Mrzljak, V., *Energy and exergy evaluation of CO2 closed-cycle gas turbine*, *V INTERNATIONAL SCIENTIFIC CONFERENCE "INDUSTRY 4.0" - PROCEEDINGS 2020*, ISSN: 2535-0153, 3, 123-126, 2020, Sofija, Bugarska
- Mrzljak, V.; Prpić-Oršić, J.; Poljak, I.; Anđelić, N., *Determination of energy loss and efficiency for the low power steam turbine and each of its segments*, *VI INTERNATIONAL SCIENTIFIC CONFERENCE - HIGH TECHNOLOGIES. BUSINESS. SOCIETY. - PROCEEDINGS - 2021*, ISSN: 2535-0005, 1, 8-12, 2021, Sofija, Bugarska
- Mrzljak, V.; Prpić-Oršić, J.; Poljak, I.; Lorencin, I., *Energy and exergy losses analysis of back-pressure steam turbine from chp plant*, *XIV INTERNATIONAL CONFERENCE FOR YOUNG RESEARCHERS TECHNICAL SCIENCES. INDUSTRIAL MANAGEMENT - PROCEEDINGS - 2021* ISSN: 2535-0196, 1, 3-6, 2021, Sofija, Bugarska
- Mrzljak, V.; Prpić-Oršić, J.; Poljak, I.; Baressi Šegota, S., *Efficiencies and losses comparison of three steam turbines – from conventional, nuclear and marine power plant*, *XVIII INTERNATIONAL SCIENTIFIC CONGRESS MACHINES. TECHNOLOGIES. MATERIALS - PROCEEDINGS - 2021*, ISSN: 2535-0021, 1, 5-9, 2021, Sofija, Bugarska

- Mrzljak, V.; Prpić-Oršić, J.; Medica-Viola, V.; Senčić T., Exergy analysis of base and optimized high pressure feed water heating system from nuclear power plant IX International Scientific Conference TECHNICS. TECHNOLOGIES. EDUCATION. SAFETY. 2021 - PROCEEDINGS, ISSN: 2535-0315, 1, 5-8, 2021, Sofija, Bugarska
- Salma, D.; Mrzljak, V., Comparison of open and closed gas turbine cycles, Proceedings of the International Scientific Student Conference RI-STEM-2021, ISBN: 978-953-8246-22-7, 1, 121-128, 2021, Rijeka
- Poljančić, D.; Mrzljak, V., Energy and exergy analysis of a nuclear power plant, Proceedings of the International Scientific Student Conference RI-STEM-2021, ISBN: 978-953-8246-22-7, 1, 39-46, 2021, Rijeka
- Kadi, L.; Mrzljak, V., Efficiencies and losses comparison of various turbofan engines for aircraft propulsion, Proceedings of the International Scientific Student Conference RI-STEM-2021, ISBN: 978-953-8246-22-7, 1, 63-70, 2021, Rijeka
- Marjanović, D.; Mrzljak, V., CO2 emissions calculation from steam generator during combustion of different fuel types, Proceedings of the International Scientific Student Conference RI-STEM-2021, ISBN: 978-953-8246-22-7, 1, 147-152, 2021, Rijeka
- Mrzljak, V.; Prpić-Oršić, J.; Lorencin, I.; Anđelić, N., Exergy analysis of three cylinder steam turbine from supercritical coal-fired power plant, XXIX INTERNATIONAL SCIENTIFIC CONFERENCE trans&MOTAUTO '21 - PROCEEDINGS, ISSN: 1313-5031, 1, 92-95, 2021, Sofija, Bugarska
- Mrzljak, V.; Prpić-Oršić, J.; Poljak, I.; Baressi Šegota, S., Efficiency and loss analysis of main steam condenser from nuclear power plant at various loads and ambient temperatures, VI INTERNATIONAL SCIENTIFIC CONFERENCE SUMMER SESSION 2021 INDUSTRY 4.0 - PROCEEDINGS, ISSN: 2535-0153, 1, 45-48, 2021, Sofija, Bugarska
- Car, Z.; Baressi Šegota, S.; Anđelić, N.; Lorencin, I.; Musulin, J.; Štifanić, D.; Mrzljak, V., Determining Inverse Kinematics of a Serial Robotic Manipulator Through the Use of Genetic Programming Algorithm, 8th International Congress of Serbian Society of Mechanics, 1, 1-6, 2021, Kragujevac, Srbija

#### MEĐUNARODNA SURADNJA | INTERNATIONAL COLLABORATIONS

- Dipartimento di energetica, Università degli studi di Trieste, Italija, Italy
- Dipartimento di energetica, Politecnico di Milano, Italija, Italy
- EURAMMON - a joint initiative by companies, institutions and individuals committed to increasing the use of natural refrigerants, Frankfurt, Njemačka, Germany
- Faculty of Mechanical Engineering, University of Ljubljana, Slovenija, Slovenia
- GRETh, Bâtiment Lynx, SavoieTechnolac, Le Bourget du Lac – Cedex, Francuska, France
- Institute of Energy Technology, ETH Zürich, Švicarska, Switzerland
- International Institute of Refrigeration, Paris, Francuska, France
- ISES – The International Solar Energy Society, Freiburg, World Organisation, Germany/ Njemačka ISES Europe Freiburg, Njemačka, Germany
- Laboratory for Heating, Sanitary and Solar Technology, University of Ljubljana, Slovenija, Slovenia
- Research and Development Center, Compagnie Industrielle d'Applications Thermiques (CIAT), Culoz, Francuska, France



# SLUŽBE

DEKANAT, TAJNIŠTVO

RAČUNALNI CENTAR

STUDENTSKA EVIDENCIJA

KNJIŽNICA

## 6 STRUČNE SLUŽBE PROFESSIONAL AND ADMINISTRATIVE STAFF



# 6.1 KNJIŽNICA LIBRARY



**Sanja Orešković** prof. i dipl. knjižničarka prof., grad. librarian

*voditeljica*  
*head*



**mr. sc. Mario Šlosar-Brnelić** dipl. knjižničar grad. librarian



256

Knjižnica Tehničkog fakulteta Sveučilišta u Rijeci dio je znanstvene, istraživačke i obrazovne djelatnosti Fakulteta. Obavlja poslove oblikovanja i izgradnje knjižničkog fonda (nabava, stručna obrada), pružanja knjižničnih usluga korisnicima (posudba i korištenje građe, informacijsko-edukacijsku djelatnost) i ostale poslove koji proizlaze iz tih procesa.

Korisnici knjižnice su redovni i izvanredni studenti, nastavno osoblje i stručni suradnici Fakulteta, ali i ostali članovi šire društvene zajednice koji se bave znanstvenim i stručnim radom, a usluge knjižnice koriste po posebnim uvjetima. Knjižnica funkcionira kao informacijsko, izobrazbeno i komunikacijsko središte. Nalazi se u prizemlju zgrade Fakulteta, gdje su na 403 m<sup>2</sup>, na dvije etaže, smještene čitaonica, računalna čitaonica i otvoreni i zatvoreni fond.

Čitaonica se sastoji od trideset i tri mjesta za učenje i korištenje prijenosnih računala s priključcima na mrežu. Računalna čitaonica ima dvadeset i četiri mjesta s jedanaest računala namijenjenih istraživanju i učenju; preko njih studenti imaju pristup bazama podataka i katalozima svih knjižnica. Modernizacijom knjižničkoga sustava Knjižnica je integrirana u knjižnični sustav Sveučilišta u Rijeci, dodano je niz novih funkcio-

The Library of the Faculty of Engineering of the University of Rijeka is part of the scientific, research and educational activities of the Faculty. It performs the tasks of designing and building up the library collection (procurement, expertise), providing library services to users (the loan and use of materials, and providing information and educational activities), and other related matters.

The Library is used by the full and part-time students and professional staff of the Faculty, but also other members of the wider community engaged in scientific and professional work, who use the Library's facilities under special conditions. The Library functions as a media, education and communication centre. It is located on the ground floor of the Faculty, over two floors covering 403 m<sup>2</sup>. These feature a Reading Room, Computer Reading Room, and an Open and Closed Collection. The Reading Room consists of thirty-three places for learning and using laptop computers, with connections to a network. The Computer Reading Room has twenty-four places with eleven computers intended for research and learning. These provide students with access to the licensed databases and catalogues of all the libraries.

nalnosti i usluga i omogućeno je pretraživanje svih baza kroz jedan sustav. Pomoću Discovery servisa, jedinstvenog sučelja za pretraživanje, omogućeno je pretraživanje skupnog kataloga Sveučilišta, čime i kataloga svih knjižnica Sveučilišta, pretplaćenih baza podataka dostupnih na Fakultetu i Sveučilištu u Rijeci, portala znanstvenih časopisa RH HRČAK i drugih odabranih znanstvenih izvora u slobodnom pristupu na internetu. Od 2016. godine svi završni, diplomski i doktorski radovi, kao i ostale vrste digitalnih objekata, koji su rezultat znanstvenoistraživačkog, intelektualnog i kreativnog rada povezanih s Fakultetom, pohranjuju se u digitalnom repozitoriju Dabar i slobodno su dostupni svim ovlaštenim korisnicima.

Knjižnični fond Knjižnice je svojim sadržajem i obimom prilagođen znanstvenoistraživačkom programu rada na Fakultetu. Kontinuirano se dopunjava, obnavlja i osuvremenjuje pri čemu se težište stavlja na nabavu literature iz tehničkih znanosti, elektrotehnike, brodogradnje, računarstva. Početkom 2020. godine, knjižnični fond iznosi oko 22000 svezaka omeđenih publikacija i oko 750 naslova domaćih i stranih periodičkih publikacija. Uz klasičnu posudbu tiskane građe, pridaje se pažnja i pretraživanju i odabiru relevantne građe prema individualnim potrebama korisnika kao i njihovoj edukaciji za samostalno pretraživanje izvora informacija. Knjižnica, prema zahtjevima korisnika, vrši usluge i međuknjižnične posudbe.

Uključeni smo u sustav upravljanja kvalitetom ISO 9001.

With the recent modernisation of the library system, the Library has been integrated into the library system of the University of Rijeka, and a number of new features and services have been added and searches of databases through a single system enabled. Using the Discovery Service as a unified search interface, it is now possible to search not only the Union University Catalogue but also the catalogues of all the libraries of the University, subscribed databases available at the Faculty and the University of Rijeka, the central portal of Croatian scientific journals (RH HRČAK), and other selected scientific resources freely accessible on the internet. Since 2016, all final, graduate and doctoral theses, as well as other types of digital objects that are the result of scientific research, and intellectual and creative work related to the Faculty, are stored in the Dabar digital repository and are freely available to all authorised users.

The Library collection, in terms of its funding sources, content and scope, is adjusted to the scientific research programme of the Faculty. It has been continuously complemented, renewed and modernised, with the emphasis being placed on the acquisition of literature in engineering sciences, electrical engineering, naval architecture and computing. In early 2020, the library collection comprised some 22,000 volumes and 750 titles of domestic and foreign periodicals. However, apart from lending classical printed materials, due attention is also given to searching for and selecting relevant material for the individual needs of users and their education. The Library also provides interlibrary loans to meet the requirements of its users.

It is worth pointing out that the Library has an ISO 9001 standard quality management system.



257

## 6.2 RAČUNALNI CENTAR COMPUTER CENTER



**Domagoj Crljenko**, dipl. ing. m.eng.

*vođitelj  
head*



**Damir Koščić**, dipl. ing. m.eng.

*stručni suradnik  
associate*



**Tatjana Škorjanc**, dipl. ing. m.eng.

*stručni suradnik  
associate*



**Siniša Vukotić**

*tehnički suradnik  
associate*

### RAČUNALNI KABINETI

- Računalni kabinet 1: 20 + 1 računalo
- Računalni kabinet 2: 20 + 1 računalo
- Računalni kabinet 3: 20 + 1 računalo
- Računalni kabinet 4: 16 + 1 računalo
- Računalni kabinet 5: 10 + 1 računalo
- Računalni kabinet 6: 20 + 1 računalo
- Računalni kabinet 7: 20 + 1 računalo
- Računalni kabinet 8: 20 + 1 računalo

### COMPUTER CLASSROOMS

- Computer Classroom 1: 20 + 1 computers
- Computer Classroom 2: 20 + 1 computers
- Computer Classroom 3: 20 + 1 computers
- Computer Classroom 4: 16 + 1 computers
- Computer Classroom 5: 10 + 1 computers
- Computer Classroom 6: 20 + 1 computers
- Computer Classroom 7: 20 + 1 computers
- Computer Classroom 8: 20 + 1 computers



# 6.3 FINANCIJSKA SLUŽBA

## ACCOUNTING DIVISION



**Ana Mirković Pavlović**, mag. oec. grad. economist  
*voditeljica*  
*head*



**Goran Brodarac**, mag. oec. grad. economist  
*računovodstveni poslovi*  
*accounting activities*



**Ariana Gregur**, dipl.oec. grad. economist  
*financijski poslovi*  
*financial activities*



**Ana Šutalo**, struc. spec. oec. spec. grad. economist  
*financijski poslovi*  
*financial activities*

Financijska služba obavlja financijske i računovodstvene poslove. Financijska služba vodi računa o zakonitosti financijskog poslovanja, obavlja sve isplate vezane uz plaće, autorske honorare i ugovore o djelu, kontrolira, obračunava i isplaćuje putne naloge, plaća račune u tuzemstvu i inozemstvu, knjiži na računima glavne knjige sve poslovne događaje, sastavlja prijedlog financijskog plana Fakulteta te mjesečne, tromjesečne, polugodišnje i godišnje izvještaje, kontaktira s Ministarstvom znanosti i obrazovanja, Sveučilištem u Rijeci, Poreznom upravom, FINA-om, Revizijom, bankama i usklađuje svoje poslovanje i izvještaje s tim subjektima iz okruženja.

The accounting division performs financial and accounting activities. Specifically, it takes into account the legality of the financial business and performs all payments related to salaries, author's fees and work contracts. Furthermore, the accounting division controls, calculates and pays travel orders, pays domestic and foreign accounts, records all business events in the ledger accounts, compiles the proposal of the Faculty's financial plan as well as the monthly, quarterly, semi-annual and annual reports. It also maintains contact with the Ministry of Science and Education, the University of Rijeka, the Tax Office, the Financial Administration, the Audit, the banks and it coordinates its own business and reports with all these entities from the area.

## 6.4 SLUŽBA NABAVE I KOMERCIJALE

### PROCUREMENT AND COMMERCIALE OFFICE

## 6.5 SLUŽBA OPĆIH I KADROVSKIH POSLOVA

### GENERAL AND PERSONNEL OFFICE



**Robert Mohorić,**  
dipl. oec. grad. economist

*voditelj*  
*head*



**Tijana Čupurdija,**  
mag. oec. grad. economist

*ekonom za inventar*  
*inventory economist*



**Bruna Martinović,**  
mag. oec. grad. economist

*ekonom za inventar*  
*inventory economist*



**Mladen Ostrogović,**  
mag. oec. grad. economist

*ekonom za potrošni materijal*  
*economist for consumables*

Služba obavlja poslove komercijale, nabave i ekonomata. Vodi poslove u vezi nabave roba, usluga i radova, izradom plana nabave robe, usluga i radova za tekuću godinu, priprema i provodi postupke odabira godišnjih dobavljača, vodi evidenciju nabave male i velike vrijednosti, administrativno provodi postupke nabave prema Zakonu o javnoj nabavi, priprema dokumentaciju ovisno o načinu nabave, kontaktira s dobavljačima, sudjeluje u pripremanju odluka i prijedloga ugovora, pohranjuje cjelokupnu dokumentaciju o nabavi, preuzima naručenu robu, vodi evidenciju o sitnom inventaru, osnovnim sredstvima i potrošnom materijalu, radi na izradi, održavanju i unapređenju baza podataka Službe te održava i unapređuje sustav kontrole kvalitete u Službi.

Skriptarnica je u zakupu firme TEHNIČAR COPYSERVIS d.o.o., Zagreb.

This office performs commercial, procurement and economic services. It runs services connected with the procurement of goods and services, prepares and implements the procedures for the annual selection of suppliers, contracts with suppliers, receives ordered goods, keeps records of small inventories, basic resources and consumables, works on the office's databases and maintains and improves the system of quality control of its services.

The copy shop is leased by the firm TEHNIČAR COPYSERVIS Ltd, Zagreb.

**Snježana Mikuličić**

*voditeljica kadrovskih poslova*  
*personnel operation manager*



#### TAJNICE ZAVODA | DEPARTMENT SECRETARY:

**Valnea Burić Marohnić,**  
mag. cult.



**Tina Kažić Tadić,**  
struč. spec. eoc  
spec. grad. economist.



**Ivana Petrović**



**Marijana Burić Redžović,**  
dipl. iur. grad.law.

*voditeljica opće i kadrovske službe*  
*general and personnel office head*



**Lidija Petričić**  
*administrativna tajnica*  
*administrative secretary*



**Natalija Forgić**



**Lovorka Malinić**



**Patricija Vukić**



SPREMAČICE | CLEANING STAFF:



Snježana Ban



Marica Gnjatović



Marina Djaković



Mirjana Košpić



Valentina Kajfeš



Julijana Nenadović



## 6.6 SLUŽBA STUDENTSKE EVIDENCIJE

### STUDENT'S REGISTRAR AND AFFAIRS OFFICE

## 6.7 TEHNIČKA SLUŽBA

### TEHNICAL AND MAINTENANCE SERVICES



**Žarko Burić,**  
mag. ing. m.eng.

*voditelj*  
head



**Antonela Čaleta**

*voditelj ostalih*  
*ustrojstvenih jedinica*  
head of other  
organizational units



**Tanja Veljčić**

*voditelj odsjeka III*  
head of department III



**Adriana Muždeka Prodanović,**  
univ. spec. oec.

*voditelj ostalih ustrojstvenih jedinica*  
head of other organizational units



**Irina Ćosić,**  
dip.ing. m.eng.

*stručni savjetnik ISVU*  
ISVU Advisor

**Elvis Krulčić,**  
dip.ing. m.eng.

*voditelj*  
head



**Josip Jurasic**



**Frane Polegubić,**  
struč.spec.ing.sec.



**Bernardo Badurina,**  
bacc.ing. bacc.eng.



**Andrej Miljuš**



266

Služba studentske evidencije Fakulteta obavlja sve poslove vezane uz potrebe studenata. Zaprima i obrađuje dokumentaciju za razredbeni postupak, obavlja upis studenata u prvu i u više studijske godine, priprema dokumentaciju studenata za završni ili diplomski ispit, organizira promocije završenih studenata, prima i izdaje razne zahtjeve, uvjerenja i potvrde, izrađuje izvješća prostručne analize za potrebe Fakulteta te vodi potrebnu korespondenciju i daje izvješća zainteresiranim strankama.

The students' Registrar and Affairs Office is in charge of all the issues pertaining to students' needs. It collects and manages documentation for the admission exams, manages the enrolment of students to all the study years, prepares students' documents for the graduation exams, organizes the commencement of graduates, receives and delivers various requests and certificates, produces reports and analyses as per Faculty need, manages the necessary correspondence and gives reports to interested parties.



267

#### DOMARI - KUĆEPAZITELJI | MAJOR - DOMO

**Miljenko Pujic**



Tehnička služba obavlja poslove održavanja, zaštite na radu, zaštite od požara uz sustavno unaprjeđenje sustava kvalitete i ekologije. U sastavu Tehničke službe su i laboranti koji pod nadzorom nastavnika sudjeluju u pripremi, odnosno izvedbi dijela nastave.

The Technical and Maintenance Services perform activities pertaining to maintenance, work safety and fire protection. Involved in the Technical Services are also laboratory technicians that, under supervision of teaching staff, participate in the preparation of performing parts of lectures.

**Boris Šegota**





# 7 STUDENTSKE AKTIVNOSTI

## STUDENT ACTIVITIES

## 7.1 STUDENTSKI ZBOR TEHNIČKOG FAKULTETA

### STUDENT COUNCIL AT THE FACULTY OF ENGINEERING



Studentski zbor Tehničkog fakulteta u Rijeci je najviše predstavničko tijelo studenata unutar Fakulteta. Rad Studentskog zbora definiran je Statutom Studentskoga zbora u kojemu su navedene i sljedeće zadaće: biranje studentskog predstavnika u Skupštinu pri Studentskom zboru Sveučilišta u Rijeci, biranje studentskih predstavnika u radna tijela Fakulteta i sudjelovanje u radu i odlučivanju tih tijela, briga o kvaliteti života studenata, a posebice o kvaliteti studijskog procesa, studentskom standardu, ostvarivanju studentskih prava i drugim pitanjima važnim za studente Fakulteta, predlaganje plana financiranja studentskih aktivnosti nadležnim tijelima Fakulteta, poticanje izvannastavnih aktivnosti studenata Fakulteta i obavljanje drugih poslova od interesa studenata Fakulteta

The Student Council of the Faculty of Engineering in Rijeka is the highest representative body of the students in the Faculty. Its work is defined by the Statute of the Student Council, in which the following activities are mentioned: the election of student representative to the Student Council of the University of Rijeka, the election of student representatives who are actively involved in the work of the Faculty Council, participating in decision-making, care for the quality of students' lives, especially the quality of study programmes, the student standard, the realisation of students' rights, and other issues of relevance to the students of the Faculty, proposing the funding plan for student activities to the competent authorities, promoting extracurricular activities of the students of the Faculty, and any other activity of interest to the students of the Faculty.





## ČLANOVI STUDENTSKOG ZBORA PO IZBORNIM JEDINICAMA

### MEMBERS, LISTED BY ELECTORIAL WARDS

#### I. PREDDIPLOMSKI SVEUČILIŠNI, DIPLOMSKI SVEUČILIŠNI I PREDDIPLOMSKI STRUČNI STUDIJU STROJARSTVA I BRODOGRADNJE

#### I. UNDERGRADUATE, GRADUATE AND UNDERGRADUATE VOCATIONAL STUDIES OF MECHANICAL ENGINEERING AND NAVAL ARCHITECTURE

##### PREDSTAVNIK | REPRESENTATIVE

- » *Mihael Čuže*
- » *Alen Gačić*  
(Predstavnik u SZSUR  
/ Representative in the Student Council of  
the University of Rijeka)
- » *Roberto Koren*
- » *Danijel Marjanović*
- » *Tina Mlinarić- tajnica*
- » *Ana Vlahović*
- » *Dario Džapo*
- » *Noa Poklepović*

##### ZAMJENIK | DEPUTY

- » *Rino Žeželić*
- » *Katarina Krizanović*
- » *Josip Črep*
- » *Josip Horvat*
- » *Karlo Težak*
- » *Natali Pauković*
- » *Michele Gerometta*
- » *Franko Antić*

#### II. PREDDIPLOMSKI SVEUČILIŠNI I DIPLOMSKI SVEUČILIŠNI STUDIJU ELEKTROTEHNIKE I RAČUNARSTVA I PREDDIPLOMSKI STRUČNI STUDIJU ELEKTROTEHNIKE

#### II. UNDERGRADUATE AND GRADUATE STUDIES OF ELECTRICAL ENGINEERING AND COMPUTING AND UNDERGRADUATE VOCATIONAL STUDIES OF ELECTRICAL ENGINEERING

##### PREDSTAVNIK | REPRESENTATIVE

- » *Marina Banov*  
(potpredsjednica / vice president)
- » *Antonio Barišić*
- » *Ivan Buterin*  
(predsjednik / president)
- » *Dean Krbavac*
- » *Lana Miličević*  
(studentska pravobraniteljica  
/ Student ombudsman)
- » *Romario Novak*
- » *Biagio Mazzone*
- » *Arian Čarapina*

##### ZAMJENIK | DEPUTY

- » *Valentina Ecmović*
- » *Jakov Petrović*
- » *Leon Samardžić*
- » *Nenad Busić*
- » *Karlo Džafić*
- » *Luka Repušić*
- » *Ivan Jandrić*
- » *David Valentić*

#### III. POSLIJEDIPLOMSKI SVEUČILIŠNI (DOKTORSKI) STUDIJU

#### III. POSTGRADUATE DOCTORAL STUDIES IN THE AREA OF ENGINEERING SCIENCES

##### PREDSTAVNIK | REPRESENTATIVE

- » *Sandi Baressi Šegota*
- » *Jelena Musulin*

##### ZAMJENIK | DEPUTY

- » *Ivan Lorenčin*
- » *Daniel Štifanić*



## 7.2 IEEE STUDENTSKI OGRANAK SVEUČILIŠTA U RIJECI

### IEEE UNIVERSITY OF RIJEKA STUDENT BRANCH

IEEE studentski ogranak Sveučilišta u Rijeci nastao je 2006. godine kao jedan od studentskih ograna unutar Hrvatske sekcije IEEE. Cilj mu je okupljanje studenata iz različitih područja tehničkih znanosti i organizacija raznovrsnih događanja. Zbog toga se pod okriljem Ogranaka održavaju predavanja iz područja tehničkih znanosti, natjecanja, radionice i razna druženja. Time se studentima omogućuje razmjena ideja i iskustava, sklapanje niza korisnih poznanstava, ali i nerazdvojenih prijateljstava. Sve to vodi boljoj umreženosti i napretku na privatnom i poslovnom planu svake osobe.

Studentski ogranak u Rijeci je tijekom godina otvorio i dva podograna i društva unutar IEEE-a. Podgranci koji djeluju u sklopu ogranaka su Computer Society (CS) kojeg čine uglavnom studenti računarstva i Power and Energy Society (PES) koji okuplja studente elektrotehnike i energetike, uz koje imamo i aktivno Young Professionals (YP) društvo.

Studentski ogranak provodi brojne aktivnosti svake godine, neke od njih bit će predstavljene u nastavku teksta.

#### Organizirane aktivnosti

Od 2015. godine provodimo Pripremni seminar iz programiranja koji se održava u zadnjem tjednu rujna, prije samog početka akademske godine. Cilj seminara je upoznavanje studenata prve godine studija na Tehničkom fakultetu u Rijeci s osnovnim znanjem iz programiranja. Na taj način studenti su spremniji pristupiti zadacima s kojima se susreću već u prvom semestru. Seminar je održan i ove godine, u suradnji sa Zavodom za računarstvo Tehničkog fakulteta, pod vodstvom članova Studentskog ogranaka Rijeka.

The IEEE student branch of the University of Rijeka was established in 2006 as one of the student branches of the Croatian section of the IEEE. Its goal is to bring together students from different fields in technical sciences and to organise various events. Under the auspices of the Branch, lectures in the field of technical sciences, competitions, workshops and various gatherings are held. This enables students to exchange ideas and experiences, and make useful acquaintances but also inseparable friendships. All this leads to better networking and progress in the private and business life of each person.

Over the years, the Student Branch in Rijeka has opened two sub-branches of the society as part of the IEEE. The sub-branches that operate within the branch are the Computer Society (CS), which consists mainly of computer science students, and the Power and Energy Society (PES), which brings together students of electrical engineering and energetics, who have an active Young Professionals (YP) society.

The student branch conducts a number of activities each year, some of which are presented below.

#### Organised activities

Since 2015, we have conducted a Preparatory Seminar in Programming, which takes place in the last week of September, before the beginning of the academic year. The aim of the seminar is to acquaint first year students at the Technical Faculty in Rijeka with a basic knowledge of programming. In this way, students are more willing to approach the tasks they face in the

**IEEE**  
Advancing Technology  
for Humanity

IEEE STUDENTSKI OGRANAK SVEUČILIŠTA U RIJECI

KONTAKT:  
IEEE.SBRI@GMAIL.COM  
IEEE SB RIJEKA | FACEBOOK

## Success stories

27. Veljače 2020.  
12:00



DINO ILIĆ  
Microsoft



IVANA ŽUŽIĆ  
Google SWA Intern



Pridruži nam se i saznaj kako je raditi u nekim od najvećih firmi svijeta!

Svake godine se trudimo organizirati predavanja u kojima promoviramo nove i zanimljive tehnologije. Success Stories (Priče o uspjehnosti) su predavanja koja drže nekadašnji i sadašnji studenti Tehničkog fakulteta Sveučilišta u Rijeci. Studenti - predavači pobliže objašnjavaju svoja iskustva, bilo da je to otvaranje svoje tvrtke, rad u nekoj od najvećih tvrtki poput Googlea i Microsofita ili praksa izvan Hrvatske. Cilj predavanja je prenijeti svoja iskustva, prepričati razne zgode i nezgode, kako bi studenti iz prve ruke čuli kako mogu ostvariti svoje ciljeve obogaćeni iskustvima koja do sada nisu imali priliku čuti.

27. 02. 2020. na Tehničkom fakultetu u Rijeci održano je prvo takvo predavanje, a predavači su bili Dino Ilić koji radi u Microsoftu u Norveškoj i Ivana Žužić koja je sudjelovala u Googleovim internshipovima.

#### Natjecanja

IEEE studentski ogranak Rijeka, zajedno s Tehničkim fakultetom u Rijeci, sudjelovao je u organizaciji Google Hash Code huba održanom na Tehničkom fakultetu 20. veljače. RITEH hub je organiziran u suradnji s ostalim studentima fakulteta, a svrha mu je okupljanje studenata, natjecatelja koji se žele okušati u jednom od najpopularnijih programskih natjecanja - Google Hash Code.

#### Suradnja

IEEE Studentski ogranak Sveučilišta u Rijeci aktivno surađuje s ostalim ograncima u Hrvatskoj u unapređenju kvalitete i sadržaja aktivnosti na razini Hrvatske sekcije IEEE- a. Osim što blisko surađujemo s ostalim članovima IEEE-a, na lokalnoj razini surađujemo s brojnim drugim studentskim udrugama, organizacijama, fakultetima i tvrtkama. Rezultat suradnje je bolja umreženost naših članova s drugim aktivnim grupama, ali i

first semester. The seminar was held this year in cooperation with the Department of Computer Science of the Technical Faculty, under the leadership of members of the Student Branch of Rijeka. Every year, we try to organise lectures in which we promote new and interesting technologies. Success Stories are lectures given by former and current students of the Technical Faculty of the University of Rijeka. The same students, and lecturers, explain their experiences in more detail, whether it is opening your own company, working in one of the largest companies such as Google or Microsoft, or internships outside Croatia. The aim of the lectures is to recount experiences and incidents, and also accidents, so that students hear firsthand how they can achieve some of their goals and also hear about experiences that they have not had the opportunity to find out about before.

On 27 February 2020, the first such lecture was held at the Technical Faculty in Rijeka, and the lecturers were Dino Ilić, who works at Microsoft in Norway, and Ivana Žužić, who has participated in Google internships.

#### Competitions

The IEEE organises competitions for its student members. The most popular team programming competition is Google Hash, a global team programming competition. It is held annually, at the beginning of the year (around February), and our members have been competing for years. In order for the teams to have the best possible working conditions, the branch prepares a common room for them at the Technical Faculty every year, where they have access to other necessary equipment in addition to computer equipment. We also treat them to food and drinks. In the last three years, another IEEE competition has been promoted, which is IEEE MaC, a competition in mobile application development. For four years



bolji i kvalitetniji sadržaj kojega možemo ponuditi studentima, bolja promocija aktivnosti i veća posjećenost. Neke od naših suradnji kroz prošlu i ovu godinu su sa Studentskim zborom Tehničkog fakulteta i Studentskim zborom Sveučilišta u Rijeci s kojima smo, između ostaloga, organizirali Computer Society Congress kongres, Alumni Tehničkog fakulteta s kojima smo organizirali stručna predavanja i ostali.

#### Ostale aktivnosti

Osim aktivnosti koje sami organiziramo, naši članovi imaju priliku posjetiti brojne aktivnosti koje su organizirali ostali ogranci u Hrvatskoj, a to su razni kongresi, stručna predavanja, radionice, svečane večere i slično.

#### Promocija

Upoznavanje studenata s radom Studentskog ogranka i IEEE-a aktivnost je od posebne važnosti. S obzirom na neprofitnost i volontersku dimenziju naše udruge, aktivnosti koje se organiziraju ovise o vremenu i volji članova ogranka. Stoga je, radi opstanka i nastavka rada ogranka, potrebno imati aktivno članstvo. Najbolja promocija našeg rada je kroz aktivnosti koje organiziramo. Postoji i poseban dan početkom listopada kada se na razini IEEE-a promovira cjelokupni rad organizacije, IEEE Day. Tada obilježavamo dan IEEE tako što upoznajemo naše studente, a posebno bruoše, o samom radu studentskog ogranka Sveučilišta u Rijeci, a cilj je privući što više novih članova kako bi studenti postali dijelom ove velike svjetske zajednice.

Sve naše aktivnosti pronađite na našoj Facebook stranici ([www.facebook.com/ieeesbrijeka](http://www.facebook.com/ieeesbrijeka)) i službenoj IEEE stranici Hrvatske sekcije ([www.ieee.hr](http://www.ieee.hr)) gdje objavljujemo najave novih događaja, slike i osvrte na održane aktivnosti.

now, our members have been part of a team of ambassadors who promote the competition, offer training and compete in their own right. This year, our members signed up and came joint first in the world with their conference app.

#### Cooperation

The IEEE Student Branch of the University of Rijeka actively cooperates with other branches in Croatia, and improves the quality and content of activities at the level of the Croatian section of the IEEE. In addition to working closely with other IEEE members, we work with a number of other student associations, organisations, colleges, and firms locally. The result of this cooperation is better networking of our members with other active groups of people, but also better and higher quality content that we can offer students, better promotion of activities, and higher attendance. Some of our collaborators in the past, and also this year, have included the Student Union of the Technical Faculty and the Student Union of the University of Rijeka, with whom we have organised, among other things, our Computer Society Congress, and the Alumni of the Technical Faculty, with whom we have organised professional lectures.

#### Other activities

In addition to the activities we organise ourselves, our members have the opportunity to attend numerous events organised by other branches in Croatia, such as various congresses, professional lectures, workshops, gala dinners, and the like.

#### Promotion

Introducing students to the work of the Student Branch and IEEE activities is of particular importance. As we are a non-profit voluntary association, the activities that are organised depend on the time and will that the members of the branch have, so it is necessary to have an active membership in order to survive and continue the work of the branch. The best promotion of our work is through the activities that we organise, but there is also a special day in early October when the IEEE promotes the entire work of the organisation. We celebrate IEEE Day by introducing our students, especially freshmen, to the work of the student branch of the University of Rijeka. Our goal is to attract as many new members as possible to make students part of these large international communities.

Find all our activities on our Facebook page ([www.facebook.com/ieeesbrijeka](http://www.facebook.com/ieeesbrijeka)) and the official IEEE page of the Croatian section ([www.ieee.hr](http://www.ieee.hr)), where we publish announcements of new events, and also pictures and reviews of our activities.

## 7.3 NATJECANJE TIMOVA STUDENATA INFORMATIČARA HRVATSKIH SVEUČILIŠTA 2020

### CROATIAN COLLEGIATE PROGRAMMING CONTEST 2020

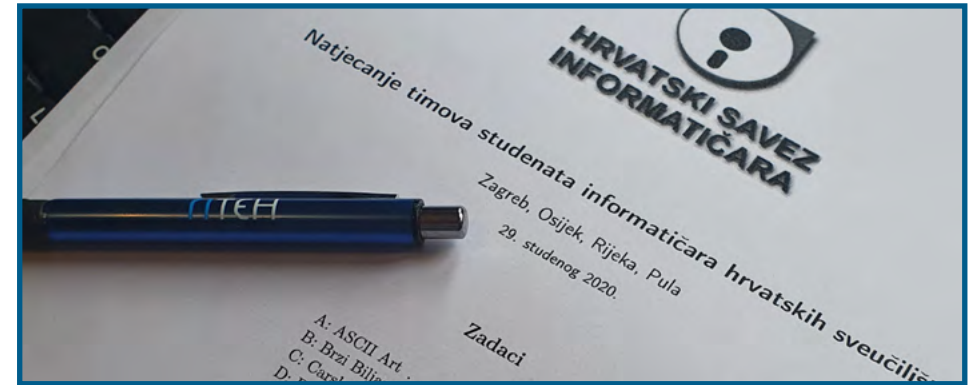

Natjecanje timova studenata informatičara već dulji niz godina organizira Hrvatski savez informatičara (HSIN), kao izlučni dio u procesu stjecanja prava sudjelovanja na svjetskom studentskom natjecanju u programiranju ICPC (International Collegiate Programming Contest). Tročlani timovi koji predstavljaju svoje sveučilište rade na rješavanju složenih problema, čime se potiče suradnja, kreativnost, inovativnost i sposobnost nastupa pod pritiskom. Radi se o najstarijem, najvećem i najprestižnijem natjecanju u programiranju na svijetu.

Natjecanje se sastoji od rješavanja 8 do 10 zadataka u vremenskom periodu od 5 sati. Programski jezici u kojima studenti mogu pokazati svoje znanje prilikom rješavanja problemskih zadataka su Python, C/C++ i Java na Linux platformi.

Zadatke za natjecanje i sustav za vrednovanje natjecateljskih rješenja osigurava Hrvatski savez informatičara. Prostor za natjecanje, kao i cjelokupnu organizaciju u kontekstu Sveučilišta u Rijeci, uobičajeno osigurava Tehnički fakultet, premda se ove godine, u kontekstu COVID-19, natjecanje održalo na daljinu.

Ove akademske godine natjecanje se održalo u nedjelju, 29. studenog 2020. U službenoj konkurenciji od 14 timova na razini Hrvatske sudjelovala su i dva studentska tima sa Sveučilišta u Rijeci. Tim studenata Tehničkog fakulteta u sastavu Matija Dizdar, Jakov Tomasić i Lucija Žužić, kao prvorangirani sa Sveučilišta u Rijeci, kvalificirao se na Central Europe Regional Contest (CERC 2020) koji će se održati u rujnu 2021. godine.

The Croatian Collegiate Programming Contest has been organised for many years by the Croatian Computer Science Association (CCSA) as part of the process of acquiring the right to participate in the worldwide ICPC (International Collegiate Programming Contest) programming competition. Teams of three, representing their university, work to solve complex problems, fostering collaboration, creativity, innovation, and the ability to perform under pressure. It is the oldest, largest and most prestigious programming contest in the world.

The competition consists of solving 8 to 10 problems over a period of 5 hours. The programming languages which students can utilise in order to demonstrate their skills in solving problem tasks are Python, C/C++ and Java on the Linux platform.

The problem tasks and the system for automatic evaluation of submitted solutions are both provided by the Croatian Computer Science Association. The competition venue, as well as the entire organisation as far as the University of Rijeka is concerned, is usually provided by the Faculty of Engineering, although this year, due to COVID-19, the competition was held online.

This academic year, the contest was held on Sunday 29 November 2020. Two student teams from the University of Rijeka participated with another 12 Croatian teams in the official competition. The students of the Faculty of Engineering, Matija Dizdar, Jakov Tomasić and Lucija Žužić, as the highest-ranked team from the University of Rijeka, qualified for the Central Europe Regional Contest (CERC 2020), which will take place in September 2021.



## 7.4 RITEH RACING TEAM



Riteh Racing Team ove je sezone imao jak start. Novi RRC6 bolid bio je konstruiran i spreman za proizvodnju, intelektualne sposobnosti članova tima su mu na predsezonskim kvizovima osigurala mjesto na prestižnim natjecanjima u Mađarskoj i Austriji, a simulacije su predviđele najbrži bolid Riteh Racing Teama do sad.

Globalna kovid kriza se nije slagala s tim planovima. Brojni članovi tima nisu iz okolice Rijeke, a potaknuti online odvijanjem nastave, ove sezone nisu boravili u Rijeci. Zbog toga je nedostajalo ruku za izradu dijelova od kompozita ojačanih karbonskim vlaknima i za sklapanje bolida. Bližili su se rokovi natjecanja, a nas je čekalo još puno posla. Brojni suradnici koji su nas pratili i bili uz nas kroz cijeli ovaj projekt, također pogođeni krizom, potrudili su se, koliko je bilo u njihovoj moći, ostati uz nas. No, karte su se tako posložile pa smo nakon dugo vremena zapisali svoj neuspjeh. Ali, kako to obično i biva, nakon kiše dolazi sunce, pa će tako i ovaj naš projekt biti osvjetljen novim ciljevima i uspjesima.

Usprkos ovogodišnjem izostanku bolida, kojega možemo shvatiti kao pauzu i priliku za još jači i bolji povratak, tim

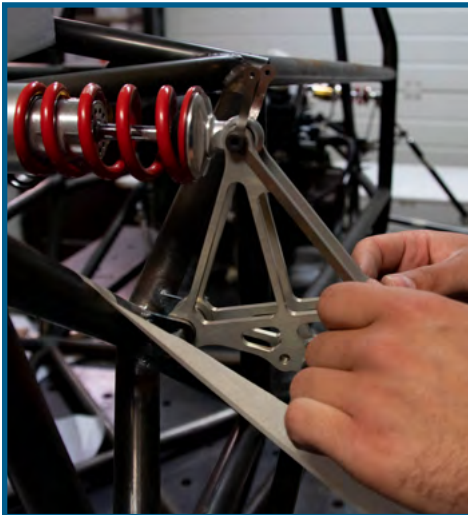

The Riteh Racing Team had a great start to the season. The new RRC6 race car was designed and ready for production, the intellectual skills of team members had secured them a spot in prestigious competitions in Hungary and Austria, and simulations had predicted that the RRC6 could be the fastest Riteh Racing Team formula to date.

However, the Global Covid crisis had other plans. Many team members are not residents of Rijeka, and with classes being held online, they had no reason to stay in Rijeka. For that reason, the team lacked manpower to manufacture components made of carbon fibre reinforced plastic and to assemble the car. Deadlines were getting closer, and tasks were piling up. Many of our closest associates who had been helping the team from the very start had been struck by the crisis as well. The dice had fallen badly and, after a long period of success, we had to admit failure. However, as so often happens, after the rain there comes a rainbow. This project is expected to shine brightly again soon, inspired by new goals and future ac-

je ipak značajno napredovao u razvoju električnog bolida. Električna vozila se polako prestaju smatrati budućnošću autoindustrije i postaju dio današnjice.

Riteh Racing Team ponosno predstavlja odluku o uključenoje u globalni pokret elektrifikacije svojim novim projektom i bolidom RRCe. Razvijen je plan projekta, inženjerski je analiziran problem i odabrano je konstrukcijsko rješenje novog bolida koje će se razraditi u sljedećoj sezoni.

Kao podlogu za naš budući razvoj, iskoristili smo mogućnost odlaska na Formula Student Alpe Adria natjecanje u Novom Marofu. Riječ je o trećem Formula Student događaju u Hrvatskoj

complishments.

Despite the fact that no new car was produced this year, the team made significant progress in the development of a future electric race car project. Electric vehicles are being regarded less and less as the future of the car industry and are increasingly being incorporated into everyday life.

The Riteh Racing Team is proud to announce its decision to join the global EV movement with its new RRCe project and car. The project plan has already been developed, the engineering problem has been analysed, and the design solution, which will be further developed during the





i o prvom u Varaždinskoj županiji u organizaciji varaždinske Udruge FSAA, koja uključuje i naše bivše kolege iz Riteh Racing Teama. Odlučili smo podržati svoje kolege u ovom projektu i odlaskom na natjecanje razmijeniti znanja i iskustva s vodećim europskim timovima kako bismo unaprijedili svoj budući rad.

Iskoristili bismo priliku i ovim putem zahvalili se fakultetu, sponzorima i svima koji su nas podržavali u našem radu i omogućili nam temelje za ostvarivanje budućih ciljeva. Iako smo i sami doživjeli razočaranje zbog nepravilnosti u kojima smo se našli, čvrsto smo odlučili ići dalje i pokazati na djelu svoje znanje, napor, rad i trud. Nadamo se da će svi oni koji su nas do sad podržavali ostati uz nas, a naša neizmjerena zahvalnost oslikat će se novim uspjesima. Pobjednici nikad ne odustaju!

next season, has been chosen.

As a foundation for our future growth, we attended the Formula Student Alpe Adria competition in Novi Marof in August this year. It's the third Formula Student event in Croatia in a row and the first in Varaždin County, and was organised by the FSAA association, which includes former Riteh Racing Team members. We have decided to support our former colleagues in this project and exchange knowledge with leading European teams in an effort to improve our future work.

We would like to take this opportunity to thank the University, our sponsors and everyone who supported our project and laid the foundations for the accomplishment of our future goals. Although we experienced a disappointing last season, we have decided to boldly go forward and show our strength, our knowledge, experience and persistence. We hope that all our supporters will stay with us in our future work. We will show our immense gratitude with our future accomplishments. Winners never give up!

## 7.5 RITEH DRONE TEAM

RiTeH Drone Team je studentski projekt koji djeluje pod mentorstvom izv. prof. dr. sc. Kristijana Lenca i asistenta Franka Hrzića te već petu godinu radi na ostvarenju projekata vezanih za bespilotne letjelice. RiTeH Drone Team osnovali su u lipnju 2016. godine tri studenta: Domagoj Poljančić, Gordan Nekić i Franko Hrzić.

Istraživačka sekcija RiTeH Drone Teama fokusira se na istraživanje i razvoj tehnologija vezanih za autonomnu vožnju i pozicioniranje dronova u geografskom prostoru. Trkaća sekcija RiTeH Drone Teama ima svoj primarni fokus na istraživanju, primjeni i unaprjeđenju trkaćih dronova i poligona i na sudjelovanju u utrkama dronova.

Ove smo godine radili na dva veća projekta. Mateo Srića radio je na projektu pod imenom „Pronalazak i stacioniranje vrata trkaće staze za bespilotne letjelice“. Istražio je i implementirao sustav za postavljanje trkaćeg poligona u bilo kojoj prostori uz održavanje originalnog razmaka između vrata, bez obzira na prostor i izgled prostori-je. Deni Klen je radio na projektu pod imenom „Upravljanje Tello dronom“ razviviši algoritam i softver za autonomno upravljanje letjelice Tello kroz spomenuti poligon.

Ujedno smo nastavili suradnju s Hrvatskom agencijom za civilno zrakoplovstvo u educiranju šire javnosti o upotrebi dronova unutar Republike Hrvatske i u edukaciji učenika srednjih škola u korištenju bespilotnih letjelica. Sudjelovali smo u aktivnostima Studentskog zbora Sveučilišta u Rijeci i bili podrška u istraživanjima na Tehničkom fakultetu.

Svojoj opremi dodali smo nekoliko neophodnih dijelova za bolje i naprednije korištenje već postojećih dronova, DJI Tello drone, nekoliko minidronova za edukaciju novih članova i pripremu članova za upravljanje trkaćim dronovima.

Trenutno radimo na još nekoliko manjih studentskih projekata i regrutiranju novih članova.

Kroz sljedeću godinu planiramo raditi na povećanju obje sekcije, osnivanju fotografske sekcije RiTeH Drone Teama, istraživanju autonomnosti bespilotnih letjelica i pružanju podrške budućim istraživanjima fakulteta.



RiTeH Drone Team is a student project mentored by Associate Professor Kristijan Lenac and Assistant Franko Hrzić, which has been working on the realisation of projects related to unmanned aerial vehicles for five years. RiTeH Drone Team was founded in June 2016 by three students:

Domagoj Poljančić, Gordan Nekić and Franko Hrzić.

The research department of RiTeH Drone Team focuses on the research and development of technologies for autonomous driving and positioning of drones in geographic space. The racing division of RiTeH Drone Team focuses primarily on the research, application and improvement of racing drones and polygons, as well as participation in drone races.

This year, we worked on two major projects. Mateo Srića worked on a project called "Pronalazak i stacioniranje vrata trkaće staze za

bespilotne letjelice", in which he implemented a system to set up a race track in any room, keeping the original distance between doors, regardless of the space and room layout. Deni Klen worked on a project called Tello Drone Control, where he developed algorithms and software for autonomous control of the Tello spacecraft through a racing polygon.

At the same time, we continued our cooperation with the Croatian Civil Aviation Agency in educating the public about the use of drones in the Republic of Croatia and in training high school students in the use of unmanned aerial vehicles. We participated in the activities of the

Student Union of the University of Rijeka and supported the research of the Faculty of Engineering.

We expanded our equipment with certain necessary parts for better and more advanced use of existing drones, but also DJI Tello drones, and a pair of

mini drones to train new members and prepare members to operate racing drones.

We are currently working on several student projects and recruiting new members.

In the next year, we plan to grow both sections, add a drone team photography section, explore drone autonomy, and support faculty research.



## 7.6 RITEH WEB TEAM



Riteh Web Team je osnovan krajem 2014. godine pod vodstvom doc. dr. sc. Damira Arbule i doc. dr. sc. Sandija Ljubića. Osnovni ciljevi rada tima su razmjena iskustava i znanja među studentima i mentorski rad kroz sastanke, radionice i revizije programskih kodova, a prije svega stjecanje iskustva u izradi web i mobilnih aplikacija: od ideje, prikupljanja specifikacija, osmišljavanja arhitekture i razvoja do produkcijske razine i puštanja u rad.

Tim je inicijalno okupljen oko tri projekta: sustava za upravljanje sadržajem weba Tehničkog fakulteta, web aplikacije za automatizirano vrednovanje rješenja zadataka (na predmetima kao što su Programiranje, Algoritmi i strukture podataka i Baze podataka), te sustava Navindo za navigaciju u zatvorenim prostorima.

Web i mobilne aplikacije koje razvijaju članovi tima teže korištenju najmodernijih tehnologija i razvojnih metoda.

Kroz rad tima nastale su brojne zanimljive web aplikacije, od kojih se, osim već spomenutih, može izdvojiti sustav Ticketing kojega aktivno koriste zaposlenici Tehničkog fakulteta, primarno za potrebe rada Tehničke službe i Računalnog centra. Sustav Ticketing omogućuje zaposlenicima fakulteta prijavu određenog problema nakon čega ga preuzimaju relevantne službe zadužene za rješavanje, a čiji agenti putem sustava mogu komunicirati i obavijestiti sve zainteresirane strane o trenutnom stanju problema i postupku rješavanja.

Mnogi studenti uključuju se u rad tima kroz projekte te završne i diplomske radove u kojima

The Riteh Web Team was founded in late 2014 under the leadership of Assistant Professor Damir Arbula D.Sc and Assistant Professor Sandi Ljubić D.Sc. The main goals of the team's work are exchanging experience and knowledge among students, mentoring through meetings and workshops, code reviews and, most importantly, gaining experience in web and mobile application development from the idea, assembly specifications, and designing the architecture, right the way through to the production level, and finally release.

The team initially focused on three projects: (1) a web content management system for the Faculty of Engineering website; (2) a web application for the automated evaluation of task solutions (for classes such as Programming, Algorithms and Data Structures, and Database Systems); (3) the Navindo system for indoor navigation.

The team members strive to use the latest technologies and development methods in the web and mobile applications they develop.

As a result of the team's work, many interesting web applications have been created. Apart from those mentioned above, we can also point out the Ticketing system, which has been actively used by the employees of the Faculty of Engineering, primarily for the needs of the Technical/Maintenance Service and Computing Centre. The Ticketing system allows faculty employees to enter a specific problem which is solved by the relevant department. Moreover, department agents can communicate through the system and notify all interested parties of the current state of the problem and the procedure

imaju prilike raditi na rješavanju stvarnih problema putem najnovijih tehnologija, uz mentoriranje profesora i starijih studenata koji su u timu već više godina. Studenti tako stječu vrijedno radno iskustvo koje mogu istaknuti u svojim životopisima.

Kvaliteta studenata koji su bili članovi tima dokazana je kroz njihove uspjehe na raznim programerskim natjecanjima i ostvarenim praksama i zaposlenjima u vodećim IT tvrtkama, poput Googlea i Microsofta.

Akademski godinu 2021./2022. bila je zahtjevna po mnogočemu, a u kontekstu pandemije COVID-19 broj potencijalnih događaja, kao što su natjecanja i stručne konferencije, bio je sveden na minimum. Članovi tima tradicionalno su sudjelovali na natjecanju Google Hash Code, ali zbog specifičnih uvjeta ove godine nije bilo moguće organizirati događaj na samom fakultetu. Također, i natjecanje timova studenata informatičara hrvatskih sveučilišta ove se godine nije održalo u prostorima fakulteta, ali su članovi tima uspješno sudjelovali online. Studenti, članovi tima, ove su se godine po prvi puta okušali u tipu natjecanja „Capture The Flag“. U tom natjecanju posebna se pozornost daje sigurnosti računalnih

being undertaken to solve it.

Many students take part in the team's work through projects, and bachelors' and masters' theses, which provide them with the opportunity to work on real problems, using the latest technologies, and to be mentored by professors and older students who have been members of the team for many years. In this process, they gain valuable work experience which can be used in their CVs.

The quality of student members of the team has been demonstrated through their success in various programming competitions and in their work placements and employment in leading IT companies, such as Google and Microsoft.

The 2021-2 academic year was demanding in many ways, and due to the COVID-19 pandemic, many events such as competitions and conferences were cancelled or postponed. Team members have traditionally competed in the Google Hash Code contest, but due to the specific conditions this year it was not possible to organise the event at the faculty. Similarly, the university collegiate programming contest was not held on the faculty premises this





sustava, a izazovi u natjecanju potiču kreativnost i korištenje stečenog znanja s ciljem probijanja zadanog sigurnosnog sustava.

Iako stručne konferencije većinom nije bilo moguće pohađati na licu mjesta, članovi tima sudjelovali su u online formatu na konferenciji .debug. Imali su prilike čuti više od pedeset predavanja na tri različite virtualne pozornice, a najistaknutije predavanje održao je Mate Rimac koji je govorio o dvanaest najtežih mjeseci u stvaranju Rimac Automobila.

Približavanjem ljeta započela su i događanja uživo. Tako je u srpnju na Tehničkom Fakultetu organizirana „Ljetna škola digitalne obrade slike“ u kojoj su studenti imali prilike slušati predavanja relevantnih stručnjaka i okušati se u izradi i prezentaciji zanimljivih projekata. Više članova Riteh Web Teama sudjelovalo je u ljetnoj školi, a Barbara Breš bila je dio pobjedničkog tima koji je osvojio prvu nagradu.

year. However, team members successfully participated online. This year, students took part in a "Capture The Flag" contest for the first time. In this competition, special attention is paid to the security of computer systems, with challenges that encourage creativity and the use of acquired knowledge with the goal of breaking through a given security system.

Although it was generally not possible to attend conferences on site, team members participated in an online format at the .debug conference. They had the opportunity to follow more than 50 talks on 3 different virtual stages, with the most significant lecture being given by Mate Rimac, who spoke about the 12 toughest months in "Rimac Automobili".

As summer approached, on-site events started to take place. In July, the "Summer School on Image Processing" was organised at the Faculty of Engineering, which gave students the opportunity to listen to lectures by experts but also to be actively involved in interesting projects. Several members of the Riteh Web Team participated in the summer school, and Barbara Breš was part of the team that won first prize.

